

Denomination and application

Order no. PU Trade price € excl. VAT SU DG per PU ¹⁾

Cordless drills

Cordless drill CXS

you can find the compatible batteries and chargers available as accessories under "Battery and charging technology"



Cordless drill, CXS 2,6-Plus

2 x battery pack BP-XS (500184), charger MXC (497495), CENTROTEC tool chuck (492135), CENTROTEC BH 60 CE Imp magnetic bit holder (498974), FastFix keyless chuck 10 mm (499949), bit PZ 2, belt clip, Systainer SYS3 M 137 (204841)

576092 1 245,00 1 101010



Cordless drill, CXS 2,6-Set

2 x battery pack BP-XS (500184), charger MXC (497495), CENTROTEC tool chuck (492135), CENTROTEC BH 60 CE Imp magnetic bit holder (498974), FastFix keyless chuck 10 mm (499949), XS elbow adapter (497951), bit PZ 2, belt clip, Systainer SYS3 M 137 (204841)

576093 1 307,00 1 101010

Cordless drill TXS

you can find the compatible batteries and chargers available as accessories under "Battery and charging technology"



Cordless drill, TXS 2,6-Plus

2 x battery pack BP-XS (500184), charger MXC (497495), CENTROTEC tool chuck (492135), CENTROTEC BH 60 CE Imp magnetic bit holder (498974), FastFix keyless chuck 10 mm (499949), bit PZ 2, belt clip, Systainer SYS3 M 137 (204841)

576101 1 245,00 1 101010



Cordless drill, TXS 2,6-Set

2 x battery pack BP-XS (500184), charger MXC (497495), CENTROTEC tool chuck (492135), CENTROTEC BH 60 CE Imp magnetic bit holder (498974), FastFix keyless chuck 10 mm (499949), XS elbow adapter (497951), bit PZ 2, belt clip, Systainer SYS3 M 137 (204841)

576102 1 307,00 1 101010

C 18 cordless drill

you can find the compatible batteries and chargers available as accessories under "Battery and charging technology"



Cordless drill, C 18-Basic

without battery pack, without charger, CENTROTEC tool chuck (492135), CENTROTEC BH 60 CE Imp magnetic bit holder (498974), FastFix keyless chuck 13 mm KC 13-1/2-K-FFP (769067), bit PZ 2, belt clip, Systainer SYS3 M 187 (204842)

576434 1 254,00 1 101001



Cordless drill, C 18 C 3,1-Plus

2 x BP 18 Li 3.1 C battery pack (201789), rapid charger TCL 6 (201135), CENTROTEC tool chuck (492135), CENTROTEC BH 60 CE Imp magnetic bit holder (498974), FastFix keyless chuck 13 mm KC 13-1/2-K-FFP (769067), bit PZ 2, belt clip, Systainer SYS3 M 187 (204842)

576437 1 466,00 1 101001

Drilling and screwdriving

Denomination and application		Order no.	PU	Trade price € excl. VAT per PU ¹⁾	SU	DG
Cordless drill T 18+3						
you can find the compatible batteries and chargers available as accessories under "Battery and charging technology"						
	Cordless drill, T 18+3-Basic without battery pack, without charger, CENTROTEC tool chuck (492135), CENTROTEC BH 60 CE Imp magnetic bit holder (498974), FastFix keyless chuck 13 mm KC 13-1/2-K-FFP (769067), bit PZ 2, belt clip, Systainer SYS3 M 187 (204842)	576448	1	254,00	1	101001
	Cordless drill, T 18+3 C 3,1-Plus 2 x BP 18 Li 3.1 C battery pack (201789), rapid charger TCL 6 (201135), CENTROTEC tool chuck (492135), CENTROTEC BH 60 CE Imp magnetic bit holder (498974), FastFix keyless chuck 13 mm KC 13-1/2-K-FFP (769067), bit PZ 2, belt clip, Systainer SYS3 M 187 (204842)	576449	1	466,00	1	101001
TDC 18/4 cordless drill						
	Cordless drill QUADRIVE, TDC 18/4 I-Basic without battery pack, without charger, CENTROTEC tool chuck (492135), CENTROTEC BH 60 CE Imp magnetic bit holder (498974), FastFix keyless chuck 13 mm KC 13-1/2-MMFP (577072), bit PZ 2, additional side-mounted hand grip (577073), belt clip, Systainer SYS3 M 187 (204842)	575601	1	304,00	1	101001
	Cordless percussion drill QUADRIVE, TPC 18/4 I-Basic without battery pack, without charger, CENTROTEC tool chuck (492135), CENTROTEC BH 60 CE Imp magnetic bit holder (498974), FastFix keyless chuck 13 mm KC 13-1/2-MMFP (577072), bit PZ 2, additional side-mounted hand grip (577073), belt clip, Systainer SYS3 M 187 (204842)	575604	1	315,00	1	101002
Cordless percussion drills						
TPC 18/4 cordless percussion drill						
	Cordless percussion drill QUADRIVE, TPC 18/4 I-Basic without battery pack, without charger, CENTROTEC tool chuck (492135), CENTROTEC BH 60 CE Imp magnetic bit holder (498974), FastFix keyless chuck 13 mm KC 13-1/2-MMFP (577072), bit PZ 2, additional side-mounted hand grip (577073), belt clip, Systainer SYS3 M 187 (204842)	575604	1	315,00	1	101002
	Cordless impact driver, TID 18 C 3,1-Plus 2 x BP 18 Li 3.1 C battery pack (201789), rapid charger TCL 6 (201135), belt clip, Systainer SYS3 M 187 (204842)	576485	1	512,00	1	101007
Cordless impact driver						
TID 18 cordless impact driver						
you can find the compatible batteries and chargers available as accessories under "Battery and charging technology"						
	Cordless impact driver, TID 18-Basic without battery pack, without charger, belt clip, Systainer SYS3 M 187 (204842)	576481	1	300,00	1	101007
	Cordless impact driver, TID 18 C 3,1-Plus 2 x BP 18 Li 3.1 C battery pack (201789), rapid charger TCL 6 (201135), belt clip, Systainer SYS3 M 187 (204842)	576485	1	512,00	1	101007
	Cordless impact driver, TID 18-Basic without battery pack, without charger, belt clip, Systainer SYS3 M 187 (204842)	576481	1	300,00	1	101007
	Cordless impact driver, TID 18 C 3,1-Plus 2 x BP 18 Li 3.1 C battery pack (201789), rapid charger TCL 6 (201135), belt clip, Systainer SYS3 M 187 (204842)	576485	1	512,00	1	101007





* Attention: Festool products with Bluetooth® technology are not available in all countries.
For more information, please contact the official local Festool import partner.
You can find the overview regarding our products and our partners worldwide on our website www.festool.com

PU = Packaging Units
SU = Shipping Units

¹⁾ Manufacturer's recommended retail price.
Dealer prices may vary.

Drilling and screwdriving

Denomination and application	Order no.	PU	Trade price		
			€ excl. VAT	SU	DG
Screwdriver and drill bit set you can find the compatible batteries and chargers available as accessories under "Battery and charging technology"					
	576492	1	725,00	1	101007
Screwdriver and drill bit set, TID 18 C 3,1-Set T18 TID 18 cordless impact driver, T18+3 cordless drills, 2 x BP 18 Li 3.1 C battery pack (201789), rapid charger TCL 6 (201135), FastFix keyless chuck 13 mm KC 13-1/2-K-FFP (769067), belt clip, Systainer SYS3 M 237 (204843)					

Bit assortment and bit holders					
	204381	1	27,40	1	501001
Bit cassette, BT-IMP SORT1 for TID 18 cordless impact screwdriver; extra-impact-resistant bit assortment; 6-pc.; in the BitBOX; bit holder BH 52, bit PZ 2, TX 20 bit, TX 25 bit, TX 30 bit, TX 40 bit length 25 mm					
	204383	1	42,10	1	501001
Bit cassette, BT-IMP SORT3 for TID 18 cordless impact screwdriver; extra-impact-resistant bit assortment; 6-pc.; in the BitBOX; BHS 50 lockable magnetic bit holder, bit PZ 2, TX 20 bit, TX 25 bit, TX 30 bit, TX 40 bit length 25 mm					
	204385	1	44,20	1	501001
Bit cassette, BT-IMP SORT5 for TID 18 cordless impact screwdriver; extra-impact-resistant bit assortment; 6-pc.; in bit check; with 1/4" hexagonal drive; bit PZ 2, PH 2 bit, TX 20 bit, TX 25 bit, TX 30 bit, TX 40 bit length 50 mm					
	204388	3	45,20	1	501001
Socket spanner, STSL-IMP 1/4"-Set for TID 18 cordless impact screwdriver; 3-piece; ideally suited for screwing in and unscrewing hexagon screws; socket spanner with 1/4" hexagonal holder with the following widths across flats: 1/4", 5/16" and 3/8" length 50 mm					

Cordless hammer drills

Cordless hammer drill BHC 18 you can find the compatible batteries and chargers available as accessories under "Battery and charging technology"					
	576511	1	331,00	1	101011
Cordless hammer drill, BHC 18-Basic without battery pack, without charger, additional side-mounted hand grip (768615), depth stop, Systainer SYS3 M 187 (204842)					

Cordless drywall screwdrivers



DURADRIVE DWC 18 cordless drywall screwdriver you can find the compatible batteries and chargers available as accessories under "Battery and charging technology"					
	576497	1	389,00	1	101009
Cordless construction screwdriver DURADRIVE, DWC 18-2500 Basic without battery pack, without charger, magazine attachment (769146), depth stop, scaffolding holder, magnetic bit holder (769125), 2 x bit PH2, long, PH 2 bit, belt clip, Systainer SYS3 M 187 (204842)					

* Attention: Festool products with Bluetooth® technology are not available in all countries.
 For more information, please contact the official local Festool import partner.
 You can find the overview regarding our products and our partners worldwide on our website www.festool.com

PU = Packaging Units
 SU = Shipping Units

¹⁾ Manufacturer's recommended retail price.
 Dealer prices may vary.



Drilling and screwdriving



Denomination and application		Order no.	PU	Trade price € excl. VAT per PU ¹⁾	SU	DG
	Cordless construction screwdriver DURADRIVE, DWC 18-2500 C 3,1-Plus 2 x BP 18 Li 3.1 C battery pack (201789), rapid charger TCL 6 (201135), magazine attachment (769146), depth stop, scaffolding holder, magnetic bit holder (769125), 2 x bit PH2, long, PH 2 bit, belt clip, Systainer SYS3 M 187 (204842)	576500	1	601,00	1	101009
	Cordless construction screwdriver DURADRIVE, DWC 18-4500 Basic without battery pack, without charger, magazine attachment (769146), depth stop, scaffolding holder, magnetic bit holder (769125), 2 x bit PH2, long, PH 2 bit, belt clip, Systainer SYS3 M 187 (204842)	576504	1	389,00	1	101009
	Cordless construction screwdriver DURADRIVE, DWC 18-4500 C 3,1-Plus 2 x BP 18 Li 3.1 C battery pack (201789), rapid charger TCL 6 (201135), magazine attachment (769146), depth stop, scaffolding holder, magnetic bit holder (769125), 2 x bit PH2, long, PH 2 bit, belt clip, Systainer SYS3 M 187 (204842)	576505	1	601,00	1	101009

Drills

QUADRILL DR drills						
	Drill QUADRILL, DR 20 E FF-Plus keyed chuck with clawed jaws and locking device (769061), telescopic auxiliary side handle (769044), depth stop, SYS Maxi (492582)	767991	1	441,00	1	101003

CENTROTEC tool chuck, keyless chuck, attachments

CENTROTEC quick tool change						
	Tool chuck, WH-CE CENTROTEC	492135	1	25,40	1	201004
	Tool chuck, CC-XL CENTROTEC for DR 20 E FF, DRP 20 ET FF, DRP 20-2 E FF; for holding CENTROTEC tools holder FastFix	769071	1	40,10	1	201004

Keyless chucks						
for clamping drills and screwdriver bits without tools						
	Keyless chuck, BF-FX 10 for Festool cordless drills CXS and TXS clamping range 1 - 10 mm; holder FastFix	499949	1	59,10	1	201004
	Keyless chuck, KC 13-1/2-K-FFP for all Festool cordless drills, cordless percussion drills, drills (except DR 20/DRP 20) and percussion drills with CENTROTEC interface holder FastFix; clamping range 1,5 - 13 mm	769067	1	62,00	1	201004

* Attention: Festool products with Bluetooth® technology are not available in all countries.
For more information, please contact the official local Festool import partner.
You can find the overview regarding our products and our partners worldwide on our website www.festool.com

PU = Packaging Units
SU = Shipping Units

¹⁾ Manufacturer's recommended retail price.
Dealer prices may vary.

Drilling and screwdriving

Denomination and application		Order no.	PU	Trade price € excl. VAT per PU ¹⁾	SU	DG
	Keyless chuck, KC 13-1/2-MMFP for all Festool cordless drills, cordless percussion drills, drills (except DR 20/DRP 20) and percussion drills with CENTROTEC interface holder FastFix; clamping range 1,5 - 13 mm	577072	1	70,90	1	201004
	Keyless chuck, BF-TI 13 for TI 15 IMPACT; chuck with integrated switch-off function for impact; enables drilling with infinite speed adjustment up to 2,600 rpm clamping range 1,5 - 13 mm	498886	1	92,50	1	201004
Key-type chuck						
	Key-type chuck, CC-16 FFP for DR 20 E FF, DRP 20 ET FF, DRP 20-2 E FF; with wrench and locking device holder FastFix; clamping range 3 - 16 mm	769061	1	128,70	1	201004
Attachments						
	Adapter, AD-1/2 FF for DR 20 E FF, DRP 20 ET FF, DRP 20-2 E FF; for quick-change adapters; For holding socket wrenches with 1/2" square holder FastFix	769062	1	72,20	1	201003
FastFix attachments						
FastFix attachments						
	Angle attachment, AN-UNI for TPC 18/4, TDC 18/4 and all Festool C and T cordless drills with FastFix fixture (except CXS/TXS); quick angle adjustment simply by rotating the green ring – the attachment no longer needs to be released from the machine Max. screw size for softwood 10 x 300 mm; holder FastFix	205222	1	135,30	1	201003
	Eccentric attachment, EX-UNI for TPC 18/4, TDC 18/4 and all Festool C and T cordless drills with FastFix fixture (except CXS/TXS); quick angle adjustment simply by rotating the green ring – the attachment no longer needs to be released from the machine Max. screw size for softwood 6 x 100 mm	205223	1	114,50	1	201003
	Adapter, AD-3/8" FF for all Festool cordless drills, cordless percussion drills, drills (except DR 20/DRP 20) and percussion drills with CENTROTEC interface; for holding socket wrenches with 3/8" square i.a.w. DIN 3121 (machine-operated assembly tools) holder FastFix	769064	1	63,10	1	201003
	Depth stop, DD-DC for TPC 18/4, TDC 18/4 and all Festool C and T cordless drills with FastFix fixture (except CXS/TXS) Max. screw size for softwood 6 x 100 mm	493539	1	113,30	1	201003
	Depth stop, DC UNI FF for all Festool cordless drills, cordless percussion drills, drills (except DR 20/DRP 20) and percussion drills with CENTROTEC interface; stop sleeves Ø 17 mm + 23 mm, PH 2 bit, socket wrench, size 8 holder FastFix; Max. screw size for softwood 6 x 100 mm	769126	1	120,70	1	201003

* Attention: Festool products with Bluetooth® technology are not available in all countries.
For more information, please contact the official local Festool import partner.
You can find the overview regarding our products and our partners worldwide on our website www.festool.com

PU = Packaging Units
SU = Shipping Units

¹⁾ Manufacturer's recommended retail price.
Dealer prices may vary.

Drilling and screwdriving

Denomination and application		Order no.	PU	Trade price € excl. VAT per PU ¹⁾	SU	DG
	Socket spanner, SW 8-DC UNI FF 2x for depth stop DC UNI FF; 2 socket wrenches SW 8 with ball clamping effect	768113	2	15,50	1	501007
	Socket spanner, SW 3/8"-DC UNI FF 2x for depth stop DC UNI FF; 2 socket wrenches SW 3/8" with ball clamping effect	768165	2	15,50	1	501007
	Guard ring, PR D17-DC UNI FF 5x for DC UNI FF; 5 protective rings for stop sleeves Ø 17 mm D 17 mm	768125	5	4,50	1	301003
	Guard ring, PR D23-DC UNI FF 5x for DC UNI FF; 5 protective rings for stop sleeve Ø 23 mm D 23 mm	768127	5	4,50	1	301003
	Angle attachment, XS-AS for CXS and TXS cordless drills; for working in tight spaces Max. screw size for softwood 5 x 40 mm	497951	1	78,10	1	201003
	Angle attachment, AU-43 FFP for DRC 18/4, PDC 18/4, DR 18/4 E, PD 20/4 E, DRP 16 ET, DRP 18-4 DEC, PDP 20-4 DEC; for absorbing higher torques holder FastFix; collar dia. 43 mm; Max. screw size for softwood 10 x 300 mm	769097	1	172,80	1	201003
	Angle chuck, AU DR 20 for DR 20 E FF, DRP 20 ET FF, DRP 20-2 E FF; for absorbing higher torques holder FastFix; collar dia. 57 mm	769060	1	209,10	1	201003
	Adapter, TI-FX for TI 15 IMPACT; FastFix adapter with integrated switch-off function for impact when using the FastFix inserts	498233	1	52,60	1	201007
	Eccentric attachment, DD-ES for all Festool C and T cordless drills with FastFix fixture (except CXS/TXS) Max. screw size for softwood 5 x 40 mm	490294	1	108,90	1	201003

* Attention: Festool products with Bluetooth® technology are not available in all countries.
For more information, please contact the official local Festool import partner.
You can find the overview regarding our products and our partners worldwide on our website www.festool.com

PU = Packaging Units
SU = Shipping Units

¹⁾ Manufacturer's recommended retail price.
Dealer prices may vary.

Drilling and screwdriving

Denomination and application	Order no.	PU	Trade price		
			€ excl. VAT	SU	DG

Other accessories for drilling and screwdriving

Accessories for cordless hammer drill BHC 18



Drilling dust nozzle, D 27-BSD

for BHC 18, PDC 18, PD 20 and mobile dust extractors CT/CTL/CTM; adapter with flexible insert; drill sleeve made from nickel-plated steel; compatible with all standard industrial and domestic vacuum cleaners; exception: must be deactivated on extractors with automatic filter cleaning system
connection dia. 27 - 32; drill bit dia. 0 - 12 mm

500483 1 22,30 1 309001



Adapter, AD SDS-plus/FastFix

for BHC 18, RHP 18, CHP 26; for holding a CENTROTEC tool chuck

769068 1 18,60 1 201007

Auxiliary handles



Auxiliary handle, AH-43/185

for all QUADRIVE DRC 18/4, PDC 18/4 and BHC 18; for absorbing higher torques
holder dia. 43 mm; length 185 mm

768615 1 11,50 1 201007



Auxiliary handle, AH-43/230

for all QUADRILL DR 18/4 and PD 20/4; for absorbing higher torques
holder dia. 43 mm; length 230 mm

768613 1 14,30 1 201007



Auxiliary handle, AHS-43/230

for QUADRIVE TPC 18/4 and TDC 18/4; for absorbing higher torques; with additional protection against accidental unscrewing
holder dia. 43 mm; length 230 mm

577073 1 14,30 1 201007



Auxiliary handle, AH-57/230

for DR 20 E FF, DRP 20 ET FF, DRP 20-2 E FF; for absorbing higher torques
holder dia. 57 mm; length 230 mm; telescopic design extendible up to 325 mm

769044 1 20,70 1 201007

Auxiliary handle, AH-57/275

for DR 20 E FF, DRP 20 ET FF, DRP 20-2 E FF; for absorbing higher torques
holder dia. 57 mm; length 275 mm; telescopic design extendible up to 380 mm

769045 1 25,80 1 201007

Accessories for drywall screwdriver DWC

Magazine attachment



Magazine attachment, AF 55-DWC

for DWC, DWP; for taped screws, 25-55 mm; bit PH2, long

769146 1 165,60 1 201003

Bits



PH 2-AF-55 3x

AF 55-DWP/DWC

Size	Length mm	Order no.	PU	€ excl. VAT	SU	DG
PH 2	152	769124	3	18,60	1	501001



PZ 2-AF-55 3x

AF 55-DWP/DWC

PZ 2	152	769078	3	18,60	1	501001
------	-----	--------	---	-------	---	--------



TX 20-AF-55/3

AF 55-DWP/DWC; processing timber construction screws loaded in a magazine (TX 20) with a length of up to 55 mm; long bits for magazine attachment; ideal for DWC 18-2500

TX 20	152	201463	3	18,60	1	501001
-------	-----	--------	---	-------	---	--------

* Attention: Festool products with Bluetooth® technology are not available in all countries.
For more information, please contact the official local Festool import partner.
You can find the overview regarding our products and our partners worldwide on our website www.festool.com

PU = Packaging Units
SU = Shipping Units

¹⁾ Manufacturer's recommended retail price.
Dealer prices may vary.

Drilling and screwdriving

Denomination and application	Order no.	PU	Trade price		
			€ excl. VAT	SU	DG

Bit holder



Bit holder, BH-DWC
for DWC, DWP

769125	1	9,80	1	501001
--------	---	------	---	--------

Drywall screws

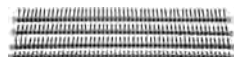

	Diameter mm	Length mm					
DWS C FT 3,9x25 1000x AF 55-DWP/DWC; magazine-loaded, 1000 pc. fine thread	3,9	25	769142	1000	34,30	1	501008
DWS C FT 3,9x35 1000x AF 55-DWP/DWC; magazine-loaded, 1000 pc. fine thread	3,9	35	769143	1000	34,30	1	501008
DWS C CT 3,9x35 1000x AF 55-DWP/DWC; magazine-loaded, 1000 pc. coarse thread	3,9	35	769144	1000	34,30	1	501008
DWS C CT 3,9x45 1000x AF 55-DWP/DWC; magazine-loaded, 1000 pc. coarse thread	3,9	45	769145	1000	34,30	1	501008

Drilling guide systems

Drill stand for carpentry

easy movement thanks to precise guide rods and bronze slide bearing in the guide block; positive stability due to the square base plate with precision-milled supporting surface; for powerful drills



Drill stand for carpentry, GD 320

centering plate for drill bits Ø 8–26 mm, 2 x depth stop, 2 x parallel side fence, adapter ring Ø 57 mm / 43 mm (768712)

768768	1	309,20	1	201005
--------	---	--------	---	--------



Drill stand for carpentry, GD 460

2 x depth stop, 2 x parallel side fence, centering plate for drill bits Ø 8–26 mm, adapter ring Ø 57 mm / 43 mm (768712)

768119	1	333,90	1	201005
--------	---	--------	---	--------



Drill stand for carpentry, GD 460 A

centering plate for drill bits Ø 8–26 mm, 2 x depth stop, 2 x parallel side fence, adapter ring Ø 57 mm / 43 mm (768712)

769042	1	435,70	1	201005
--------	---	--------	---	--------

CENTROTEC drilling tools

CENTROTEC Auger bit set



SB CE/6-Set

for TPC 18/4, TDC 18/4 and all Festool C and T cordless drills with FastFix fixture (except CXS/TXS); with CENTROTEC interface; can be sharpened up to 15 times; high corrosion resistance and low friction thanks to special coating; perfectly adapted thread enables ideal chip removal; the robust threaded tip allows the drill to be precisely positioned and draws the drill into the wood, allowing for effortless work; D 6 auger bits (205903), D 8 auger bits (205904), D 10 auger bits (205905), D 12 auger bits (205906), D 14 auger bits (205907), D 16 auger bits (205908), Systainer SYS MINI 1 TL TRA with a transparent cover (203813)

	Total length mm	Effective length mm	Diameter mm					
SB CE/6-Set	235	165	6 / 8 / 10 / 12 / 14 / 16	205902	1	134,20	1	401002

* Attention: Festool products with Bluetooth® technology are not available in all countries. For more information, please contact the official local Festool import partner. You can find the overview regarding our products and our partners worldwide on our website www.festool.com

PU = Packaging Units
SU = Shipping Units

¹⁾ Manufacturer's recommended retail price. Dealer prices may vary.

Denomination and application

Order no. PU Trade price
€ excl. VAT SU DG
per PU ¹⁾

CENTROTEC auger bit



	Total length mm	Effective length mm	Diameter mm					
SB CE D6	235	165	6	205903	1	22,90	1	401002
SB CE D8	235	165	8	205904	1	23,90	1	401002
SB CE D10	235	165	10	205905	1	24,90	1	401002
SB CE D12	235	165	12	205906	1	26,00	1	401002
SB CE D14	235	165	14	205907	1	27,00	1	401002
SB CE D16	235	165	16	205908	1	29,10	1	401002

CENTROTEC drill bits

drill bit made from high-alloy steel; with centre point and 2 cutters for drilling quick, clean holes; 2 chamfers instead of pre-cutting blades for an extended useful life, even when cutting laminated chipboard; for drilling in all types of wood, glued solid wood, MDF and acrylic glass



	Diameter mm	Length mm	Spiral length mm					
D 3 CE/W for all Festool cordless drills with FastFix interface; with CENTROTEC interface	3	73	33	492512	1	10,50	1	401002
D 4 CE/W for all Festool cordless drills with FastFix interface; with CENTROTEC interface	4	83	43	492513	1	10,50	1	401002
D 5 CE/W for all Festool cordless drills with FastFix interface; with CENTROTEC interface	5	93	51	492514	1	10,80	1	401002
D 6 CE/W for all Festool cordless drills with FastFix interface; with CENTROTEC interface	6	98	56	492515	1	11,30	1	401002
D 7 CE/W for all Festool cordless drills with FastFix interface; with CENTROTEC interface	7	109	69	492516	1	11,50	1	401002
D 8 CE/W for all Festool cordless drills with FastFix interface; with CENTROTEC interface	8	115	75	492517	1	14,00	1	401002
D 10 CE/W for all Festool cordless drills with FastFix interface; with CENTROTEC interface	10	127	88	492518	1	16,40	1	401002
BKS D 3-8 CE/W with CENTROTEC interface; long spiral wood drill bits with centring point	3, 4, 5, 6, 8	73 (Ø3)/83 (Ø4)/93 (Ø5)/98 (Ø6)/115 (Ø8)	33 (Ø3)/43 (Ø4)/51 (Ø5)/56 (Ø6)/75 (Ø8)	493648	5	52,70	1	401002



Drilling and screwdriving

Denomination and application				Order no.	PU	Trade price € excl. VAT per PU ¹⁾	SU	DG
CENTROTEC drill bits with brad point; useful length 30 mm								
	BKS D 3-8 CE/W-K with CENTROTEC interface; short spiral wood drill bits with centring point	Diameter mm	Length mm	Spiral length mm				
		3, 4, 5, 6, 8	65	25	495130	5	48,10	1 401002
	DB WOOD CE SET TL 6x with CENTROTEC interface; for processing wooden materials; made from high-quality ball bearing steel; long spiral wood drill bits with centring point	4, 2 x 5, 6, 8, 10	-	-	769093	6	62,30	1 401002
CENTROTEC deburring countersinks								
	Deburring countersink, QLS D 2- 8 CE diameter 2 - 8 mm				492520	1	32,00	1 401003
	Deburring countersink, QLS D 5-15 CE for pre-counterboring and flush screwing diameter 5 - 15 mm				492521	1	39,30	1 401003
CENTROTEC drill bit with depth stop 5mm								
	Drill bit with depth stop, BTA HW D 5 CE with CENTROTEC interface; carbide; adjustable depth stop diameter 5 mm				492522	1	46,00	1 401002
	Spare part drill bit, HW D 5 F.BTA for drill bit with depth stop; carbide diameter 5 mm				491794	1	30,80	1 401004
CENTROTEC drill countersink with depth stop 3.5mm								
	Drill countersink, BSTA HS D 3,5 CE with CENTROTEC interface; adjustable depth stop diameter 3,5 mm				492523	1	60,10	1 401003
	Spare part drill bit, EB-BSTA D 3,5/5 for drill countersink with depth stop diameter 3,5 mm				494445	5	16,00	1 401004
CENTROTEC drill countersink with depth stop of dia. 4.0 mm								
	Drill countersink, BSTA HS D 4 L60 CE for all Festool cordless drills, for use with the CENTROTEC tool chuck; with CENTROTEC interface; adjustable depth stop, especially designed for machining patio flooring diameter 4 mm; max. drill depth 60 mm				202392	1	65,80	1 401002
	Spare part drill bit, EB-BSTA D4/2 for drill countersink with depth stop; extremely long service life because the drill bit is made of high-quality HSS Böhler steel diameter 4 mm; max. drill depth 60 mm				202393	2	27,50	1 401004
CENTROTEC drill countersink with depth stop 4.5mm								
	Drill countersink, BSTA HS D 4,5 CE with CENTROTEC interface; adjustable depth stop diameter 4,5 mm				492524	1	63,30	1 401003
	Spare part drill bit, EB-BSTA D 4,5/5 for drill countersink with depth stop diameter 4,5 mm				494446	5	16,00	1 401004

* Attention: Festool products with Bluetooth® technology are not available in all countries.
For more information, please contact the official local Festool import partner.
You can find the overview regarding our products and our partners worldwide on our website www.festool.com

PU = Packaging Units
SU = Shipping Units

¹⁾ Manufacturer's recommended retail price.
Dealer prices may vary.

Drilling and screwdriving



Denomination and application		Order no.	PU	Trade price € excl. VAT per PU ¹⁾	SU	DG
CENTROTEC drill countersink with depth stop 5mm						
	Drill countersink, BSTA HS D 5 CE with CENTROTEC interface; adjustable depth stop diameter 5 mm	496451	1	66,30	1	401003
	Spare part drill bit, EB-BSTA D 5/5 for drill countersink with depth stop diameter 5 mm	496452	5	16,00	1	401004
CENTROTEC centering bit						
	Centering bit, ZB HS D 5 EURO CE with CENTROTEC interface; with depth stop for 5 mm Euro-screws diameter 5 mm	492525	1	60,10	1	401002
	Spare part drill bit, HS D 5 for centering bits diameter 5 mm	493572	1	22,60	1	401004
CENTROTEC other accessories						
	Hook driver, HD D 18 CE for all Festool cordless drills with FastFix interface; with CENTROTEC interface diameter 18 mm	492526	1	12,50	1	401003
	Drill adapter, BA-CE CENTROTEC suitable for drills; enables drills to fit FastFix attachments such as tool chuck WH-CE CENTROTEC	496450	1	20,60	1	401003
	Assembly package, SYS 1 CE-SORT for all Festool cordless drills with FastFix interface; CENTROTEC-DRIVE screwdriver handle (495228), CENTROTEC tool chuck (492135), CENTROTEC BH 60 CE Imp magnetic bit holder (498974), extra-long CENTROTEC magnetic bit holder BV 150 CE (492540), CENTROTEC drill adapter BA-CE (496450), deburring countersink QLS D2-8 CE (492520), deburring countersink QLS D5-15 CE (492521), BTA HW D5 CE drill bit with depth stop (492522), drill countersink with depth stop, BSTA HS D3.5 CE (492523), centering bit ZB HS D5 EURO CE (492525), hook driver HD D18 CE (492526), drill bit case HSS D3-10 CE/10 (495128), drill bit case BKS D3-8 CE/W-K (495130), 12x long CENTROTEC bits PZ/PH/TX, bit assortment 25 mm, 50 pieces, Systainer SYS 1 T-LOC (497563)	497628	1	453,10	1	401003
	Assembly package, SYS3 M 89 ORG CE-SORT for all Festool cordless drills with FastFix interface; D 3 CE/W spiral wood drill bits (492512), D 4 CE/W spiral wood drill bits (492513), D 5 CE/W spiral wood drill bits (492514), D 6 CE/W spiral wood drill bits (492515), D 8 CE/W spiral wood drill bits (492517), D 10 CE/W spiral wood drill bits (492518), CENTROTEC BH 60 CE Imp magnetic bit holder (498974), extra-long CENTROTEC magnetic bit holder BV 150 CE (492540), deburring countersink QLS D2-8 CE (492520), deburring countersink QLS D5-15 CE (492521), BTA HW D5 CE drill bit with depth stop (492522), drill countersink with depth stop, BSTA HS D3.5 CE (492523), centering bit ZB HS D5 EURO CE (492525), hook driver HD D18 CE (492526), twinBOX BB-MIX range of bits (496936), drill bit case BKS D3-8 CE/W-K (495130), 12 x 100 mm CENTROTEC bits PZ1/PZ2/PZ3/PH1/PH2/PH3/TX15/TX20/TX25/TX30/SZ 0.8 x 5.5/SZ 1.2 x 6.5, 60 x 25 mm bits, five units each: PZ1/PZ2/PZ3/PH1/PH2/PH3/TX10/TX15/TX20/TX25/ TX30/TX40, CENTROTEC BHS 60 CE rapid-change bit holder (205097), screwdriver SD-CE-DRIVE-UNI (200140), CENTROTEC tool chuck (492135), Systainer SYS3 ORG M 89 (204852)	576804	1	471,30	1	401003
	Ratchet set, 1/4"-CE RA-Set 36 1/4" socket set from 4.0 to 13 mm; 19 different bit inserts and 2 bit extensions; ratchet and CENTROTEC handle plus various adapters and extensions; Systainer SYS MINI (499622)	497881	1	147,80	1	301003
	Adapter, AD-D10/M14 for Festool stirrers: to mount in a drill chuck; for sanding disc with M14 thread: for mounting in drilling and boring machines; for polishing pad Ø 80: for use in cordless drills camping flange dia. 10 mm	483944	1	21,10	1	311001

* Attention: Festool products with Bluetooth® technology are not available in all countries.
For more information, please contact the official local Festool import partner.
You can find the overview regarding our products and our partners worldwide on our website www.festool.com

PU = Packaging Units
SU = Shipping Units

¹⁾ Manufacturer's recommended retail price.
Dealer prices may vary.

Drilling and screwdriving

Denomination and application		Order no.	PU	Trade price € excl. VAT per PU ¹⁾	SU	DG
CENTROTEC HSS twist drill ground; DIN 338						
		Diameter mm				
HSS D 3/33 CE/M-Set complete drill bit with CENTROTEC interface; CENTROTEC bit holder and two replacement drill bits; hexagon socket wrench	3	493421	1	11,90	1	401002
HSS D 3,5/39 CE/M-Set complete drill bit with CENTROTEC interface; CENTROTEC bit holder and two replacement drill bits; hexagon socket wrench	3,5	493422	1	12,50	1	401002
HSS D 4/43 CE/M-Set complete drill bit with CENTROTEC interface; CENTROTEC bit holder and two replacement drill bits; hexagon socket wrench	4	493423	1	13,10	1	401002
HSS D 4,5/47 CE/M-Set complete drill bit with CENTROTEC interface; CENTROTEC bit holder and two replacement drill bits; hexagon socket wrench	4,5	493424	1	14,20	1	401002
HSS D 5/52 CE/M-Set complete drill bit with CENTROTEC interface; CENTROTEC bit holder and two replacement drill bits; hexagon socket wrench	5	493425	1	14,40	1	401002
HSS D 5,5/57 CE/M-Set complete drill bit with CENTROTEC interface; CENTROTEC bit holder and two replacement drill bits; hexagon socket wrench	5,5	493426	1	14,60	1	401002
HSS D 6/57 CE/M-Set complete drill bit with CENTROTEC interface; CENTROTEC bit holder and two replacement drill bits; hexagon socket wrench	6	493427	1	15,20	1	401002
HSS D 6,5/63 CE/M-Set complete drill bit with CENTROTEC interface; CENTROTEC bit holder and two replacement drill bits; hexagon socket wrench	6,5	493428	1	15,80	1	401002
HSS D 8,0/75 CE/M-Set complete drill bit with CENTROTEC interface; CENTROTEC bit holder and replacement drill bits; hexagon socket wrench	8	495308	1	22,50	1	401002
HSS D 10,0/75 CE/M-Set complete drill bit with CENTROTEC interface; CENTROTEC bit holder and replacement drill bits; hexagon socket wrench	10	495309	1	28,00	1	401002
 HSS D3-10 CE/10 Drill bit case; with CENTROTEC interface; for machining steel and non-ferrous metals; hexagon socket wrench	3 / 3,5 / 4 / 4,5 / 5 / 5,5 / 6 / 6,5 / 8 / 10	495128	10	105,80	1	401002

HSS twist drill extra drill for CENTROTEC HSS twist drill; replacement drill bit for CENTROTEC HSS CE/M-Set twist drill bit							
	Diameter mm						
	HSS D 3/33 M/10	3	493437	10	12,10	1	401002
	HSS D 3,5/39 M/10	3,5	493438	10	12,80	1	401002
	HSS D 4/43 M/10	4	493439	10	15,70	1	401002
	HSS D 4,5/47 M/10	4,5	493440	10	17,90	1	401002
	HSS D 5/52 M/10	5	493441	10	19,60	1	401002
	HSS D 5,5/57 M/10	5,5	493442	10	21,20	1	401002
	HSS D 6/57 M/10	6	493443	10	23,00	1	401002
	HSS D 6,5/63 M/10	6,5	493444	10	25,90	1	401002
	HSS D 8,0/75 M/5	8	495310	5	27,90	1	401002
	HSS D 10,0/75 M/5	10	495311	5	41,10	1	401002

* Attention: Festool products with Bluetooth® technology are not available in all countries.
For more information, please contact the official local Festool import partner.
You can find the overview regarding our products and our partners worldwide on our website www.festool.com

PU = Packaging Units
SU = Shipping Units

¹⁾ Manufacturer's recommended retail price.
Dealer prices may vary.

Drilling and screwdriving

Denomination and application

Order no. PU Trade price
€ excl. VAT SU DG
per PU ¹⁾

Standard drill



HSS D 1-10 Sort/19

Drill bit case; without CENTROTEC interface; for machining steel and non-ferrous metals; 19 pieces

Diameter mm	Order no.	PU	Trade price € excl. VAT per PU ¹⁾	SU	DG
1 / 1,5 / 2 / 2,5 / 3 / 3,5 / 4 / 4,5 / 5 / 5,5 / 6 / 6,5 / 7 / 7,5 / 8 / 8,5 / 9 / 9,5 / 10	498981	19	64,00	1	501002

CENTROTEC masonry drills with carbide-tipped cutter

for cordless impact screwdrivers, impact drills with FastFix interface



Diameter mm	Order no.	PU	Trade price € excl. VAT per PU ¹⁾	SU	DG
DB STONE CE D4 3x for cordless impact screwdrivers, impact drills with FastFix interface; with CENTROTEC interface	4	769111	3	30,30	1 401002
DB STONE CE D5 3x for cordless impact screwdrivers, impact drills with FastFix interface; with CENTROTEC interface	5	769112	3	30,90	1 401002
DB STONE CE D6 3x for cordless impact screwdrivers, impact drills with FastFix interface; with CENTROTEC interface	6	769113	3	33,60	1 401002
DB STONE CE D8 3x for cordless impact screwdrivers, impact drills with FastFix interface; with CENTROTEC interface	8	769114	3	36,50	1 401002
DB STONE CE D10 3x for cordless impact screwdrivers, impact drills with FastFix interface; with CENTROTEC interface	10	769115	3	40,80	1 401002
DB STONE CE SET TL for SYS TL with lid compartment; for cordless impact screwdrivers, impact drills with FastFix interface; with CENTROTEC interface; for machining stone and masonry, with long-lasting carbide-tipped cutter; 6 CENTROTEC masonry drill bits: dia. 4, 5, 2 x 6, 8, 10 mm	-	769096	1	58,50	1 401002

Hammer drill bit for cordless hammer drill BHC 18

4 cutters; Bore holes in the toughest of materials such as concrete, natural stone, artificial stone, masonry



Hammer drill, SDS-Set D5-D12/7

for cordless hammer drills BHC 18 and all other hammer drills with SDS-Plus tool reception; hammer drill bit D 5 x 50 mm, 2 x hammer drill bit D 6 x 50 mm, hammer drill bit D 6 x 100 mm, hammer drill bit D 8 x 100 mm, hammer drill bit D10 x 100 mm, hammer drill bit D 12 x 100 mm

204070	7	74,50	1	501004
--------	---	-------	---	--------

CENTROTEC Forstner drill bit system







Diameter mm	Order no.	PU	Trade price € excl. VAT per PU ¹⁾	SU	DG
FB D 15-35 CE-Set with CENTROTEC interface; 5-piece; incl. conical centring bit Ø 4 mm and punch; FB D 15 CE (205752), FB D 20 CE (205753), FB D 25 CE (205754), FB D 30 CE (205755), FB D 35 CE (205756), Systainer SYS MINI 1 TL TRA with a transparent cover (203813)	15, 20, 25, 30, 35	205749	1	144,60	1 401006
FB D 15 CE with CENTROTEC interface; made from high-quality ball bearing steel; can be sharpened up to 5 times	15	205752	1	28,60	1 401006
FB D 20 CE with CENTROTEC interface; made from high-quality ball bearing steel; can be sharpened up to 5 times	20	205753	1	31,70	1 401006

* Attention: Festool products with Bluetooth® technology are not available in all countries.
For more information, please contact the official local Festool import partner.
You can find the overview regarding our products and our partners worldwide on our website www.festool.com



PU = Packaging Units
SU = Shipping Units



¹⁾ Manufacturer's recommended retail price.
Dealer prices may vary.

Drilling and screwdriving

Denomination and application		Order no.	PU	Trade price € excl. VAT per PU ¹⁾	SU	DG
	FB D 25 CE with CENTROTEC interface; made from high-quality ball bearing steel; can be sharpened up to 5 times	25	205754	1	34,80	1 401006
	FB D 30 CE with CENTROTEC interface; made from high-quality ball bearing steel; can be sharpened up to 5 times	30	205755	1	38,00	1 401006
	FB D 35 CE with CENTROTEC interface; made from high-quality ball bearing steel; can be sharpened up to 5 times	35	205756	1	41,10	1 401006
	FB-CE/ET-Set for CENTROTEC Forstner drill bit; spare parts set with conical centring point and extra-long conical centring point, conical centring drill bit (4 mm) and punch for FB D 15-35 CE-Set (item no. 205749)	-	205750	1	24,60	1 401006
	FB-CE/Er-Zobo for ZOBO drill bits; centre points (FB-CE 2.5x3.5/ZS and FB-CE 2.5x7.5/ZS), centring bit (FB-CE 3x30/ZB) and punch (for FB set D 15-35 CE ZOBO - 496390); for CENTROTEC Forstner drill bit	-	497268	1	20,60	1 401006

CENTROTEC screwdrivers

50 mm PZ bits for all Festool cordless drills with FastFix interface; for all Festool cordless drills with CENTROTEC interface						
	Size	Length mm				
	PZ 1	50	205069	2	14,60	1 401001
	PZ 2	50	205070	2	14,60	1 401001
	PZ 3	50	205072	2	14,60	1 401001

100 mm PZ bits for all Festool cordless drills with FastFix interface; for all Festool cordless drills with CENTROTEC interface						
	Size	Length mm				
	PZ 1	100	500841	2	17,70	1 401001
	PZ 2	100	500842	2	17,70	1 401001
	PZ 3	100	500843	2	17,70	1 401001

* Attention: Festool products with Bluetooth® technology are not available in all countries.
For more information, please contact the official local Festool import partner.
You can find the overview regarding our products and our partners worldwide on our website www.festool.com

PU = Packaging Units
SU = Shipping Units

¹⁾ Manufacturer's recommended retail price.
Dealer prices may vary.



Drilling and screwdriving

Denomination and application

Order no. PU Trade price
€ excl. VAT SU DG
per PU ¹⁾



50 mm PH bit

for all Festool cordless drills with FastFix interface; for all Festool cordless drills with CENTROTEC interface

	Size	Length mm					
	PH 1	50	205073	2	14,60	1	401001
	PH 2	50	205074	2	14,60	1	401001
	PH 3	50	205075	2	14,60	1	401001





100 mm PH bit

for all Festool cordless drills with FastFix interface; for all Festool cordless drills with CENTROTEC interface

	Size	Length mm					
	PH 1	100	500844	2	17,70	1	401001
	PH 2	100	500845	2	17,70	1	401001
	PH 3	100	500846	2	17,70	1	401001

50 mm TX bit

for all Festool cordless drills with FastFix interface; for all Festool cordless drills with CENTROTEC interface

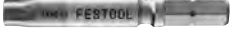



	Size	Length mm					
	TX 10	50	205076	2	14,60	1	401001
	TX 15	50	205079	2	14,60	1	401001
	TX 20	50	205080	2	14,60	1	401001
	TX 25	50	205081	2	14,60	1	401001
	TX 30	50	205082	2	14,60	1	401001
	TX 40	50	205083	2	14,60	1	401001







* Attention: Festool products with Bluetooth® technology are not available in all countries.
For more information, please contact the official local Festool import partner.
You can find the overview regarding our products and our partners worldwide on our website www.festool.com

PU = Packaging Units
SU = Shipping Units

¹⁾ Manufacturer's recommended retail price.
Dealer prices may vary.

Drilling and screwdriving

Denomination and application		Order no.	PU	Trade price € excl. VAT per PU ¹⁾	SU	DG
100 mm TX bit for all Festool cordless drills with FastFix interface; for all Festool cordless drills with CENTROTEC interface						
	Bits, TX 15-100 CE/2 with CENTROTEC interface size TX 15; length 100 mm	500847	2	17,70	1	401001
	Bits, TX 20-100 CE/2 with CENTROTEC interface size TX 20; length 100 mm	500848	2	17,70	1	401001
	Bits, TX 25-100 CE/2 with CENTROTEC interface size TX 25; length 100 mm	500849	2	17,70	1	401001
	Bits, TX 30-100 CE/2 with CENTROTEC interface size TX 30; length 100 mm	500850	2	17,70	1	401001
	Bit set, CENTROTEC BITS CE SET TL 6X for SYS TL with lid compartment; with CENTROTEC interface; in lid compartment insert; PZ 2 bit, PZ 3 bit, TX 15 bit, TX 20 bit, TX 25 bit, TX 30 bit length 100 mm	769095	6	45,60	1	401001

Bit assortment and bit holders						
	TwinBOX, BB-MIX content 10 pieces; PH 1 bit, PH 2 bit, PZ 1 bit, bit PZ 2, PZ 3 bit, SZ 0.8 x 5.5 bit, TX 15 bit, TX 20 bit, TX 25 bit, TX 30 bit length 25 mm	496936	1	21,60	1	501001
	Bit assortment, BITS + BHS 60 CE TL 24x for SYS TL with lid compartment; 24-piece; 2 x PH 1 bit, 2 x PH 2 bit, 2 x PH 3 bit, 2 x PZ 1 bit, 2 x bit PZ 2, 2 x PZ 3 bit, 2 x TX 10 bit, 2 x TX 15 bit, 2 x TX 20 bit, 2 x TX 25 bit, 2 x TX 30 bit, 2 x TX 40 bit, CENTROTEC BHS 60 CE rapid-change bit holder (205097) length 25 mm	769094	1	40,50	1	401003
	Bit holder, BHS 60 CE for all Festool cordless drills with FastFix interface; with CENTROTEC interface; magnetic CENTROTEC quick-change bit holder for supporting 25 mm standard bits length 60 mm	205097	1	34,30	1	401003
	Bit holder, BV 150 CE for all Festool cordless drills with FastFix interface; with CENTROTEC interface; extra-long	492540	1	25,80	1	401003
	Bit assortment, CENTRO Bit-Set 1 for all Festool cordless drills with CENTROTEC interface; 6-pc.; in bit check; TX 20 bit, TX 25 bit, TX 30 bit, TX 40 bit, PZ 1 bit, bit PZ 2 length 50 mm	205087	1	40,80	1	401001
	Bit assortment, DB CE 50/12-Set 1 for all Festool cordless drills with CENTROTEC interface; for SYS TL with lid compartment; 12-piece; in lid compartment insert; PH 1 bit, PH 2 bit, PH 3 bit, PZ 1 bit, bit PZ 2, PZ 3 bit, TX 10 bit, TX 15 bit, TX 20 bit, TX 25 bit, TX 30 bit, TX 40 bit length 50 mm	205089	1	84,80	1	401001

* Attention: Festool products with Bluetooth® technology are not available in all countries.
For more information, please contact the official local Festool import partner.
You can find the overview regarding our products and our partners worldwide on our website www.festool.com

PU = Packaging Units
SU = Shipping Units

¹⁾ Manufacturer's recommended retail price.
Dealer prices may vary.

Drilling and screwdriving

Denomination and application	Order no.	PU	Trade price € excl. VAT per PU ¹⁾	SU	DG
 <p>Bit assortment, SYS3 XXS CE-MX BHS 60 for all Festool cordless drills with FastFix cutting line; CENTROTEC BHS 60 CE rapid-change bit holder (205097), TX 10 bit, TX 15 bit, TX 20 bit, 2 x TX 25 bit, TX 30 bit, PZ 1 bit, 2 x bit PZ 2, PZ 3 bit, PH 1 bit, PH 2 bit, PH 3 bit, SZ 0.8 x 5.5 bit, SZ 0.6 x 4.5 bit, Systainer SYS3 XXS 33 with transparent cover dimensions with adjustable legs (L x W x H) 104 x 66 x 33 mm; length 25 mm</p>	205822	1	41,10	1	401003
 <p>Bit assortment, SYS3 XXS CE-TX BHS 60 for all Festool cordless drills with FastFix cutting line; CENTROTEC BHS 60 CE rapid-change bit holder (205097), 2 x TX 10 bit, 2 x TX 15 bit, 3 x TX 20 bit, 3 x TX 25 bit, 2 x TX 30 bit, 3 x TX 40 bit, Systainer SYS3 XXS 33 with transparent cover dimensions with adjustable legs (L x W x H) 104 x 66 x 33 mm; length 25 mm</p>	205823	1	41,10	1	401003
 <p>Bit assortment, SYS3 XXS CE-PZ BHS 60 for all Festool cordless drills with FastFix cutting line; CENTROTEC BHS 60 CE rapid-change bit holder (205097), 5 x PZ 1 bit, 7 x bit PZ 2, 3 x PZ 3 bit, Systainer SYS3 XXS 33 with transparent cover dimensions with adjustable legs (L x W x H) 104 x 66 x 33 mm; length 25 mm</p>	205824	1	41,10	1	401003
 <p>Bit assortment, SYS3 XXS CE-MX BH 60 for all Festool cordless drills with FastFix cutting line; CENTROTEC BH 60 CE Imp magnetic bit holder (498974), TX 10 bit, TX 15 bit, TX 20 bit, 2 x TX 25 bit, TX 30 bit, PZ 1 bit, 2 x bit PZ 2, PZ 3 bit, PH 1 bit, PH 2 bit, PH 3 bit, SZ 0.6 x 4.5 bit, SZ 0.8 x 5.5 bit, Systainer SYS3 XXS 33 with transparent cover dimensions with adjustable legs (L x W x H) 104 x 66 x 33 mm; length 25 mm</p>	205825	1	25,60	1	401003
CENTROTEC Impact bit holder					
 <p>Bit holder, BH 60 CE-Imp for all Festool cordless drills with FastFix interface; with CENTROTEC interface length 60 mm</p>	498974	1	13,00	1	401003
CENTROTEC adapter for plug-in bits					
 <p>Adapter, 1/4"-50 CE/KG CENTROTEC for all Festool cordless drills with FastFix interface; with CENTROTEC interface; for plug-in bits; with ball lock for manual operation length 50 mm; holder 1/4"</p>	495131	1	25,60	1	401003
 <p>Adapter, 3/8"-70 CE/KG CENTROTEC for all Festool cordless drills with FastFix interface; with CENTROTEC interface; for plug-in bits; with ball lock for manual operation length 70 mm; holder 3/8"</p>	495133	1	35,80	1	401003
CENTROTEC screwdriver					
 <p>Screwdriver, SD-CE-DRIVE-UNI for CENTROTEC tools for drilling and screwdriving</p>	200140	1	26,60	1	401003

* Attention: Festool products with Bluetooth® technology are not available in all countries.
For more information, please contact the official local Festool import partner.
You can find the overview regarding our products and our partners worldwide on our website www.festool.com

PU = Packaging Units
SU = Shipping Units

¹⁾ Manufacturer's recommended retail price.
Dealer prices may vary.

Drilling and screwdriving

Denomination and application

Order no. PU Trade price
€ excl. VAT SU DG
per PU ¹⁾

Bit range

Novadrive and CENTROTEC range



TX 10-50/BH-SORT/31x
31-piece; CENTROTEC BH 60 CE Imp magnetic bit holder (498974), 3 x TX 10 bit, 3 x TX 15 bit, 6 x TX 20 bit, 6 x TX 25 bit, 6 x TX 30 bit, 3 x TX 40 bit, 3 x TX 50 bit

Length mm	Order no.	PU	Trade price € excl. VAT per PU ¹⁾	SU	DG
25	769137	1	35,20	1	501001



BIT/BH-SORT/31x
31-piece; CENTROTEC BH 60 CE Imp magnetic bit holder (498974), LS 4,5, LS 5,5, LS 6,5, HEX 4, HEX 5, HEX 6, 2 x TX 10 bit, 2 x TX 15 bit, 2 x TX 20 bit, 2 x TX 25 bit, 2 x TX 30 bit, 2 x TX 40 bit, 2 x PH 1 bit, 2 x PH 2 bit, 2 x PH 3 bit, 2 x PZ 1 bit, 2 x bit PZ 2, 2 x PZ 3 bit

25	769138	1	35,20	1	501001
----	--------	---	-------	---	--------

Bit assortment and bit holders



Bit cassette, BT-IMP SORT1
for TID 18 cordless impact screwdriver; extra-impact-resistant bit assortment; 6-pc.; in the BitBOX; bit holder BH 52, bit PZ 2, TX 20 bit, TX 25 bit, TX 30 bit, TX 40 bit
length 25 mm

204381	1	27,40	1	501001
--------	---	-------	---	--------



Bit cassette, BT-IMP SORT3
for TID 18 cordless impact screwdriver; extra-impact-resistant bit assortment; 6-pc.; in the BitBOX; BHS 50 lockable magnetic bit holder, bit PZ 2, TX 20 bit, TX 25 bit, TX 30 bit, TX 40 bit
length 25 mm

204383	1	42,10	1	501001
--------	---	-------	---	--------



Bit cassette, BT-IMP SORT5
for TID 18 cordless impact screwdriver; extra-impact-resistant bit assortment; 6-pc.; in bit check; with 1/4" hexagonal drive; bit PZ 2, PH 2 bit, TX 20 bit, TX 25 bit, TX 30 bit, TX 40 bit
length 50 mm

204385	1	44,20	1	501001
--------	---	-------	---	--------



Socket spanner, STSL-IMP 1/4"-Set
for TID 18 cordless impact screwdriver; 3-piece; ideally suited for screwing in and unscrewing hexagon screws; socket spanner with 1/4" hexagonal holder with the following widths across flats: 1/4", 5/16" and 3/8"
length 50 mm

204388	3	45,20	1	501001
--------	---	-------	---	--------

* Attention: Festool products with Bluetooth® technology are not available in all countries.
For more information, please contact the official local Festool import partner.
You can find the overview regarding our products and our partners worldwide on our website www.festool.com

PU = Packaging Units
SU = Shipping Units

¹⁾ Manufacturer's recommended retail price.
Dealer prices may vary.

Sawing with Jigsaws

Denomination and application

Order no. PU Trade price
€ excl. VAT SU DG
per PU ¹⁾

Pendulum jigsaws

Pendulum jigsaw CARVEX PS 420

you can find the right guide rails and accessories in the "Workplace organisation" section



Pendulum jigsaw CARVEX, PS 420 EBQ-Plus

jigsaw blade set: 1 x WOOD FINE CUT S 75/2.5 and 1 x WOOD UNIVERSAL S 75/4
FSG, splinterguard, Systainer SYS3 M 137 [204841]

576175 1 401,00 1 103001

Pendulum jigsaw CARVEX, PS 420 EBQ-Set

jigsaw blade set: 1 x WOOD FINE CUT S 75/2.5 and 1 x WOOD UNIVERSAL S 75/4
FSG, splinterguard, accessories Systainer [576789], Systainer SYS3 M 137 [204841]

576176 1 656,00 1 103001

Pendulum jigsaw CARVEX PSB 420

you can find the right guide rails and accessories in the "Workplace organisation" section



Pendulum jigsaw CARVEX, PSB 420 EBQ-Plus

jigsaw blade set: 1 x WOOD FINE CUT S 75/2.5 and 1 x WOOD UNIVERSAL S 75/4
FSG, splinterguard, Systainer SYS3 M 137 [204841]

576186 1 401,00 1 103001

Cordless pendulum jigsaw CARVEX PSC 420 Li 18

you can find the right guide rails and accessories in the "Workplace organisation" section; you can find the compatible batteries and chargers available as accessories under "Battery and charging technology"



Cordless pendulum jigsaw CARVEX, PSC 420 EB-Basic

without battery pack, without charger, jigsaw blade set: 1 x WOOD FINE CUT S 75/2.5
and 1 x WOOD UNIVERSAL S 75/4 FSG, splinterguard, Systainer SYS3 M 187 [204842]

576521 1 357,00 1 103002

Cordless jigsaw CARVEX PSBC 420 Li 18

you can find the right guide rails and accessories in the "Workplace organisation" section; you can find the compatible batteries and chargers available as accessories under "Battery and charging technology"



Cordless pendulum jigsaw CARVEX, PSBC 420 EB-Basic

without battery pack, without charger, jigsaw blade set: 1 x WOOD FINE CUT S 75/2.5
and 1 x WOOD UNIVERSAL S 75/4 FSG, splinterguard, Systainer SYS3 M 187 [204842]

576530 1 357,00 1 103002

Pendulum jigsaw TRION PS 300

you can find the right guide rails and accessories in the "Workplace organisation" section



Pendulum jigsaw TRION, PS 300 EQ-Plus





jigsaw blade set: 1 x WOOD FINE CUT S 75/2.5 and 1 x WOOD UNIVERSAL S 75/4
FSG, splinterguard, Systainer SYS3 M 137 [204841]

576041 1 323,00 1 103001



Sawing with Jigsaws

Denomination and application	Order no.	PU	Trade price		
			€ excl. VAT	SU	DG
Pendulum jigsaw TRION PSB 300 you can find the right guide rails and accessories in the "Workplace organisation" section					
 Pendulum jigsaw TRION, PSB 300 EQ-Plus jigsaw blade set: 1 x WOOD FINE CUT S 75/2.5 and 1 x WOOD UNIVERSAL S 75/4 FSG, splinterguard, Systainer SYS3 M 137 [204841]	576047	1	323,00	1	103001

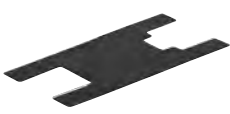
Accessories for jigsaws

CARVEX base runners					
 Base runner, LAS-PS 420 for PS(C) 400/420, PSB(C) 400/420; plastic all-round base for wood or similar materials	497297	1	11,30	1	203001
 Base runner, LAS-Soft-PS 420 for PS(C) 400/420, PSB(C) 400/420; studded base with optimum sliding properties for wood or similar materials	497298	1	11,30	1	203001
 Base runner, LAS-HGW-PS 420 for PS(C) 400/420, PSB(C) 400/420	497299	1	16,90	1	203001
 Base runner, LAS-St-PS 420 for PS(C) 400/420, PSB(C) 400/420; for all metallic materials	497300	1	16,90	1	203001
 Base runner, LAS-STF-PS 420 for PS(C) 400/420, PSB(C) 400/420	497301	1	16,90	1	203001
 Spare felt, EF-LAS-STF-PS 420 for PS(C) 400/420, PSB(C) 400/420; 5x spare felt for StickFix LAS-STF-PS 420 base runner	497444	1	9,90	1	203001

Guides and stops





 Angle table, WT-PS 420 for PS(C) 400/420, PSB(C) 400/420; for angled cuts from +45° to -45°; stepless angle adjustment	496134	1	127,30	1	203001
 base adapter, ADT-PS 420 for PS(C) 400/420, PSB(C) 400/420; for using the PS on the guide rail; for installation in the Compact Module System CMS; in conjunction with circle cutting attachment KS-PS 400	497303	1	16,00	1	203001
 Core maker, KS-PS 420 for PS(C) 400/420, PSB(C) 400/420; in conjunction with adapter table ADT-PS 400	497304	1	53,20	1	203001





* Attention: Festool products with Bluetooth® technology are not available in all countries.
 For more information, please contact the official local Festool import partner.
 You can find the overview regarding our products and our partners worldwide on our website www.festool.com

PU = Packaging Units
 SU = Shipping Units





¹⁾ Manufacturer's recommended retail price.
 Dealer prices may vary.

Sawing with Jigsaws

Denomination and application	Order no.	PU	Trade price		
			€ excl. VAT	SU	DG
			per PU ¹⁾		
 <p>Core maker, KS-PS 420 Set for PS(C) 400/420, PSB(C) 400/420; in conjunction with adapter table ADT-PS 400</p>	497443	1	69,20	1	203001
 <p>Parallel side fence, PA-PS/PSB 300 for PS 300, PSB 300, PS200, PS2 max. workpiece width 200 mm</p>	490119	1	28,90	1	203001
 <p>Core maker, KS-PS/PSB 300 for PS 300, PSB 300, PS200, PS2 circle dia. 130 - 720 mm</p>	490118	1	28,90	1	203001
 <p>Guide rail adapter, FS-PS/PSB 300 for PS 200, PS 300, PSB 300, PS 2; allows use of jigsaws with FS and FS/2 guide systems</p>	490031	1	15,80	1	203001

Other accessories					
 <p>Splinter guard, SP-PS/PSB 300/5 for PS 300, PSB 300, PS(C) 400/420, PSB(C) 400/420</p>	490120	5	7,10	1	203001
 <p>Splinter guard, SP-PS/PSB 300/20 for PS 300, PSB 300, PS(C) 400/420, PSB(C) 400/420</p>	490121	20	13,20	1	203001
 <p>Splinter guard, SP-PS/5 for PS1, PS 2, PS200</p>	483372	5	7,10	1	203001
 <p>Accessories Systainer, ZH-SYS-PS 420 for PS(C) 400/420, PSB(C) 400/420; 5 splinterguards (490120), Soft base runner (497298), Hard base runner (497299), Steel base runner (497300), StickFix baseplate (497301), angle table (496134), base adapter (497303), core maker (497304), StickFix felt, Systainer SYS3 M 112 (204840)</p>	576789	1	255,40	1	203001

WOOD jigsaw blades

Basic									
for quick cuts in wood where high precision is not required; for PS 300, PSB 300, PS 400, PSC 400, PSBC 400, PSB 400, PS 420, PSB 420, PSC 420, PSBC 420									
	Length of cutting blade mm	Pitch mm	Max. workpiece thickness mm						
 <p>S 75/4/5</p>	75	4	30	204305	5	10,20	1	503001	
 <p>S 75/4/25</p>	75	4	30	204306	25	39,60	1	503001	
 <p>S 75/4/100</p>	75	4	30	204346	100	138,30	1	503001	
 <p>S 105/4/5</p>	105	4	60	204315	5	16,20	1	503001	

* Attention: Festool products with Bluetooth® technology are not available in all countries.
For more information, please contact the official local Festool import partner.
You can find the overview regarding our products and our partners worldwide on our website www.festool.com

PU = Packaging Units
SU = Shipping Units

¹⁾ Manufacturer's recommended retail price.
Dealer prices may vary.



Sawing with Jigsaws

Denomination and application

Order no. PU Trade price
€ excl. VAT SU DG
per PU ¹⁾



Universal

conically ground teeth for clean cuts in exact angles; the universal blade for perpendicular cutting covers all relevant wood applications; ideal also in combination with the Festool guide rail; for PS 300, PSB 300, PS 400, PSC 400, PSBC 400, PSB 400, PS 420, PSB 420, PSC 420, PSBC 420

	Length of cutting blade mm	Pitch mm	Max. workpiece thickness mm						
	S 75/4 FSG/5	75	4	30	204316	5	22,10	1	503001
	S 75/4 FSG/20	75	4	30	204317	20	74,40	1	503001
	S 105/4 FSG/5	105	4	60	204327	5	29,40	1	503001
	S 105/4 FSG/20	105	4	60	204332	20	95,50	1	503001
	S 145/4 FSG/5	145	4	100	204335	5	34,20	1	503001



Straight Cut

extremely sharp Japanese teeth for highly precise cuts; for perpendicular, highly precise cuts thanks to extremely sharp Japanese teeth – the fibres are firstly scored, then cut through cleanly; for PS 300, PSB 300, PS 400, PSC 400, PSBC 400, PSB 400, PS 420, PSB 420, PSC 420, PSBC 420

	Length of cutting blade mm	Pitch mm	Max. workpiece thickness mm						
	S 75/2,8/5	75	2,8	30	204260	5	18,20	1	503001
	S 75/2,8/20	75	2,8	30	204261	20	61,50	1	503001
	S 105/2,8/5	105	2,8	60	204262	5	24,50	1	503001
	S 105/2,8/20	105	2,8	60	204263	20	81,00	1	503001
	S 145/2,8/5	145	2,8	100	204264	5	28,60	1	503001



Curves

conically ground teeth for clean cuts, to cut curves; ideal for curves – even extremely tight radii are possible; for PS 300, PSB 300, PS 400, PSC 400, PSBC 400, PSB 400, PS 420, PSB 420, PSC 420, PSBC 420

	Length of cutting blade mm	Pitch mm	Max. workpiece thickness mm						
	S 75/1,4 K/5	75	1,4	10	204267	5	12,90	1	503001
	S 75/4 K/5	75	4	30	204265	5	13,80	1	503001
	S 75/4 K/20	75	4	30	204266	20	46,10	1	503001

Fine Cut

conically ground teeth for clean cuts; for precisely cut and splinter-free surfaces; for PS 300, PSB 300, PS 400, PSC 400, PSBC 400, PSB 400, PS 420, PSB 420, PSC 420, PSBC 420

	Length of cutting blade mm	Pitch mm	Max. workpiece thickness mm						
	S 75/2,5/5	75	2,5	30	204256	5	14,60	1	503001
	S 75/2,5/25	75	2,5	30	204257	25	59,40	1	503001
	S 75/2,5/100	75	2,5	30	204258	100	190,10	1	503001
	S 75/2,5 R/5	75	2,5	30	204259	5	14,80	1	503001

* Attention: Festool products with Bluetooth® technology are not available in all countries.
For more information, please contact the official local Festool import partner.
You can find the overview regarding our products and our partners worldwide on our website www.festool.com

PU = Packaging Units
SU = Shipping Units

¹⁾ Manufacturer's recommended retail price.
Dealer prices may vary.

Sawing with Jigsaws

Denomination and application

Order no. PU Trade price
€ excl. VAT SU DG
per PU ¹⁾

PLASTICS jigsaw blades

Solid Materials

bimetal: long service and high cutting capacity; for the toughest demands such as plastic solid material and fibre-reinforced plastics; for PS 300, PSB 300, PS 400, PSC 400, PSBC 400, PSB 400, PS 420, PSB 420, PSC 420, PSBC 420

	Length of cutting blade mm	Pitch mm	Max. workpiece thickness mm					
 HS 75/3 BI/5	75	3	30	204336	5	23,80	1	503001

Profile

for plastic profiles, acrylic glass (e.g. Plexiglas®) and soft plastics; for PS 300, PSB 300, PS 400, PSC 400, PSBC 400, PSB 400, PS 420, PSB 420, PSC 420, PSBC 420

	Length of cutting blade mm	Pitch mm	Max. workpiece thickness mm					
 S 75/1,5/5	75	1,5	30	204268	5	14,60	1	503001

Laminate



for laminate and boards bonded with melamine resin (e.g. Trespa®); for PS 300, PSB 300, PS 400, PSC 400, PSBC 400, PSB 400, PS 420, PSB 420, PSC 420, PSBC 420

	Length of cutting blade mm	Pitch mm	Max. workpiece thickness mm					
 HM 90/3,3	90	3,3	30	204269	1	32,50	1	503001

METAL jigsaw blades

Steel/stainless steel

for PS 300, PSB 300, PS 400, PSC 400, PSBC 400, PSB 400, PS 420, PSB 420, PSC 420, PSBC 420; for machining aluminium, non-ferrous metals and steel

	Length of cutting blade mm	Pitch mm	Max. workpiece thickness mm					
 HS 75/1,2 BI/5	75	1,2	20	204270	5	19,90	1	503001
 HS 75/1,2 BI/20	75	1,2	20	204271	20	67,10	1	503001
 HS 105/1 BI/5	105	1	40	204272	5	24,80	1	503001

Sandwich Materials

bimetallic - extra long; as a sandwiching material; for PS 300, PSB 300, PS 400, PSC 400, PSBC 400, PSB 400, PS 420, PSB 420, PSC 420, PSBC 420

	Length of cutting blade mm	Pitch mm	Max. workpiece thickness mm					
 HS 155/1,2 BI/5	155	1,2	110	204337	5	31,60	1	503001

BUILDING MATERIALS jigsaw blades

ABRASIVE MATERIALS

carbide, cross-set teeth for abrasive materials; for gypsum and fibre cement-bonded chipboard and fibreboard; for PS 300, PSB 300, PS 400, PSC 400, PSBC 400, PSB 400, PS 420, PSB 420, PSC 420, PSBC 420

	Length of cutting blade mm	Pitch mm	Max. workpiece thickness mm					
 HM 75/4,5	75	4,5	30	204343	1	22,10	1	503001

Ceramics

tungsten carbide-sprinkled sheet, fine; for machining brickwork and ceramics; for PS 300, PSB 300, PS 400, PSC 400, PSBC 400, PSB 400, PS 420, PSB 420, PSC 420, PSBC 420

	Length of cutting blade mm	Max. workpiece thickness mm						
 R 54 G Riff	54	8	204344	1	9,80	1	503001	

* Attention: Festool products with Bluetooth® technology are not available in all countries.
For more information, please contact the official local Festool import partner.
You can find the overview regarding our products and our partners worldwide on our website www.festool.com

PU = Packaging Units
SU = Shipping Units

¹⁾ Manufacturer's recommended retail price.
Dealer prices may vary.

Sawing with Jigsaws

Denomination and application	Order no.	PU	Trade price € excl. VAT per PU ¹⁾	SU	DG
------------------------------	-----------	----	--	----	----

Insulation

for soft materials, such as insulation, foam, cardboard; for PS 300, PSB 300, PS 400, PSC 400, PSBC 400, PSB 400, PS 420, PSB 420, PSC 420, PSBC 420



	Length of cutting blade mm	Max. workpiece thickness mm					
S 155/W/3	155	110	204345	3	17,50	1	503001

Jigsaw blade range for wood

for PS 300, PSB 300, PS 400, PSC 400, PSBC 400, PSB 400, PS 420, PSB 420, PSC 420, PSBC 420



	Length of cutting blade mm	Max. workpiece thickness mm					
STS-Sort/25 W ; 5 WOOD FINE CUT saw blades (204256), 5 WOOD UNIVERSAL saw blades (204316), 5 WOOD STRAIGHT CUT saw blades (204260), 5 WOOD CURVES saw blades (204265), 5 WOOD BASIC saw blades (204305)	75	30	204275	25	62,20	1	503001

* Attention: Festool products with Bluetooth® technology are not available in all countries.
For more information, please contact the official local Festool import partner.
You can find the overview regarding our products and our partners worldwide on our website www.festool.com

PU = Packaging Units
SU = Shipping Units

¹⁾ Manufacturer's recommended retail price.
Dealer prices may vary.

Sawing with portable circular saws

Denomination and application

Order no. PU Trade price
€ excl. VAT SU DG
per PU ¹⁾

Circular saws

TSC 55 K cordless plunge-cut saw



Cordless plunge-cut saw, TSC 55 KEB-Basic

without battery pack, without charger, circular saw blade WOOD FINE CUT HW 160 x 1, 8 x 20 WD42 (205553), splinterguard, Flag window; vision panel, chip collection bag (500393), hex key, WAF 5, Systainer SYS3 M 437 (204845)

576712 1 537,00 1 102006

TS 55 F plunge-cut saw



Plunge-cut saw, TS 55 FEBQ-Plus

not compatible with the CMS module mounting CMS-TS 55 R; circular saw blade WOOD FINE CUT HW 160 x 1, 8 x 20 WD42 (205553), splinterguard, Flag window; vision panel, hex key, WAF 5, Systainer SYS3 M 337 (204844)

576703 1 508,00 1 102001



Plunge-cut saw, TS 55 FEBQ-Plus-FS

not compatible with the CMS module mounting CMS-TS 55 R; circular saw blade WOOD FINE CUT HW 160 x 1, 8 x 20 WD42 (205553), splinterguard, Flag window; vision panel, hex key, WAF 5, Systainer SYS3 M 337 (204844), guide rail FS 1400/2 (491498)

577010 1 606,00 1 102001



Plunge-cut saw, TS 55 FQ-Plus

not compatible with the CMS module mounting CMS-TS 55 R; circular saw blade WOOD UNIVERSAL HW 160 x 1, 8 x 20 W28 (205551), splinterguard, Flag window; vision panel, hex key, WAF 5, Systainer SYS3 M 337 (204844)

576711 1 441,00 1 102001

Circular saw TS 75

you can find the right guide rails and accessories in the "Workplace organisation" section



Plunge-cut saw, TS 75 EBQ-Plus

circular saw blade WOOD UNIVERSAL HW 210 x 2, 4 x 30 W36 (493198), set-back stop FS-RSP (491582), splinterguard, hex key, WAF 5, SYS 5 TL Systainer (497567)

561436 1 753,00 1 102001



Plunge-cut saw, TS 75 EBQ-Plus-FS

circular saw blade WOOD UNIVERSAL HW 210 x 2, 4 x 30 W36 (493198), set-back stop FS-RSP (491582), splinterguard, hex key, WAF 5, guide rail FS 1400/2 (491498), SYS 5 TL Systainer (497567)

561512 1 851,00 1 102001

Accessories for plunge-cut saws

Accessories for TS 55, TS 55 R, TS 55 F, TSC 55 and TSC 55 K



Parallel side fence, PA-TS 55

for TS 55, TS 55 R, TS 55 F, TSC 55, TSC 55 K; can also be used as table extension; parallel guide, guided on both sides max. workpiece width 220 mm

491469 1 49,80 1 202001



Cover, ABSA-TS 55

can also be used as false joint set; cover for improved dust extraction width of the shadow gap TS 55 15 - 46 mm

491750 1 49,30 1 202001

Sawing with portable circular saws

Denomination and application		Order no.	PU	Trade price € excl. VAT per PU ¹⁾	SU	DG
	Splinter guard, SP-TS 55/5 for TS 55, TS 75; can be used with or without guide rail; for low-splinter cuts to the right of the saw blade	491473	5	14,90	1	202001
	Splinter guard, SP-TS 55 R/5 for TS 55 R, TS 55 F, TSC 55, TSC 55 K; can be used with or without guide rail; for low-splinter cuts to the right of the saw blade	499011	5	14,90	1	202001
	Kickback stop, FS-RSP for TS 55, TS 55 R, TS 55 F, TSC 55, TSC 55 K, TS 75, HKC 55, HK 55, ATF 55, AP 55, AT 65, AP 65, AP 85; can also be used as guide stop; used as a rear and front stop position on guide rail FS/2	491582	1	17,40	1	202001
	Chip collection bag, SB-TSC for TSC 55, TSC 55 K, HKC 55; folds down for space-saving transportation; for all woods; with dust cap	500393	1	35,90	1	202001
Accessories for TS 75						
	Parallel side fence, PA-TS 75 for TS 75; parallel guide, guided on both sides; can also be used as table extension max. workpiece width 232 mm	492243	1	56,90	1	202001
	Splinter guard, SP-TS 55/5 for TS 55, TS 75; can be used with or without guide rail; for low-splinter cuts to the right of the saw blade	491473	5	14,90	1	202001

* Attention: Festool products with Bluetooth® technology are not available in all countries.
For more information, please contact the official local Festool import partner.
You can find the overview regarding our products and our partners worldwide on our website www.festool.com

PU = Packaging Units
SU = Shipping Units

¹⁾ Manufacturer's recommended retail price.
Dealer prices may vary.

Sawing with portable circular saws

Denomination and application		Order no.	PU	Trade price € excl. VAT per PU ¹⁾	SU	DG
Portable circular saws						
HKC 55 cordless portable circular saw suitable trimming rails and accessories are found in the 'Guide systems' chapter; you can find the compatible batteries and chargers available as accessories under "Battery and charging technology"						
	Cordless circular saw, HKC 55 EB-Basic without battery pack, without charger, circular saw blade WOOD STANDARD HW 160 x 1, 8 x 20 W18 (500458), hex key, WAF 5, Systainer SYS3 M 337 (204844)	576163	1	379,00	1	102007
	Cordless circular saw, HKC 55 EB-Basic-FSK 420 without battery pack, without charger, circular saw blade WOOD STANDARD HW 160 x 1, 8 x 20 W18 (500458), hex key, WAF 5, FSK 420 trimming rail (769942), Systainer SYS3 M 337 (204844)	576172	1	534,00	1	102007
HK 55 portable circular saw suitable trimming rails and accessories are found in the 'Guide systems' chapter						
	Circular saw, HK 55 EBQ-Plus circular saw blade WOOD STANDARD HW 160 x 1, 8 x 20 W18 (500458), hex key, WAF 5, Systainer SYS3 M 337 (204844)	576121	1	388,00	1	102002
	Circular saw, HK 55 EBQ-Plus-FS circular saw blade WOOD STANDARD HW 160 x 1, 8 x 20 W18 (500458), hex key, WAF 5, guide rail FS 1400/2 (491498), Systainer SYS3 M 337 (204844)	576126	1	486,00	1	102002
	Circular saw, HK 55 EBQ-Plus-FSK 420 circular saw blade WOOD STANDARD HW 160 x 1, 8 x 20 W18 (500458), hex key, WAF 5, FSK 420 trimming rail (769942), Systainer SYS3 M 337 (204844)	576131	1	564,00	1	102002
HK 85 portable circular saw suitable trimming rails and accessories are found in the 'Guide systems' chapter						
	Circular saw, HK 85 EB circular saw blade WOOD STANDARD HW 230 x 2, 5 x 30 W24 (500647), hex key, WAF 5, parallel side fence (576911)	767692	1	615,00	1	102002
	Circular saw, HK 85 EB-Plus circular saw blade WOOD STANDARD HW 230 x 2, 5 x 30 W24 (500647), parallel side fence (576911), hex key, WAF 5, Systainer SYS3 M 437 (204845)	576147	1	651,00	1	102002
	Circular saw, HK 85 EB-Plus-FS circular saw blade WOOD STANDARD HW 230 x 2, 5 x 30 W24 (500647), parallel side fence (576911), hex key, WAF 5, guide rail FS 1400/2 (491498), Systainer SYS3 M 437 (204845)	576138	1	749,00	1	102002
	Circular saw, HK 85 EB-Plus-FSK 420 circular saw blade WOOD STANDARD HW 230 x 2, 5 x 30 W24 (500647), parallel side fence (576911), hex key, WAF 5, FSK 420 trimming rail (769942), Systainer SYS3 M 437 (204845)	576142	1	800,00	1	102002

* Attention: Festool products with Bluetooth® technology are not available in all countries.
For more information, please contact the official local Festool import partner.
You can find the overview regarding our products and our partners worldwide on our website www.festool.com

PU = Packaging Units
SU = Shipping Units

¹⁾ Manufacturer's recommended retail price.
Dealer prices may vary.

Sawing with portable circular saws

Denomination and application	Order no.	PU	Trade price		
			€ excl. VAT	SU	DG

Accessories for circular saws

Trimming rails

circular saws can be easily connected to the cross cutting guide rail to form a single unit, by means of a quick fastener; the compound mitre saw system makes work easier with fast, guided and precisely-angled cross cuts; for HKC 55, HK 55, HK 85



	Cutting length mm	Angular range °	Product weight kg					
FSK 250	250	-45 – +60	0,98	769941	1	152,40	1	213001
FSK 420	420	-60 – +60	1,26	769942	1	175,80	1	213001
FSK 670	670	-60 – +60	1,63	769943	1	199,20	1	213001

Accessories for HKC 55 cordless portable circular saws



Parallel side fence, PA-HKC 55 for HKC 55, HK 55; can also be used as table extension; parallel guide, guided on both sides max. workpiece width 345 mm	576912	1	48,10	1	202001
Chip collection bag, SB-TSC for TSC 55, TSC 55 K, HKC 55; folds down for space-saving transportation; for all woods; with dust cap	500393	1	35,90	1	202001

Accessories for HK 85 portable circular saw

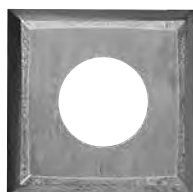

Parallel side fence, PA-HK 85 for HK 85; can also be used as table extension; parallel guide, guided on both sides max. workpiece width 403 mm	576911	1	56,30	1	202001
Parallel side fence, PA-A-HK 85 for HK 85; bilateral offset parallel stop max. workpiece width 185 mm	574670	1	91,50	1	202001
Groove unit, VN-HK85 130X16-25 for HK 85; routing transverse and longitudinal grooves; routing depth 0-35 mm and routing width adjustable by 16-25 mm; reversible blades HW-WP 14x14x2 (574671), adjustable groove cutter diameter 130 x 16-25 mm, protective cover (fixed), protective cover (moveable), Clamping flange, Counter flange, Spacer, Systainer SYS3 M 137 (204841) dust extraction connection dia. 36 mm; Product weight 0,9 kg	576803	1	550,40	1	202004
Reversible blade, HW-WP 14x14x2/12 manufactured from carbide dimensions [L x W x H] 14 x 14 x 2 mm	574671	12	68,20	1	421001

* Attention: Festool products with Bluetooth® technology are not available in all countries.
For more information, please contact the official local Festool import partner.
You can find the overview regarding our products and our partners worldwide on our website www.festool.com

PU = Packaging Units
SU = Shipping Units

¹⁾ Manufacturer's recommended retail price.
Dealer prices may vary.

Sawing with portable circular saws

Denomination and application

Order no. PU Trade price
€ excl. VAT SU DG
per PU ¹⁾

Saw blades

WOOD STANDARD

for all wooden materials, soft plastics, high-density fibreboard – coarse cut

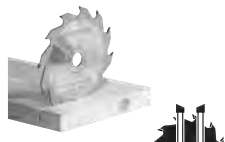

	Diameter mm	Cutting width mm	Hole dia. mm	No. of teeth	Chip angle °					
HW 160x1,8x20 W18 for HKC 55, HK 55	160	1,8	20	18	25	500458	1	40,00	1	502001
HW 160x2,2x20 W18 for TS 55, TSC 55, ATF 55, AP 55, CSP 55, CSP 56	160	2,2	20	18	25	768129	1	43,50	1	502001
HW 190x2,8x30 W16 for AT 65, AP 65	190	2,8	30	16	20	486296	1	58,60	1	502001
HW 210x2,6x30 W18 for TS 75	210	2,6	30	18	20	493197	1	66,30	1	502001
HW 230x2,5x30 W24 for HK 85; for all wooden materials, all building panels, soft plastics, coarse cut	230	2,5	30	24	20	500647	1	83,20	1	502001
HW 240x2,8x30 W22 for AP 85, AP88, AXP85	240	2,8	30	22	20	437042	1	74,80	1	502001

WOOD RIP CUT

for quicker rip cutting in solid wood with less force

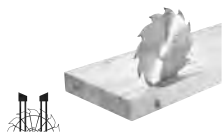

	Diameter mm	Cutting width mm	Standard blade thickness mm	Hole dia. mm	No. of teeth					
HW 160x1,8x20 PW12 for TS 55 F, TSC 55 K, HK 55 and HKC 55; for quicker rip cutting in solid wood with less force	160	1,8	1,2	20	12	205550	1	58,90	1	502001
HW 160x2,2x20 PW12 for TS 55, TSC 55, ATF 55, AP 55; for quicker rip cutting in solid wood with less force	160	2,2	-	20	12	496301	1	58,90	1	502001
HW 210x2,6x30 PW16 for TS 75; for quicker rip cutting in solid wood with less force	210	2,6	-	30	16	493196	1	84,00	1	502001
HW 230x2,5x30 PW18 for HK 85; for quicker rip cutting in solid wood with less force	230	2,5	-	30	18	500646	1	80,80	1	502001

WOOD UNIVERSAL

the all-rounder for working with all types of wood and wood materials, as well as building panels and soft plastics



	Diameter mm	Cutting width mm	Hole dia. mm	No. of teeth	Chip angle °					
HW 160x1,8x20 W28 for TS 55 F, TSC 55 K, HK 55 and HKC 55; for all wooden materials, building panels – medium cut	160	1,8	20	28	15	205551	1	67,40	1	502001
HW 160x2,2x20 W28 for TS 55, TSC 55, ATF 55, AP 55; for all wooden materials, building panels – medium cut	160	2,2	20	28	15	496302	1	67,40	1	502001
HW 190x2,8x30 W32 for AT 65, AP 65	190	2,8	30	32	15	490517	1	83,80	1	502001
HW 210x2,4x30 W36 for TS 75; for all wooden materials, building panels – medium cut	210	2,4	30	36	15	493198	1	86,60	1	502001

WOOD FINE CUT

the fine-cut saw blade for clean and splinter-free cross cuts in solid wood, laminated or veneered sheet materials and acrylic glass



	Diameter mm	Cutting width mm	Standard blade thickness mm	Hole dia. mm	No. of teeth					
HW 160x1,8x20 WD42 for TS 55 F, TSC 55 K, HK 55 and HKC 55	160	1,8	1,2	20	42	205553	1	83,90	1	502001
HW 160x2,2x20 W48 for TS 55, TSC 55, ATF 55, AP 55	160	2,2	1,6	20	48	491952	1	83,90	1	502001
HW 190x2,8x30 W48 for AT 65, AP 65	190	2,8	1,8	30	48	486297	1	100,50	1	502001

* Attention: Festool products with Bluetooth® technology are not available in all countries.
For more information, please contact the official local Festool import partner.
You can find the overview regarding our products and our partners worldwide on our website www.festool.com

PU = Packaging Units
SU = Shipping Units

¹⁾ Manufacturer's recommended retail price.
Dealer prices may vary.

Sawing with portable circular saws

Denomination and application

Order no. PU Trade price
€ excl. VAT SU DG
per PU ¹⁾



	Diameter mm	Cutting width mm	Standard blade thickness mm	Hole dia. mm	No. of teeth					
HW 210x2,4x30 W52 for TS 75	210	2,4	1,8	30	52	493199	1	117,50	1	502001
HW 230x2,5x30 W48 for HK 85	230	2,5	1,8	30	48	500648	1	113,90	1	502001

ALUMINIUM/ PLASTICS

for aluminium panels and profiles, perspex, hard and fibre-reinforced plastics, non-ferrous metals, aluminium composite panels

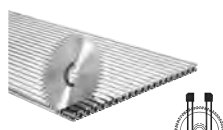

	Diameter mm	Cutting width mm	Standard blade thickness mm	Hole dia. mm	No. of teeth					
HW 160x1,8x20 F/FA52 for TS 55 F, TSC 55 K, HK 55 and HKC 55; for aluminium panels and profiles, perspex, hard and fibre-reinforced plastics, non-ferrous metals, aluminium composite panels	160	1,8	1,2	20	52	205555	1	126,50	1	502001
HW 160x2,2x20 TF52 for TS 55, TSC 55, ATF 55, AP 55; for aluminium panels and profiles, perspex, hard and fibre-reinforced plastics, non-ferrous metals, aluminium composite panels	160	2,2	1,8	20	52	496306	1	126,50	1	502002
HW 190x2,8x30 TF68 for AT 65, AP 65; for aluminium panels and profiles, perspex, hard and fibre-reinforced plastics, non-ferrous metals, aluminium composite panels	190	2,8	-	30	68	486299	1	159,30	1	502002
HW 210x2,4x30 TF72 for TS 75; for aluminium panels and profiles, perspex, hard and fibre-reinforced plastics, non-ferrous metals, aluminium composite panels	210	2,4	1,8	30	72	493201	1	189,00	1	502002
HW 230x2,5x30 TF76 for HK 85; for aluminium panels and profiles, perspex, hard and fibre-reinforced plastics, non-ferrous metals, aluminium composite panels	230	2,5	1,8	30	76	500649	1	182,20	1	502002
240x2,8x30 TF80 for AP 85, AP88, AXP85; for aluminium panels and profiles, perspex, hard and fibre-reinforced plastics, non-ferrous metals, aluminium composite panels	240	2,8	-	30	80	438638	1	200,40	1	502002

LAMINATE/ HPL

ideal for laminate and melamine-resin-bonded panels (e.g. Trespa®)



	Diameter mm	Cutting width mm	Standard blade thickness mm	Hole dia. mm	No. of teeth					
HW 160x1,8x20 TF52 for TS 55 F, TSC 55 K, HK 55 and HKC 55	160	1,8	1,2	20	52	205554	1	126,50	1	502001
HW 160x2,2x20 TF48 for TS 55, TSC 55, ATF 55, AP 55	160	2,2	1,6	20	48	496308	1	126,50	1	502002
HW 210x2,4x30 TF60 for TS 75	210	2,4	1,8	30	60	493200	1	189,00	1	502002

* Attention: Festool products with Bluetooth® technology are not available in all countries.
For more information, please contact the official local Festool import partner.
You can find the overview regarding our products and our partners worldwide on our website www.festool.com

PU = Packaging Units
SU = Shipping Units

¹⁾ Manufacturer's recommended retail price.
Dealer prices may vary.

Sawing with portable circular saws

Denomination and application

Order no. PU Trade price
€ excl. VAT SU DG
per PU ¹⁾

STEEL

for steel cable ducts, steel sheeting, steel profiles and multilayered boards

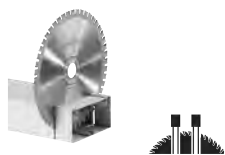

	Diameter mm	Cutting width mm	Hole dia. mm	No. of teeth	Chip angle °					
HW 210x2,2x30 F36 for TS 75	210	2,2	30	36	1	493351	1	132,00	1	502002
HW 230x2,5x30 F48 for HK 85	230	2,5	30	48	0	500651	1	127,60	1	502002
HW 240x2,6x30 F48 for AP 85	240	2,6	30	48	1	487271	1	143,50	1	502002

ABRASIVE MATERIALS

the systematic solution for work with cement-bonded and gypsum-bonded chipboard and fibreboard

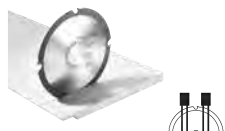
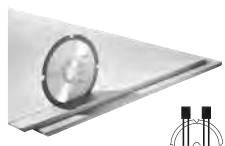

	Diameter mm	Cutting width mm	Hole dia. mm	No. of teeth	Chip angle °					
DIA 160x1,8x20 F4 for TS 55 F and TSC 55 K	160	1,8	20	4	10	205558	1	158,60	1	502001
DIA 160x2,2x20 F4 for TS 55 R and TSC 55	160	2,2	20	4	10	201910	1	171,90	1	502002

* Attention: Festool products with Bluetooth® technology are not available in all countries.
For more information, please contact the official local Festool import partner.
You can find the overview regarding our products and our partners worldwide on our website www.festool.com

PU = Packaging Units
SU = Shipping Units

¹⁾ Manufacturer's recommended retail price.
Dealer prices may vary.



Battery and charging technology

Denomination and application





Order no. PU Trade price € excl. VAT SU DG per PU ¹⁾

Battery packs

Battery pack and mains adapter

	Tensioner V	Capacity Ah	Product weight kg	Input voltage V	Rated power W					
 <p>BP 18 Li 3,1 Ergo for RTSC 400, DTSC 400, ETSC 125 cordless sanders; Lithium-ion (Li-ion) battery pack for the Festool 18 V ETSC 125, RTSC 400 and DTSC 400 cordless sanders; not compatible with all other Festool cordless tools; ergonomic, lightweight design</p>	18	3,1	0,4	–	–	202499	1	76,00	1	230002
 <p>ACA 220-240/18V Ergo for RTSC 400, DTSC 400, ETSC 125 cordless sanders; not compatible with all other Festool cordless tools; for continuous electrical operation of the RTSC 400, DTSC 400, ETSC 125 cordless sanders; ergonomic, lightweight design; plug it-power cable (4 m) [203914]</p>	18 – 20	–	0,3	220 – 240	150	202501	1	123,10	1	230003

18 V battery packs

	Tensioner V	Capacity Ah	Product weight kg						
 <p>BP 18 Li 3,1 C compact, lightweight design; Lithium-ion (Li-ion) replacement battery pack for all Festool 18 V cordless tools (except TSC 55, TSC 55 K, ETSC 125, RTSC 400, DTSC 400)</p>	18	3,1	0,4	201789	1	76,00	1	230002	
 <p>BP 18 Li 4,0 HPC-AS with AIRSTREAM function; lithium-ion (Li-ion) replacement battery pack for all Festool 18 V cordless tools (except CXS, TXS, ETSC 125, RTSC 400, DTSC 400)</p>	18	4	0,6	205033	1		1		
 <p>BP 18 Li 5,2 AS with AIRSTREAM function; lithium-ion (Li-ion) replacement battery pack for all Festool 18 V cordless tools (except CXS, TXS, ETSC 125, RTSC 400, DTSC 400)</p>	18	5,2	0,7	200181	1	103,50	1	230002	
 <p>BP 18 Li 6,2 AS with AIRSTREAM function; lithium-ion (Li-ion) replacement battery pack for all Festool 18 V cordless tools (except CXS, TXS, ETSC 125, RTSC 400, DTSC 400)</p>	18	6,2	0,7	201774	1	135,20	2	230002	

15 V battery packs



	Tensioner V	Capacity Ah	Product weight kg					
 <p>BPC 15 5,2 Ah-Li Ion lithium-ion spare battery for cordless drills T 15+3, C 15 Li, TI 15 IMPACT and PSC/PSBC 420</p>	14,4	5,2	0,58	500434	1	95,80	1	230002

* Attention: Festool products with Bluetooth® technology are not available in all countries. For more information, please contact the official local Festool import partner. You can find the overview regarding our products and our partners worldwide on our website www.festool.com

PU = Packaging Units
SU = Shipping Units

¹⁾ Manufacturer's recommended retail price. Dealer prices may vary.



Battery and charging technology

Denomination and application	Order no.	PU	Trade price			SU	DG
			€	excl. VAT	per PU ¹⁾		
10.8 V/12 V battery packs							
							
BP-XS 2.6 Ah Li-Ion for CXS and TXS cordless drills; Lithium-ion (Li-ion) battery pack for Festool CXS and TXS cordless drills	10,8	2,6	0,2	500184	1	67,30	1 230002
							
BPC 12 Li 4,2 Ah lithium-ion spare battery for cordless drills T 12+3 and C 12 Li	10,8	4,2	0,49	205238	1	93,30	1 230002
BPC 12 Li 1,5 Ah lithium-ion spare battery for cordless drills T 12+3 and C 12 Li	10,8	1,5	0,31	498336	1	82,90	1 230002



NiMh battery packs

12 V NiMh battery packs							
	Tensioner V	Capacity Ah	Product weight kg				
							
BP 12 T 3,0 Ah replacement battery for the TDD 12, TDD 14,4 cordless drills; Nickel-metal-hydride battery pack	12	3	0,69	489731	1	151,90	1 230002

Accessories for battery packs

Accessories for BPC battery packs							
							
GR-BPC 15/18 for all BPC 15/18 battery packs; for battery packs from the BPC series; replacement frame for battery packs on DRC 18/4, PDC 18/4, BHC 18, DWC 18-4500, DWC 18-2500; rubberised frame for battery packs				769240	1	6,50	1 201007
							
GR-BPC 15/18 for all BPC 15/18 battery packs; for battery packs from the BPC series; replacement frame for battery packs on DRC 18/4, PDC 18/4, BHC 18, DWC 18-4500, DWC 18-2500; rubberised frame for battery packs				769240	1	6,50	1 201007

Chargers

Rapid chargers							
							
Rapid charger, SCA 8 for all Li-ion battery packs (except for CXS/TXS); with AIRSTREAM function; Lithium-ion (Li-ion) replacement charger for all 10.8 - 18 V battery packs charging current 8 A; input voltage 220 - 240 V; Product weight 1,1 kg				200178	1	92,90	1 230001
							
Rapid charger, TCL 6 for all Li-ion battery packs (except for CXS/TXS); Lithium-ion (Li-ion) replacement charger for all 10.8 - 18 V battery packs charging current 6 A; input voltage 220 - 240 V; Product weight 0,8 kg				201135	1	60,10	1 230001

* Attention: Festool products with Bluetooth® technology are not available in all countries.
For more information, please contact the official local Festool import partner.
You can find the overview regarding our products and our partners worldwide on our website www.festool.com

PU = Packaging Units
SU = Shipping Units

¹⁾ Manufacturer's recommended retail price.
Dealer prices may vary.

Battery and charging technology

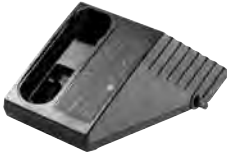
Denomination and application	Order no.	PU	Trade price € excl. VAT per PU ¹⁾	SU	DG
 <p>Chargers</p> <p>Charger, MXC for CXS and TXS cordless drills; for BP-XS battery packs charging current 2,8 A; input voltage 220 - 240 V</p>	497495	1	60,00	1	230001

* Attention: Festool products with Bluetooth® technology are not available in all countries.
For more information, please contact the official local Festool import partner.
You can find the overview regarding our products and our partners worldwide on our website www.festool.com

PU = Packaging Units
SU = Shipping Units

¹⁾ Manufacturer's recommended retail price.
Dealer prices may vary.

Cutting with insulation saws

Denomination and application

Order no. PU Trade price € excl. VAT SU DG per PU ¹⁾

Cordless insulating-material saw

Cordless insulating-material saw ISC 240

you can find the right guide rails and accessories in the "Workplace organisation" section; you can find the compatible batteries and chargers available as accessories under "Battery and charging technology"



Cordless insulating-material saw, ISC 240 EB-Basic

without battery pack, without charger, SG-240/W-ISC serrated cutting set (575411), adapter table (204160), guide rail slide, Systainer SYS3 M 237 (204843)

576571	1	422,00	1	126002
--------	---	--------	---	--------

Cordless insulating-material saw, ISC 240 HPC 4,0 EBI-Plus-XL-FS

2 x BP 18 Li 4.0 HPC-ASI battery pack (205034), rapid charger TCL 6 (201135), SG-240/W-ISC serrated cutting set (575411), adapter table (204160), guide rail slide, angle stop (575413), guide rail FS 1400/2 (491498), Systainer SYS3 M 237 (204843)

576572	1	953,00	1	126002
--------	---	--------	---	--------

Accessories for cordless insulating-material saws

Accessories for ISC 240



Cutting set, SG-240/G-ISC

for ISC 240 EB; cutting set with cross-set saw blade cutting length 240 mm

575409	1	60,30	1	226002
--------	---	-------	---	--------



Cutting set, SG-350/G-ISC

for ISC 240 EB; cutting set with cross-set saw blade cutting length 350 mm

575410	1	82,20	1	226002
--------	---	-------	---	--------



Cutting set, SG-240/W-ISC

for ISC 240 EB; cutting set with serrated saw blade; for flexible mineral fibre insulating materials and natural insulating materials cutting length 240 mm

575411	1	82,20	1	226002
--------	---	-------	---	--------



Cutting set, SG-350/W-ISC

for ISC 240 EB; cutting set with serrated saw blade; for flexible mineral fibre insulating materials and natural insulating materials cutting length 350 mm

575412	1	103,90	1	226002
--------	---	--------	---	--------



Saw blade, DSB 240/G

for ISC 240 EB; replacement saw blade for SG-240/G-ISC cross-set cutting set cutting length 240 mm; saw blade material HCS

575414	1	22,00	1	426002
--------	---	-------	---	--------



Saw blade, DSB 350/G

for ISC 240 EB; replacement saw blade for SG-350/G-ISC cross-set cutting set cutting length 350 mm; saw blade material HCS

575415	1	32,90	1	426002
--------	---	-------	---	--------



Saw blade, DSB 240/W

for ISC 240 EB; Replacement saw blade (movable) for SG-240/W-ISC serrated cutting set cutting length 240 mm; saw blade material HCS

575416	1	22,00	1	426002
--------	---	-------	---	--------



Saw blade, DSB 350/W

for ISC 240 EB; Replacement saw blade (movable) for SG-350/W-ISC serrated cutting set cutting length 350 mm; saw blade material HCS

575417	1	32,90	1	426002
--------	---	-------	---	--------



Angle stop, FS-WA-ISC

mounting on the guide rail without the use of tools; stop ruler, adjustable stop max. workpiece width 900 mm; angular range -47° - +47°

575413	1	164,30	1	226002
--------	---	--------	---	--------

Sword saws

Sword saw UNIVERS SSU 200

Sword saw UNIVERS, SSU 200 EB-Plus

universal saw chain SC 3/8" 91 U-39E (769101), chain oil 250 ml, 7.5 m power cord, protective cover, SYS 5 TL Systainer (497567)

575980	1	1.063,00	1	126001
--------	---	----------	---	--------

Sword saw UNIVERS, SSU 200 EB-Plus-FS

universal saw chain SC 3/8" 91 U-39E (769101), chain oil 250 ml, 7.5 m power cord, guide rail FS 800/2 (491499), protective cover, SYS 5 TL Systainer (497567)

575982	1	1.129,00	1	126001
--------	---	----------	---	--------



* Attention: Festool products with Bluetooth® technology are not available in all countries.

For more information, please contact the official local Festool import partner. You can find the overview regarding our products and our partners worldwide on our website www.festool.com

PU = Packaging Units
SU = Shipping Units

¹⁾ Manufacturer's recommended retail price. Dealer prices may vary.

Cutting with insulation saws

Denomination and application	Order no.	PU	Trade price		
			€ excl. VAT	SU	DG
Sword saw IS 330					
 <p>Sword saw, IS 330 EB Iso SC 3/8"-90 I-57E chainsaw chain (769088), Iso Hard SC 3/8"-91 IH-57E chainsaw chain (769090), chain oil 250 ml, 7.5 m power cord, protective cover</p>	575979	1	1.215,00	1	126001
	575983	1	1.305,00	1	126001

Sword saw accessories

Accessories for sword saw UNIVERS SSU 200						
	<p>Blade, GB 10"-SSU 200 for SSU 200, SSP 200 cutting width 9 mm</p>	769066	1	61,20	1	426001
	<p>Chainsaw chain, SC 3/8"-91 I-39E for SSU 200, SSP 200; saw chain ISO; chain pitch 3/8"</p>	769100	1	66,60	1	426001
	<p>Chainsaw chain, SC 3/8"-91 U-39E for SSU 200, SSP 200; saw chain Uni; chain pitch 3/8"</p>	769101	1	32,80	1	426001
	<p>Chainsaw chain, SC 3/8"-91 F-39E for SSU 200, SSP 200; saw chain fine; chain pitch 3/8"</p>	769102	1	41,10	1	426001
	<p>Chainsaw chain, SC 3/8"-91 L-39E for SSU 200, SSP 200; chain pitch 3/8"</p>	769103	1	41,10	1	426001

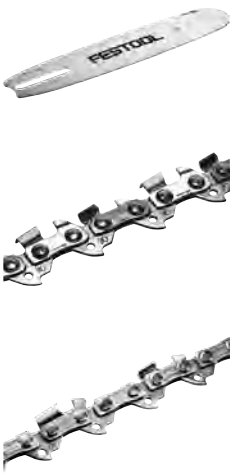

Accessories for sword saw IS 330						
	<p>Blade, GB 13"-IS 330 for IS 330, ISP 330 cutting width 9 mm</p>	769089	1	91,70	1	426001
	<p>Chainsaw chain, SC 3/8"-91 I-57E for IS 330, ISP 330; saw chain ISO; chain pitch 3/8"</p>	769088	1	99,70	1	426001
	<p>Chainsaw chain, SC 3/8"-91 IH-57E for IS 330, ISP 330; saw chain ISO Hard; chain pitch 3/8"; for extremely pressure-resistant insulating materials</p>	769090	1	99,70	1	426001

* Attention: Festool products with Bluetooth® technology are not available in all countries.
For more information, please contact the official local Festool import partner.
You can find the overview regarding our products and our partners worldwide on our website www.festool.com

PU = Packaging Units
SU = Shipping Units

¹⁾ Manufacturer's recommended retail price.
Dealer prices may vary.

Cutting with insulation saws







Denomination and application	Order no.	PU	Trade price € excl. VAT per PU ¹⁾	SU	DG
Accessories for sword saw UNIVERS SSU 200 + IS 330					
 <p>Parallel side fence, PA-SSU 200 for SSU 200, IS 330, SSP 200, ISP 330; parallel guide, guided on both sides</p>	769098	1	43,80	1	226001
 <p>Parallel side fence, PA-A SSU 200 for SSU 200, IS 330, SSP 200, ISP 330; bilateral offset parallel stop</p>	769099	1	76,00	1	226001
 <p>Chain lubrication oil, CO 1 L for SSU 200, IS 330, SSP 200, ISP 330, CCP 380; volume 1 litre in carton</p>	769038	1	10,50	1	516002

* Attention: Festool products with Bluetooth® technology are not available in all countries.
For more information, please contact the official local Festool import partner.
You can find the overview regarding our products and our partners worldwide on our website www.festool.com

PU = Packaging Units
SU = Shipping Units

¹⁾ Manufacturer's recommended retail price.
Dealer prices may vary.

Semi-stationary sawing

Denomination and application		Order no.	PU	Trade price € excl. VAT per PU ¹⁾	SU	DG
Table saw						
TKS 80 table saw						
	Table saw, TKS 80 EBS circular saw blade WOOD UNIVERSAL HW 254 x 2, 4 x 30 W40 (575975), KT-TKS 80 cartridge (575851), angle stop, dust extraction set (488292), workpiece holder, hex key, WAF 5, 1 open ended spanner, size 50, 1 open ended spanner, size 23	575781	1	1.886,00	1	105010
	Table saw, TKS 80 EBS-Set circular saw blade WOOD UNIVERSAL HW 254 x 2, 4 x 30 W40 (575975), KT-TKS 80 cartridge (575851), angle stop, dust extraction set (488292), extension table VB TKS 80 (575840), guide extension VL TKS 80 (575825), LA TKS 80 stopper (575826), sliding table ST TKS 80 (575827), workpiece holder, hex key, WAF 5, 1 open ended spanner, size 50, 1 open ended spanner, size 23	575828	1	3.134,00	1	105010
Accessories for table saw						
Accessories for TKS 80 table saw						
	Cartridge, KT-TKS 80 for TKS 80; replacement cartridge; contains the central element of the TKS 80: SawStop AIM technology	575851	1	92,60	1	405001
	Guide extension, VL TKS 80 for TKS 80; for safe and precise sawing to length; extends the support area by 580 mm; easy and quick to assemble and dismantle; with adjustable dimension scale	575825	1	273,70	1	205013
	Extension table, VB TKS 80 for TKS 80; for safe and precise width sawing; extends the support area by 411 mm; maximum cutting width with 680 mm rip cut; with adjustable dimension scale; easy and quick to assemble and dismantle	575840	1	384,90	1	205013
	Stopper, LA TKS 80 for TKS 80; with fine adjuster for precise rip cuts; front operating lever; clamp for secure mounting on the bench-mounted circular saw; moveable stop profile	575826	1	270,00	1	205013
	Sliding table, ST TKS 80 for TKS 80; for cross-cutting with a cutting width up to 920 mm; with four plastic rollers to ensure that the sliding table moves smoothly; can be installed in two positions for a large work area	575827	1	319,50	1	205013

* Attention: Festool products with Bluetooth® technology are not available in all countries.
 For more information, please contact the official local Festool import partner.
 You can find the overview regarding our products and our partners worldwide on our website www.festool.com

PU = Packaging Units
 SU = Shipping Units

¹⁾ Manufacturer's recommended retail price.
 Dealer prices may vary.

Semi-stationary sawing

Denomination and application

Order no. PU Trade price
€ excl. VAT SU DG
per PU ¹⁾

Saw blades for table saw

WOOD RIP CUT

panther saw blade for making rip cuts in solid wood

	Diameter mm	Cutting width mm	Hole dia. mm	No. of teeth	Chip angle °					
HW 254x2,4x30 PW24 for TKS 80	254	2,4	30	24	20	575974	1	77,50	1	505002

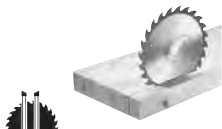

WOOD UNIVERSAL

universal saw blade for machining solid wood cross cuts, blockboard, plywood, multiplex/multilayered wood, raw chipboard, MDF (medium-density fibreboard) and HDF (high-density fibreboard)

	Diameter mm	Cutting width mm	Hole dia. mm	No. of teeth	Chip angle °					
HW 254x2,4x30 W40 for TKS 80	254	2,4	30	40	15	575975	1	119,50	1	505002

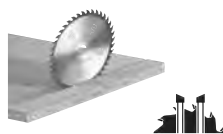

WOOD FINE CUT

fine tooth saw blade for machining veneered boards, parquet, hard plastics, hard PVC, solid wood cross cuts, blockboard, plywood, multiplex/multilayered wood, acrylic glass and MDF (medium-density fibreboard)

	Diameter mm	Cutting width mm	Hole dia. mm	No. of teeth	Chip angle °					
HW 254x2,4x30 W60 for TKS 80	254	2,4	30	60	10	575976	1	150,70	1	505002



Laminate saw blade

special saw blade for machining coated panels, laminate panels, melamine hard panels, mineral materials and phenolic-resin-bonded fibres and fabrics

	Diameter mm	Cutting width mm	Hole dia. mm	No. of teeth	Chip angle °					
HW 254x2,4x30 TF80 L for TKS 80	254	2,4	30	80	4	575977	1	171,50	1	505002



Aluminium saw blade

for machining aluminium panels and profiles, non-ferrous metals, hard and fibre-reinforced plastics

	Diameter mm	Cutting width mm	Hole dia. mm	No. of teeth	Chip angle °					
HW 254x2,4x30 TF80 A for TKS 80	254	2,4	30	80	-5	575978	1	171,50	1	505002









* Attention: Festool products with Bluetooth® technology are not available in all countries.
For more information, please contact the official local Festool import partner.
You can find the overview regarding our products and our partners worldwide on our website www.festool.com

PU = Packaging Units
SU = Shipping Units

¹⁾ Manufacturer's recommended retail price.
Dealer prices may vary.

Semi-stationary sawing

Denomination and application		Order no.	PU	Trade price € excl. VAT per PU ¹⁾	SU	DG
Trimming saws						
Trimming saw PRECISIO CS 50						
	Trimming saw PRECISIO, CS 50 EBG-FLR circular saw blade WOOD UNIVERSAL HW 190 x 2, 6 FF W32 (492048), angle stop (574797), 3 x splinterguard, workpiece holder, accessories holder, hex key, WAF 6	574770	1	1.149,00	1	105002
	Trimming saw PRECISIO, CS 50 EBG circular saw blade WOOD UNIVERSAL HW 190 x 2, 6 FF W32 (492048), angle stop (574797), foldaway legs (575671), 3 x splinterguard, dust extraction set (488292), workpiece holder, accessories holder, support with transport roller, hex key, WAF 6	574765	1	1.377,00	1	105002
	Trimming saw PRECISIO, CS 50 EBG-Set circular saw blade WOOD UNIVERSAL HW 190 x 2, 6 FF W32 (492048), angle stop (574797), ripping-cut fence (574796), Sliding table (492100), extension table (492092), extension table (492090), foldaway legs (575671), 3 x splinterguard, dust extraction set (488292), workpiece holder, accessories holder, support with transport roller, hex key, WAF 6	574772	1	2.470,00	1	105002

Trimming saw PRECISIO CS 70						
	Trimming saw PRECISIO, CS 70 EBG note: with stabilising electronics without air filters; circular saw blade WOOD UNIVERSAL HW 225 x 2, 6 x 30 W32 (488288), angle stop (574797), workpiece holder, accessories holder, support with transport roller, hex key, WAF 6	574778	1	1.601,00	1	105002
	Trimming saw PRECISIO, CS 70 EBG circular saw blade WOOD UNIVERSAL HW 225 x 2, 6 x 30 W32 (488288), 3 x splinterguard, angle stop (574797), dust extraction set (488292), workpiece holder, accessories holder, support with transport roller, Air filter, hex key, WAF 6	574776	1	1.893,00	1	105002
	Trimming saw PRECISIO, CS 70 EBG-Set circular saw blade WOOD UNIVERSAL HW 225 x 2, 6 x 30 W32 (488288), sliding table CS 70 ST 650 (490312), extension table CS 70 VB (488060), extension table CS 70 VL (488061), ripping-cut fence (488062), angle stop (574797), 3 x splinterguard, dust extraction set (488292), workpiece holder, accessories holder, support with transport roller, Air filter, hex key, WAF 6	574782	1	3.338,00	1	105002

Accessories for trimming saw

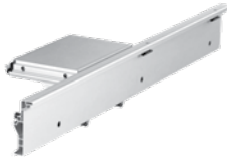





Table extensions and other accessories						
	Sliding table, ST for CS 50, CMS-GE; for MFT 3-VL max. working width for trimming cuts 830 mm	492100	1	328,80	1	205003



* Attention: Festool products with Bluetooth® technology are not available in all countries.
For more information, please contact the official local Festool import partner.
You can find the overview regarding our products and our partners worldwide on our website www.festool.com

PU = Packaging Units
SU = Shipping Units

¹⁾ Manufacturer's recommended retail price.
Dealer prices may vary.

Semi-stationary sawing

Denomination and application		Order no.	PU	Trade price € excl. VAT per PU ¹⁾	SU	DG
	Extension table, VL for CS 50, CMS-GE; simple fitting, folds away; for safe support of long workpieces when sawing to width; enlarges the support surface by 405 mm dimensions length x width 375 x 454 mm	492092	1	230,30	1	205003
	Extension table, VB for CS 50; with adjustable dimension scale; easy and quick to assemble and dismantle; for safe and precise width sawing; extends the support area by 410 mm max. working width longitudinal 610 mm; dimensions length x width 664 x 438 mm	492090	1	295,90	1	205003
	Support, AF for CS 50, CMS-GE; support for both side use; supports workpieces while cutting; enlarges the support surface by 300 mm dimensions length x width 662 x 390 mm	492242	1	98,80	1	205003
	Sliding table, CS 70 ST for CS 70; easy and quick to assemble and dismantle; 2 x supporting legs, stop ruler with additional clamp max. working width for trimming cuts 920 mm	488059	1	924,00	1	205003
	Sliding table, CS 70 ST 650 for CS 70; for sawing boards; easy and quick to assemble and dismantle max. working width for trimming cuts 650 mm	490312	1	488,40	1	205003
	Extension table, CS 70 VB for CS 70; with adjustable dimension scale; easy and quick to assemble and dismantle; for safe and precise width sawing; extends the support area by 411 mm max. working width longitudinal 680 mm; dimensions length x width 773 x 435 mm	488060	1	396,20	1	205003
	Extension table, CS 70 VL for CS 70; simple fitting, folds away; for safe support of long workpieces when sawing to width; extends the support area by 580 mm dimensions length x width 525 x 522 mm	488061	1	282,00	1	205003



Stops						
	Stopper, LA-CS 50/CMS for CS 50, CMS-GE; with fine adjuster for precise rip cuts; front operating lever; clamp for secure mounting on the bench-mounted circular saw; moveable stop profile	574796	1	238,50	1	205003
	Stopper, CS 70 LA for CS 70, MFT/3-VL	488062	1	278,00	1	205003

* Attention: Festool products with Bluetooth® technology are not available in all countries.
For more information, please contact the official local Festool import partner.
You can find the overview regarding our products and our partners worldwide on our website www.festool.com



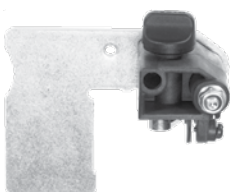

PU = Packaging Units
SU = Shipping Units

¹⁾ Manufacturer's recommended retail price.
Dealer prices may vary.

Semi-stationary sawing

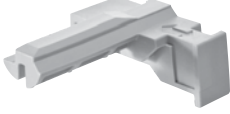
Denomination and application	Order no.	PU	Trade price € excl. VAT per PU ¹⁾	SU	DG
 <p>Angle stop, WA for CS 70, CS 50, CMS-GE; for work requiring 2 stops</p>	574797	1	160,40	1	205003
 <p>Trimming attachment, CS 70 KA for CS 70 and CS 50; removable, with support, bearing surface, tape measure and adjustable stop; simple extraction and rolling out of measuring tape thanks to telescopic mechanism length 1200 - 2050 mm</p>	488063	1	342,40	1	205003
 <p>Adjustable stop, KA-AR for CS 50, CS 70; for KA-KS 120-L trimming attachment and KA-KS 120-R trimming attachment; for positioning workpieces on trimming attachment CS 70 KA, Basis KA 100/200 and KA-KS L/R</p>	488560	1	35,70	1	205003
<p>Adjustable stop, WA-AR for CS 50, CS 70; to stop workpieces on trimming attachment CS 70 WA, CS 50 WA and Basis WRA 500</p>	491712	1	35,70	1	205003

Accessories



 <p>Roller stand, RB for all semi-stationary devices (CS/KS/CMS); may be used with the CS 50, CS 70, CB 120, Basis Plus System, CMS-GE, multifunction table; to use longer workpieces for longitudinal sections and cross sections and cutting and grinding work height adjustable 630 - 1000 mm</p>	488711	1	175,50	1	205003
 <p>Splinter guard, CS 50 SP/10 for CS 50; for splinter-free cut edges on both sides</p>	492241	10	19,30	1	205003
 <p>Splinter guard, CS 70 SP /10 for CS 70; for splinter-free cut edges on both sides</p>	490340	10	19,30	1	205003
 <p>Transport rollers, CS 70 TR for CS 70</p>	488064	1	100,50	1	205003
 <p>Dust extraction set, CS 70 AB for CT/CTM; comprising: dust extraction hose D27x2.0 m, dust extraction hose D36x1.0 m, Y terminal; can be used with Basic, CMS, CS 50, CS 70 and TKS 80 diameter 27/36 mm</p>	488292	1	100,00	1	205003
 <p>Adapter hose, AD-D 36/CS50/CS70/CMS for CS 50, CS 70, CMS; 0.5 m hose D36 with two rotating adapters and connection coupling, anti-static D50/D50 VM-AS; for Y-shaped connection (452898) in conjunction with CTL MINI/MIDI and CTM MIDI diameter 36 mm; length 0,5 m</p>	499196	1	37,60	1	309001

* Attention: Festool products with Bluetooth® technology are not available in all countries.
For more information, please contact the official local Festool import partner.
You can find the overview regarding our products and our partners worldwide on our website www.festool.com



PU = Packaging Units
SU = Shipping Units



¹⁾ Manufacturer's recommended retail price.
Dealer prices may vary.

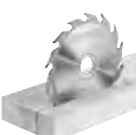

Semi-stationary sawing



Denomination and application	Order no.	PU	Trade price		
			€ excl. VAT	SU	DG
 <p>Foldaway legs, CS 50 KB for CS 50; foldaway legs for the extension of the CS 50 FLR version</p>	575671	1	197,50	1	205003
 <p>Saw blade holder, SGA for CS 50, CMS-GE; for safe and space-saving storage of up to 4 saw blades (max. Ø 190 mm) and up to 3 splinterguards (not included in contents)</p>	492228	1	48,20	1	205007

Saw blades for trimming saw

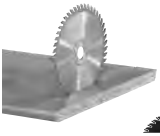
WOOD RIP CUT for quicker rip cutting in solid wood with less force										
	Diameter mm	Cutting width mm	Hole dia. mm	No. of teeth	Chip angle °					
 <p>HW 190x2,6 FF PW16 for CS 50</p>	190	2,6	FF	16	28	492049	1	75,50	1	505002
 <p>HW 225x2,6x30 PW18 for CS 70</p>	225	2,6	30	18	28	496303	1	84,40	1	505002

Universal saw blade for all wooden materials, building panels – medium cut										
	Diameter mm	Cutting width mm	Hole dia. mm	No. of teeth	Chip angle °					
 <p>HW 190x2,6 FF W32 for CS 50</p>	190	2,6	FF	32	10	492048	1	84,10	1	505002
 <p>HW 225x2,6x30 W32 for CS 70</p>	225	2,6	30	32	20	488288	1	84,40	1	505002

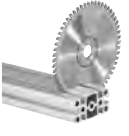
Fine tooth saw blade for veneered and coated panels, solid wood, MDF – fine cut										
	Diameter mm	Cutting width mm	Hole dia. mm	No. of teeth	Chip angle °					
 <p>HW 190x2,4 FF W48 for CS 50</p>	190	2,4	FF	48	8	492050	1	100,70	1	505002
 <p>HW 225x2,6x30 W48 for CS 70</p>	225	2,6	30	48	10	488289	1	118,00	1	505002

Special saw blade for aluminium panels and profiles, perspex, hard and fibre-reinforced plastics, non-ferrous metals, aluminium composite panels										
	Diameter mm	Cutting width mm	Hole dia. mm	No. of teeth	Chip angle °					
 <p>HW 190x2,6 FF TF58 for CS 50; For aluminium panels and profiles as well as for hard and fibre-reinforced plastic</p>	190	2,6	FF	58	-5	492051	1	159,90	1	505003
 <p>HW 225x2,6x30 TF68 for CS 70</p>	225	2,6	30	68	-5	488291	1	185,40	1	505003

* Attention: Festool products with Bluetooth® technology are not available in all countries.
For more information, please contact the official local Festool import partner.
You can find the overview regarding our products and our partners worldwide on our website www.festool.com

PU = Packaging Units
SU = Shipping Units

¹⁾ Manufacturer's recommended retail price.
Dealer prices may vary.

Semi-stationary sawing

Denomination and application	Order no.	PU	Trade price		SU	DG
			€ excl. VAT	per PU ¹⁾		

Special saw blade

for laminate, coated panels and mineral materials



	Diameter mm	Cutting width mm	Hole dia. mm	No. of teeth	Chip angle °					
HW 190x2,6 FF TF54 for CS 50	190	2,6	FF	54	4	492052	1	159,90	1	505003
HW 225x2,6x30 TF64 for CS 70	225	2,6	30	64	4	489459	1	185,40	1	505003

Cordless sliding compound mitre saw

Sliding compound mitre saw KAPEX KS 60

Sliding compound mitre saw KAPEX, KS 60 E

circular saw blade WOOD UNIVERSAL HW 216 x 2, 3 x 30 W36 (500124), fastening clamp FSZ 120, hex key, WAF 6



561683	1	720,00	1	105009
--------	---	--------	---	--------

Sliding compound mitre saw KAPEX, KS 60 E-Set

circular saw blade WOOD UNIVERSAL HW 216 x 2, 3 x 30 W36 (500124), fastening clamp FSZ 120, LED spotlight (500120), Bevel (200127), elevation (500121), hex key, WAF 6



561728	1	834,00	1	105009
--------	---	--------	---	--------

Sliding compound mitre saw KAPEX, KS 60 E-UG-Set

circular saw blade WOOD UNIVERSAL HW 216 x 2, 3 x 30 W36 (500124), fastening clamp FSZ 120, LED spotlight (500120), Bevel (200127), elevation (500121), under-frame (200129), hex key, WAF 6



574788	1	1.160,00	1	105009
--------	---	----------	---	--------

Sliding compound mitre saw KAPEX, KS 60 E-UG-Set/XL

circular saw blade WOOD UNIVERSAL HW 216 x 2, 3 x 30 W36 (500124), fastening clamp FSZ 120, LED spotlight (500120), Bevel (200127), elevation (500121), under-frame (200129), KA-UG-KS 60 R/L trimming stop (201909), hex key, WAF 6



574789	1	1.713,00	1	105009
--------	---	----------	---	--------

KAPEX KS 120 R sliding compound mitre saw

Sliding compound mitre saw KAPEX, KS 120 REB

circular saw blade WOOD UNIVERSAL HW 260 x 2, 5 x 30 W60 (494604), Bevel (200127), workpiece clamp (494391), hex key, WAF 6





575302	1	1.395,00	1	105008
--------	---	----------	---	--------

* Attention: Festool products with Bluetooth® technology are not available in all countries.
For more information, please contact the official local Festool import partner.
You can find the overview regarding our products and our partners worldwide on our website www.festool.com

PU = Packaging Units
SU = Shipping Units

¹⁾ Manufacturer's recommended retail price.
Dealer prices may vary.





Semi-stationary sawing

Denomination and application	Order no.	PU	Trade price		
			€ excl. VAT	SU	DG
 <p>Sliding compound mitre saw KAPEX, KS 120 REB-Set-UG (KA-UG-R, KA-UG-L and UG-KAPEX incl. in the contents); circular saw blade WOOD UNIVERSAL HW 260 x 2, 5 x 30 W60 (494604), Bevel (200127), workpiece clamp (494391), underframe (497351), trimming attachment KA-UG-R/L (497514), adjustable stop (488560), telescopic slide-out scale, fold-out pedestal, hex key, WAF 6</p>	575313	1	2.274,00	1	105008
 <p>Sliding compound mitre saw KAPEX, KS 120 REB-Set-MFT circular saw blade WOOD UNIVERSAL HW 260 x 2, 5 x 30 W60 (494604), Bevel (200127), workpiece clamp (494391), multifunction table MFT KAPEX (495465), AB-KA-UG crown stop (203356), trimming attachment KA-UG-R/L (497514), clamping set (494693), adjustable stop (488560), telescopic slide-out scale, fold-out pedestal, hex key, WAF 6</p>	576663	1	2.399,00	1	105008





Accessories for sliding compound mitre saw

Accessories for KS 60 sliding compound mitre saw/KSC 60 cordless sliding compound mitre saw					
 <p>Bevel, SM-KS for KS 60, KS 120; bevel for transferring angles to the circular cross-cut saw; for interior and exterior angles; dissecting angle is generated automatically</p>	200127	1	88,00	1	205009
 <p>Underframe, UG-KA-KS 60 Set for KS 60; simple folding in for transport; underframe (200129), KA-UG-KS 60 R/L trimming stop (201909) work height 900 mm; Product weight 21 kg</p>	202055	1	878,60	1	205009
 <p>Underframe, UG-KS 60 for KS 60 work height 900 mm; Product weight 13 kg</p>	200129	1	395,80	1	205009
 <p>Spot lighting, SL-KS 60 for KS 60; LED spot lighting for precisely highlighting the cutting line and optimal visibility of the scribe mark; for retrofitting the KS 60; items already included with the KS 60 set variants</p>	500120	1	55,20	1	205009
 <p>Trimming attachment, KA-UG-KS 60-R for KS 60; for use in conjunction with the Festool UG-KAPEX KS 60 base frame; adjustable stop, telescopic slide-out scale, fold-out pedestal, measurement scale length of extension arm (without telescope) 1480 mm; max. meas. length 2400 mm; Product weight 4,6 kg</p>	201908	1	241,70	1	205009
 <p>Trimming attachment, KA-UG-KS 60-L for KS 60; for use in conjunction with the Festool UG-KAPEX KS 60 base frame; adjustable stop, telescopic slide-out scale, fold-out pedestal, measurement scale length of extension arm (without telescope) 1480 mm; max. meas. length 2400 mm; Product weight 4,6 kg</p>	201907	1	241,70	1	205009

Semi-stationary sawing

Denomination and application	Order no.	PU	Trade price € excl. VAT per PU ¹⁾	SU	DG
 <p>Trimming attachment, KA-UG-KS 60-R/L for KS 60; for use in conjunction with the Festool UG-KAPEX KS 60 base frame; comprising KA-UG-L trimming attachment and KA-UG-R trimming attachment; adjustable stop, telescopic slide-out scale, fold-out pedestal, measurement scale length of extension arm (without telescope) 1480 mm; max. meas. length 2400 mm</p>	201909	1	482,80	1	205009
 <p>Adapter plate, UG-AD-KS 60 for KS 60; adapter plate and saw blade holder for attaching the KS 60 to the UG-KAPEX KS 60 base frame</p>	202056	1	118,20	1	205009
 <p>Increase, A-SYS-KS 60 for KS 60; intermediate bases for elevating the KS 60 to the height of a Systainer SYS 1 T-LOC and Classic; Table height = Systainer: Long workpieces can be comfortably supported on the floor while working; for retrofitting the KS 60; items already included with the KS 60 set variants</p>	500121	1	32,70	1	205009
 <p>Clamping kit, SZ-KS for KS 120, KS 88, KS 60; for tightening the KS on the multifunction table</p>	494693	1	15,20	1	205009

Accessories for KS 88 and KS 120 sliding compound mitre saws



 <p>Bevel, SM-KS for KS 60, KS 120; bevel for transferring angles to the circular cross-cut saw; for interior and exterior angles; dissecting angle is generated automatically</p>	200127	1	88,00	1	205009
 <p>Underframe, UG-KA-KS 120-Set for KS 120, KS 88; simple folding in for transport; transport rollers, underframe (497351), trimming attachment KA-UG-R/L (497514) work height 900 mm; Product weight 21 kg</p>	497354	1	878,60	1	205009
 <p>Underframe, UG-KAPEX KS 120 for KS 120, KS 88; transport rollers work height 900 mm; Product weight 10,1 kg</p>	497351	1	395,80	1	205009
 <p>Trimming attachment, KA-UG-KS 120-R for KS 120, KS 88; for use in conjunction with the Festool UG-KAPEX KS 120 base frame; measurement scale, adjustable stop, telescopic slide-out scale, fold-out pedestal length of extension arm (without telescope) 1480 mm; max. meas. length 2400 mm; Product weight 4,6 kg</p>	497352	1	241,70	1	205009
 <p>Trimming attachment, KA-UG-KS 120-L for KS 120, KS 88; for use in conjunction with the Festool UG-KAPEX KS 120 base frame; measurement scale, adjustable stop, telescopic slide-out scale, fold-out pedestal length of extension arm (without telescope) 1480 mm; max. meas. length 2400 mm; Product weight 4,6 kg</p>	497353	1	241,70	1	205009

* Attention: Festool products with Bluetooth® technology are not available in all countries.
For more information, please contact the official local Festool import partner.
You can find the overview regarding our products and our partners worldwide on our website www.festool.com

PU = Packaging Units
SU = Shipping Units

¹⁾ Manufacturer's recommended retail price.
Dealer prices may vary.

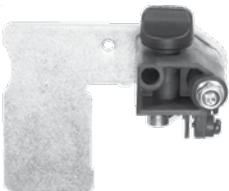
Semi-stationary sawing

Denomination and application	Order no.	PU	Trade price € excl. VAT per PU ¹⁾	SU	DG
 <p>Trimming attachment, KA-UG-KS 120-R/L for KS 120, KS 88; comprising KA-UG-L trimming attachment and KA-UG-R trimming attachment; for use in conjunction with the Festool UG-KAPEX KS 120 base frame; measurement scale, adjustable stop, telescopic slide-out scale, fold-out pedestal length of extension arm (without telescope) 1480 mm; max. meas. length 2400 mm</p>	497514	1	482,80	1	205009
 <p>Clamping kit, SZ-KS for KS 120, KS 88, KS 60; for tightening the KS on the multifunction table</p>	494693	1	15,20	1	205009
 <p>Terminal, KL-KS 120 for KS 120, KS 88; can be used on the left or right; workpiece clamp for securing workpieces; included in the contents of the KS 120 maximum height of workpiece 120 mm</p>	494391	1	53,20	1	205009
 <p>Crown stop, AB-KS 120 for KS 120, KS 88; stop for positioning crown mouldings at an angle; also used for securing the table extension KA-KS; only compatible with KA-KS; crown moulding stop with table widener</p>	494369	1	72,80	1	205009
 <p>Crown stop, AB-KA-UG/2 for KS 120, KS 88, KS 60; stop for positioning crown mouldings at an angle; only compatible with KA-UG trimming attachment underframe</p>	203356	2	101,70	1	205009
 <p>Adjustable stop, KA-AR for CS 50, CS 70; for KA-KS 120-L trimming attachment and KA-KS 120-R trimming attachment; for positioning workpieces on trimming attachment CS 70 KA, Basis KA 100/200 and KA-KS L/R</p>	488560	1	35,70	1	205003
 <p>Adjustable stop, MFT/3-AR for the MFT 3; for securing workpieces on the angle stop; Can be folded away</p>	495542	1	22,40	1	205005

* Attention: Festool products with Bluetooth® technology are not available in all countries.
For more information, please contact the official local Festool import partner.
You can find the overview regarding our products and our partners worldwide on our website www.festool.com

PU = Packaging Units
SU = Shipping Units

¹⁾ Manufacturer's recommended retail price.
Dealer prices may vary.

Semi-stationary sawing

Denomination and application

Order no. PU Trade price
€ excl. VAT SU DG
per PU ¹⁾

Saw blades for sliding compound mitre saw

WOOD UNIVERSAL

for all wooden materials, building panels – medium cut



HW 260x2,5x30 W60
for KS 120, KS 88

	Diameter mm	Cutting width mm	Hole dia. mm	No. of teeth	Chip angle °					
	260	2,5	30	60	-5	494604	1	160,50	1	505002
	216	2,3	30	36	-5	500124	1	100,20	1	505002



HW 216x2,3x30 W36
for KS 60

WOOD FINE CUT



HW 260x2,5x30 W80
for KS 120, KS 88

	Diameter mm	Cutting width mm	Hole dia. mm	No. of teeth	Chip angle °					
	260	2,5	30	80	-5	494605	1	192,60	1	505002
	216	2,3	30	60	-5	500125	1	146,20	1	505002

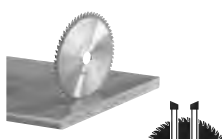

HW 216x2,3x30 W60
for KS 60

LAMINATE/ HPL

for aluminium panels and profiles, perspex, hard and fibre-reinforced plastics, non-ferrous metals, aluminium composite panels

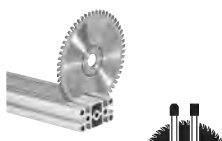

HW 260x2,4x30 TF68
for KS 120, KS 88

	Diameter mm	Cutting width mm	Hole dia. mm	No. of teeth	Chip angle °					
	260	2,4	30	68	0	494607	1	188,50	1	505003
	216	2,3	30	64	0	500122	1	178,80	1	505003



HW 216x2,3x30 TF64
for KS 60

* Attention: Festool products with Bluetooth® technology are not available in all countries.
For more information, please contact the official local Festool import partner.
You can find the overview regarding our products and our partners worldwide on our website www.festool.com

PU = Packaging Units
SU = Shipping Units

¹⁾ Manufacturer's recommended retail price.
Dealer prices may vary.

Semi-stationary sawing

Denomination and application

Order no. PU Trade price
€ excl. VAT SU DG
per PU ¹⁾

LAMINATE/ HPL

for laminate, coated panels and mineral materials

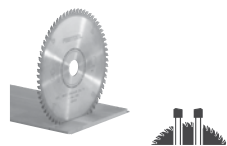

HW 260x2,5x30 WZ/FA64
for KS 120, KS 88

	Diameter mm	Cutting width mm	Hole dia. mm	No. of teeth	Chip angle °					
	260	2,5	30	64	-5	494606	1	188,50	1	505003
	216	2,3	30	60	-5	500123	1	178,80	1	505003



HW 216x2,3x30 WZ/FA60
for KS 60

Compound mitre saw SYM

Compound mitre saw SYMMETRIC SYM 70



Compound mitre saw SYMMETRIC, SYM 70 RE

circular saw blade WOOD FINE CUT HW 216 x 2,3 x 30 W48 (491050), precision adjustable square (491053), elevation of EH-SYS-SYM 70 (203425), workpiece clamp, hex key, WAF 5

574927	1	864,00	1	105003
--------	---	--------	---	--------

Accessories for mitre saw

Accessories for compound mitre saw SYM 70



Precision adjustable square, SM-SYM 70
for SYM 70

491053	1	31,80	1	205004
--------	---	-------	---	--------



Table top insert, TE-SYM 70
for SYM 70

491054	3	22,30	1	205004
--------	---	-------	---	--------

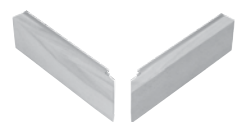

Additional stop, ZA-SYM 70 E
for SYM 70

491886	2	49,40	1	205004
--------	---	-------	---	--------



Increase, EH-SYS-SYM 70

for SYM 70; already included in scope of delivery for SYM 70 RE (for retrofitting to the SYM 70 E)

203425	1	31,20	1	205004
--------	---	-------	---	--------

ALUMINIUM/ PLASTICS

for aluminium panels and profiles, perspex, hard and fibre-reinforced plastics, non-ferrous metals, aluminium composite panels



HW 216x2,3x30 W60
for SYM 70

	Diameter mm	Cutting width mm	Hole dia. mm	No. of teeth	Chip angle °					
	216	2,3	30	60	-5	491051	1	178,80	1	505002

Semi-stationary sawing

Denomination and application	Order no.	PU	Trade price € excl. VAT per PU ¹⁾	SU	DG
------------------------------	-----------	----	--	----	----

WOOD FINE CUT

for veneered and coated panels, solid wood, MDF – fine cut

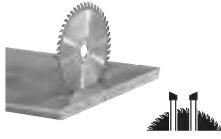

	Diameter mm	Cutting width mm	Hole dia. mm	No. of teeth	Chip angle °					
HW 216x2,3x30 W48 for SYM 70	216	2,3	30	48	-5	491050	1	122,10	1	505002

* Attention: Festool products with Bluetooth® technology are not available in all countries.
For more information, please contact the official local Festool import partner.
You can find the overview regarding our products and our partners worldwide on our website www.festool.com

PU = Packaging Units
SU = Shipping Units

¹⁾ Manufacturer's recommended retail price.
Dealer prices may vary.

Semi-stationary work

Denomination and application

Order no. PU Trade price
€ excl. VAT SU DG
per PU ¹⁾

STM 1800 work bench



STM 1800 work bench

Mobile saw table and work bench, STM 1800

height-adjustable work bench for machining large panels and cutting them to size; contact surface can be extended using extension tubes; castor wheels and wooden supports partially pre-installed (items included); fitted wooden coverings, four extension pipes with wooden coverings

205183	1	1.259,50	1	205014
--------	---	----------	---	--------

Accessories for STM 1800 work bench

FS-WA angle stop

Angle stop, FS-WA/90°

for FS/2; for precise and reproducible 90° cutting of sheet materials without any readjustments; completely self-aligning and precise thanks to milled aluminium stop; easily and quickly connect with the guide rail using the quick-clamping lever



205229	1	141,80	1	213002
--------	---	--------	---	--------

Angle stop, FS-WA

for FS/2; can be extended with FS-WA-VL guide extension; positioning bolt angular range -60 - +60 °



577040	1	156,10	1	213002
--------	---	--------	---	--------

Guide extension, FS-WA-VL

for the FS-WA angle stop; used to extend the angle stop; cuts made to size with repeat accuracy using the guide extension with a scale and an adjustable stop; stable connection to the angle stop using the connecting pieces; adjustable stop, connecting pieces



577041	1	51,00	1	213002
--------	---	-------	---	--------

Accessories for CMS

Accessories for CMS

Extension table, VB-CMS

for CMS-GE; with adjustable dimension scale; extends the support area by 410 mm cutting width 570 mm; dimensions length x width 664 x 438 mm



493822	1	296,10	1	205003
--------	---	--------	---	--------

Extension table, VL

for CS 50, CMS-GE; simple fitting, folds away; for safe support of long workpieces when sawing to width; enlarges the support surface by 405 mm dimensions length x width 375 x 454 mm



492092	1	230,30	1	205003
--------	---	--------	---	--------

Sliding table, ST

for CS 50, CMS-GE; for MFT 3-VL max. working width for trimming cuts 830 mm

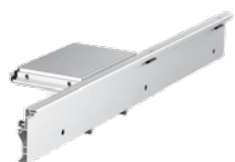

492100	1	328,80	1	205003
--------	---	--------	---	--------

Saw blade holder, SGA

for CS 50, CMS-GE; for safe and space-saving storage of up to 4 saw blades (max. Ø 190 mm) and up to 3 splinterguards (not included in contents)



492228	1	48,20	1	205007
--------	---	-------	---	--------

Support, AF

for CS 50, CMS-GE; support for both side use; supports workpieces while cutting; enlarges the support surface by 300 mm dimensions length x width 662 x 390 mm







492242	1	98,80	1	205003
--------	---	-------	---	--------

* Attention: Festool products with Bluetooth® technology are not available in all countries.
For more information, please contact the official local Festool import partner.
You can find the overview regarding our products and our partners worldwide on our website www.festool.com

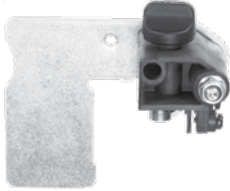

PU = Packaging Units
SU = Shipping Units

¹⁾ Manufacturer's recommended retail price.
Dealer prices may vary.

Semi-stationary work

Denomination and application	Order no.	PU	Trade price € excl. VAT per PU ¹⁾	SU	DG
 <p>Roller stand, RB for all semi-stationary devices (CS/KS/CMS); may be used with the CS 50, CS 70, CB 120, Basis Plus System, CMS-GE, multifunction table; to use longer workpieces for longitudinal sections and cross sections and cutting and grinding work height adjustable 630 - 1000 mm</p>	488711	1	175,50	1	205003
 <p>Adjustable stop, WA-AR for CS 50, CS 70; to stop workpieces on trimming attachment CS 70 WA, CS 50 WA and Basis WRA 500</p>	491712	1	35,70	1	205003
 <p>Dust extraction set, CS 70 AB for CT/CTM; comprising: dust extraction hose D27x2.0 m, dust extraction hose D36x1.0 m, Y terminal; can be used with Basic, CMS, CS 50, CS 70 and TKS 80 diameter 27/36 mm</p>	488292	1	100,00	1	205003
 <p>Adapter hose, AD-D 36/CS50/CS70/CMS for CS 50, CS 70, CMS; 0.5 m hose D36 with two rotating adapters and connection coupling, anti-static D50/D50 VM-AS; for Y-shaped connection (452898) in conjunction with CTL MINI/MIDI and CTM MIDI diameter 36 mm; length 0,5 m</p>	499196	1	37,60	1	309001
 <p>Extension table, VB-CMS/CS 50 for CS 50, CMS-GE; dummy plate, foldaway legs dimensions length x width 664 x 480 mm</p>	495531	1	440,00	1	205003

Accessories for CMS-OF, base 5 A and base 6

 <p>Rebating head, FK D 50x30 for OF 1010, OF 1400, OF 2200; for use with cutter spindles diameter 50 mm; NL 30 mm</p>	489284	1	126,90	1	205002
 <p>Cutter spindle, ASL20/OF1010 for OF 1010; required for holding the FK D rebating head 50 x 30 (489284)</p>	489285	1	40,90	1	205008
<p>Cutter spindle, ASL20/OF1400-OF2200 for OF 1400, OF 2200; required for holding the FK D rebating head 50 x 30 (489284)</p>	490131	1	48,40	1	205008

* Attention: Festool products with Bluetooth® technology are not available in all countries.
For more information, please contact the official local Festool import partner.
You can find the overview regarding our products and our partners worldwide on our website www.festool.com

PU = Packaging Units
SU = Shipping Units

¹⁾ Manufacturer's recommended retail price.
Dealer prices may vary.

Semi-stationary work

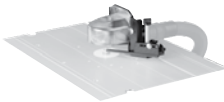
Denomination and application	Order no.	PU	Trade price		
			€ excl. VAT	SU	DG
 <p>Reversible blade, WP 30x12x1,5 for rebating head</p>	489286	2	25,90	1	205008
 <p>Guard, BF-OF-CMS for CMS-OF 1010; for CMS-OF 1400/OF 2000/OF 2200; guard and extractor hood dust extraction connection dia. 27/36 mm</p>	494643	1	60,70	1	205003

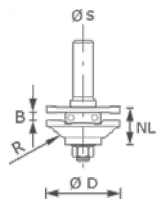
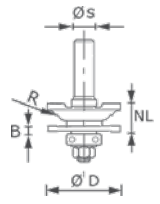
Accessories for Basis 6										
	D mm	NL mm	B mm	R mm	s mm					
 <p>HW S8 D46 x D12-FD for routing counterprofiles for cassette frames</p>	46	20	4	22	8	490643	1	192,30	1	506001
 <p>HW S8 D46 x D12-NT for profiling cassette frames with grooves for cassette fillings</p>	46	20	4	22	8	490645	1	192,30	1	506001

Abrasives for CMB and CMS-BS 120

CMB 120 and CMS-BS 120 sanding belts										
sanding belt Saphir CMB 120; for CMB 120										
	Dimensions mm	Grit								
	820 x 120	P50	488081	10	86,20	1	508004			
	820 x 120	P80	488082	10	86,20	1	508004			
	820 x 120	P100	488083	10	76,60	1	508004			
	820 x 120	P120	488084	10	76,60	1	508004			
	820 x 120	P150	488085	10	76,60	1	508004			
	820 x 120	P180	488086	10	76,60	1	508004			



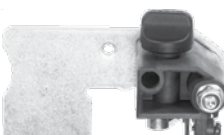
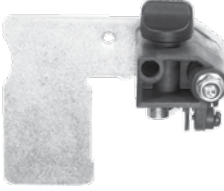

Accessories for Basis Plus

Sliding table and fences					
 <p>Connecting piece, VS for attachment of FST660/85 or MFT 800 to Basis Plus; for connecting several MFT 3</p>	484455	1	14,80	1	205002
 <p>Adjustable stop, KA-AR for CS 50, CS 70; for KA-KS 120-L trimming attachment and KA-KS 120-R trimming attachment; for positioning workpieces on trimming attachment CS 70 KA, Basis KA 100/200 and KA-KS L/R</p>	488560	1	35,70	1	205003
 <p>Adjustable stop, WA-AR for CS 50, CS 70; to stop workpieces on trimming attachment CS 70 WA, CS 50 WA and Basis WRA 500</p>	491712	1	35,70	1	205003



Semi-stationary work

Denomination and application	Order no.	PU	Trade price		
			€ excl. VAT	SU	DG
 <p>Other accessories</p> <p>Dust extraction set, CS 70 AB for CT/CTM; comprising: dust extraction hose D27x2.0 m, dust extraction hose D36x1.0 m, Y terminal; can be used with Basic, CMS, CS 50, CS 70 and TKS 80 diameter 27/36 mm</p>	488292	1	100,00	1	205003

Multifunction table

 <p>Multifunction table MFT 3</p> <p>Multifunction table, MFT/3 table with perforated top and foldaway legs, swivel unit, support unit, angle stop, adjustable stop [495542], guide rail FS 1080/2 [491504], deflector FS-AW [489022], additional clamp [495541]</p>	495315	1	743,10	1	205010
 <p>Multifunction table, MFT/3 Basic table with perforated top and foldaway legs</p>	500608	1	583,90	1	205010
 <p>Multifunction table, MFT KAPEX used as a base frame for the KAPEX; clamping kit SZ-KS required for fixing; table with perforated top and foldaway legs</p>	495465	1	403,70	1	205010
 <p>Multifunction table, MFT/3 Conturo-AP for KA 65; table with perforated top and foldaway legs; for using the edge bander CONTURO KA 65 as a bench-mounted machine; adapter plate AP-KA 65 [500175], cross brace QT-MFT/3 [495502]</p>	500869	1	950,80	1	205010

Accessories for multifunction table

Accessories					
 <p>Cross brace, MFT 3-QT for additional MFT 3 stability diameter 20 mm; length 675 mm</p>	495502	2	99,30	1	205005
 <p>Additional clamp, MFT/3-ZK for securing the stop rail to the V-groove</p>	495541	1	36,90	1	205005

* Attention: Festool products with Bluetooth® technology are not available in all countries.
For more information, please contact the official local Festool import partner.
You can find the overview regarding our products and our partners worldwide on our website www.festool.com

PU = Packaging Units
SU = Shipping Units

¹⁾ Manufacturer's recommended retail price.
Dealer prices may vary.

Semi-stationary work

Denomination and application	Order no.	PU	Trade price € excl. VAT per PU ¹⁾	SU	DG
 <p>Fixed clamps, MFT-SP for MFT; for safe and precise securing of the workpiece (sawing, sanding, routing, drilling, etc.)</p>	488030	2	101,80	1	205005
 <p>Lever clamp, MFT-HZ 80 for MW 1000 mobile workshop and MFT 3; It is possible to secure different materials up to a height of 80 mm dimensions (L x W x H) 130 x 40 x 155 mm; maximum height of workpiece 80 mm</p>	577132	1	41,10	1	205005
 <p>Lever clamp, FS-HZ 160 for FS/2, MFT; solid steel version clamping width 160 mm</p>	491594	1	55,80	1	213002
 <p>Fastening clamp, FSZ 120 for FS/2, MFT; solid steel version clamping width 120 mm</p>	489570	2	40,60	1	213002
 <p>Fastening clamp, FSZ 300 for FS/2, MFT; solid steel version clamping width 300 mm</p>	489571	2	50,00	1	213002
 <p>Base, TSB/1-MW 1000 for MW 1000 mobile workshop and MFT 3; extended work space; aluminium profile and perforated top allow for use of many existing accessories work height 900 mm; dimensions (L x W x H) 1045 x 500 x 74 mm; Product weight 12,2 kg</p>	203457	1	290,00	1	205005
 <p>Connecting piece, VS for attachment of FST660/85 or MFT 800 to Basis Plus; for connecting several MFT 3</p>	484455	1	14,80	1	205002
 <p>Adapter, VAC SYS AD MFT 3 for VAC SYS SE 1, VAC SYS SE 2; for connecting the VAC SYS clamping unit with the MFT 3</p>	494977	1	247,10	1	225001
 <p>Adjustable stop, MFT/3-AR for the MFT 3; for securing workpieces on the angle stop; Can be folded away</p>	495542	1	22,40	1	205005

* Attention: Festool products with Bluetooth® technology are not available in all countries.
For more information, please contact the official local Festool import partner.
You can find the overview regarding our products and our partners worldwide on our website www.festool.com

PU = Packaging Units
SU = Shipping Units

¹⁾ Manufacturer's recommended retail price.
Dealer prices may vary.

Denomination and application	Order no.	PU	Trade price		
			€ excl. VAT	SU	DG

Cordless oscillator

VECTURO OSC 18 cordless oscillator

you can find the compatible batteries and chargers available as accessories under "Battery and charging technology"



Cordless oscillator VECTURO, OSC 18 E-Basic without battery pack, without charger, USB 78/32/Bi/OSC universal saw blade, Systainer SYS3 M 187 [204842]	576591	1	322,00	1	128002
Cordless oscillator VECTURO, OSC 18 E-Basic-Set without battery pack, without charger, OSC-AV dust extraction device [203256], OSC-AH positioning aid [203254], OSC-TA depth stop [203255], OSC-A adapter, USB 78/32/Bi/OSC universal saw blade, USB 50/35/Bi/OSC universal saw blade, HSB 100/Bi/OSC wood saw blade [203334], Systainer SYS3 M 187 [204842]	576592	1	549,00	1	128002

Accessories for OSC 18

Accessories for OSC 18 oscillator



Depth stop, OSC-TA for OSC 18; enables plunge cuts with a defined depth; contains two inserts: A rotating depth stop for plunge cuts and a sliding shoe for long, straight cuts; includes an adapter for fitting accessories without tools; working angle can be flexibly adjusted; OSC-A adapter max. plunge depth, depth stop 56 mm; max. plunge depth, sliding shoe 20 mm; notch scale on depth adjuster 1,5 mm; Product weight 0,2 kg	203255	1	53,60	1	228001
--	--------	---	-------	---	--------



Positioning aid, OSC-AH for OSC 18; makes it possible to create precisely guided plunge cuts; equipped with a depth stop and an extractor connector for removing dust when sawing; includes an adapter for fitting accessories without tools; can be used with offset saw blades; OSC-A adapter max. plunge depth with position guide 42 mm; Product weight 0.485 kg	203254	1	128,70	1	228001
---	--------	---	--------	---	--------



Dust extraction device, OSC-AV for OSC 18; makes it possible to saw with minimal dust generation; provides an optimal view of the workpiece; machine can be safely guided with both hands; includes an adapter for fitting accessories without tools; OSC-A adapter max. dust extraction device plunge depth 47 mm; Product weight 0.125 kg	203256	1	53,60	1	228001
--	--------	---	-------	---	--------



Oscillator accessories set, OSC-AH/TA/AV-Set for OSC 18; makes it possible to create precisely guided plunge cuts, saw with minimal dust generation.; includes an adapter for fitting accessories without tools; OSC-AH positioning aid [203254], OSC-TA depth stop [203255], OSC-AV dust extraction device [203256], OSC-A adapter max. plunge depth, depth stop 56 mm; max. plunge depth, sliding shoe 20 mm; max. plunge depth with position guide 42 mm; notch scale on depth adjuster 1,5 mm; Product weight 0,64 kg	203258	1	171,40	1	228001
--	--------	---	--------	---	--------

Oscillators

Denomination and application

Order no. PU Trade price
€ excl. VAT SU DG
per PU ¹⁾

Saw blades for OSC 18

Wood saw blade

for processing wooden materials; Japan toothing (except HSB 100/HCS)

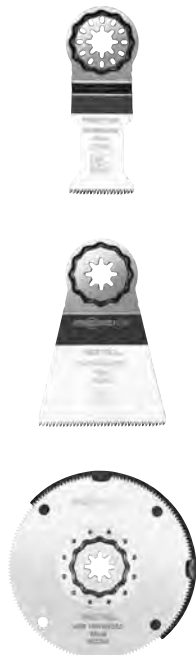



HSB 50/35/J/OSC/5
for OSC 18

Length mm	Width mm	Order no.	PU	Trade price € excl. VAT per PU ¹⁾	SU	DG
50	35	203333	5	75,00	1	528001
50	65	203332	5	80,30	1	528001
-	-	203334	1	74,30	1	528001

HSB 50/65/J/OSC/5
for OSC 18

HSB 100/Bi/OSC
for OSC 18

Oscillators

Denomination and application	Order no.	PU	Trade price € excl. VAT per PU ¹⁾	SU	DG
Special saw blade special saw blades for applications such as removing window glass, silicone or adhesive					
 <p>SSB 32/OSC for OSC 18</p>	204410	1	65,40	1	528001
 <p>SSP 52/OSC for OSC 18</p>	204412	1	24,80	1	528001
 <p>SSB 90/OSC/DIA for OSC 18; extremely durable and robust thanks to premium-quality diamond coating</p>	204414	1	96,50	1	528001
<hr/>					
 <p>SSB 32/OSC for OSC 18</p>	204410	1	65,40	1	528001
 <p>SSP 52/OSC for OSC 18</p>	204412	1	24,80	1	528001
 <p>SSB 90/OSC/DIA for OSC 18; extremely durable and robust thanks to premium-quality diamond coating</p>	204414	1	96,50	1	528001

* Attention: Festool products with Bluetooth® technology are not available in all countries.
For more information, please contact the official local Festool import partner.
You can find the overview regarding our products and our partners worldwide on our website www.festool.com

PU = Packaging Units
SU = Shipping Units





¹⁾ Manufacturer's recommended retail price.
Dealer prices may vary.

Denomination and application

Order no. PU Trade price
€ excl. VAT SU DG
per PU ¹⁾



WOOD UNIVERSAL

bimetal; for processing a range of different materials

	Length mm	Width mm					
 <p>USB 78/32/Bi/OSC/5 for OSC 18; made of high-grade bimetal</p>	78	32	203337	5	74,00	1	528001
 <p>USB 50/35/Bi/OSC/5 for OSC 18; made of high-grade bimetal</p>	50	35	203338	5	75,00	1	528001
 <p>USB 78/42/Bi/OSC/5 for OSC 18; made of high-grade bimetal</p>	78	42	203336	5	78,20	1	528001
 <p>USB 50/65/Bi/OSC/5 for OSC 18; made of high-grade bimetal</p>	50	65	203960	5	80,30	1	528001

Accessories for OS 400

Accessories for OS 400 oscillator

 <p>Depth stop set, OS-TA Set for OS 400; enables plunge cuts with a defined depth; contains two inserts: A rotating depth stop for plunge cuts and a sliding shoe for long, straight cuts; includes an adapter for fitting accessories without tools; working angle can be flexibly adjusted; adapter for mounting positioning aid and depth stop without tools max. plunge depth, depth stop 56 mm; max. plunge depth, sliding shoe 20 mm; notch scale on depth adjuster 1,5 mm; Product weight 0,1 kg</p>	500160	1	59,00	1	228001
 <p>Positioning aid set, OS-AH Set for OS 400; adapter for mounting positioning aid and depth stop without tools max. plunge depth with position guide 60 mm; Product weight 0,3 kg</p>	500161	1	118,80	1	228001
 <p>Positioning aid/depth stop set, OS-TA/AH Set for OS 400; enables precision positioning and sawing along a scribe mark as well as plunge cuts to a defined depth; positioning aid (500161), depth stop (500160) max. plunge depth, depth stop 56 mm; max. plunge depth, sliding shoe 20 mm; max. plunge depth with position guide 60 mm; notch scale on depth adjuster 1,5 mm; Product weight 0,47 kg</p>	500251	1	142,80	1	228001





Oscillators

Denomination and application	Order no.	PU	Trade price € excl. VAT per PU ¹⁾	SU	DG
------------------------------	-----------	----	--	----	----

Saw blades for OS 400

Wood saw blade

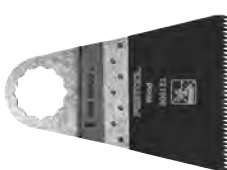
for processing wooden materials; Japan tothing (except HSB 100/HCS); for OS 400

	Length mm	Width mm					
 HSB 50/35/J 5x for OS 400	50	35	500142	5	82,70	1	528001
 HSB 50/45/J 5x for OS 400	50	45	500146	5	85,10	1	528001
 HSB 50/65/J 5x for OS 400	50	65	500145	5	89,30	1	528001
 HSB 100/HCS for OS 400	-	-	500139	1	75,90	1	528001





Metal saw blade

bimetal; with corrugated blade; for machining aluminium and non-ferrous metal; for OS 400

	Length mm	Width mm					
 MSB 50/35/Bi 5x	50	35	500140	5	98,20	1	528001

WOOD UNIVERSAL

bimetal; for processing a range of different materials; for OS 400

	Length mm	Width mm					
 USB 50/35/Bi 5x	50	35	500144	5	69,10	1	528001
 USB 50/65/Bi 5x	50	65	500149	5	75,70	1	528001
 USB 78/32/Bi 5x	78	32	500143	5	64,70	1	528001
 USB 78/42/Bi 5x	78	42	500147	5	67,40	1	528001

* Attention: Festool products with Bluetooth® technology are not available in all countries.
For more information, please contact the official local Festool import partner.
You can find the overview regarding our products and our partners worldwide on our website www.festool.com

PU = Packaging Units
SU = Shipping Units

¹⁾ Manufacturer's recommended retail price.
Dealer prices may vary.

Carpentry machines

Denomination and application

Order no. PU Trade price € excl. VAT SU DG per PU ¹⁾

Carpentry circular saws

HK 132 E portable circular saw



Circular saw, HK 132 E

circular saw blade WOOD STANDARD HW 350 x 3, 5 x 30 W24 (769667), rip fence combined with guide plate extension (769538), extractor connector, Special key tool, ring spanner 19 mm, 10 m power cord

769531 1 2.109,00 1 102004



Circular saw, HK 132/RS-HK

circular saw blade WOOD STANDARD HW 350 x 3, 5 x 30 W24 (769667), rip fence combined with guide plate extension (769538), 10 m power cord, RS-HK 160 x 80 milling set (769540)

561755 1 3.250,00 1 102004

Accessories for carpentry circular saws

Accessories for carpentry circular saws HK 132 E

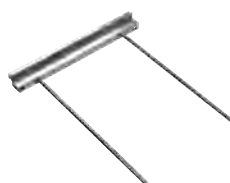

Parallel side fence, PG-HK 132

for HK 132, CSP 132; for using HK 132 E/W with guide rails, type GC 2000/3000

769538 1 136,70 1 202004



Guide rail, GC 2000

for HK 132, CSP 85/60, CSP 132, CSP 165, CCP 380, NRP 90; 2000 mm long

769669 1 266,70 1 213003



Guide rail, GC 3000

for HK 132, CSP 85/60, CSP 132, CSP 165, CCP 380, NRP 90; 3000 mm long

769670 1 368,00 1 213003



Angle stop, GC 1000-WA

for HK 132, CSP 85/60, CSP 132, CSP 165, CCP 380, NRP 90; angle indicator with 1000 mm guide rail and gauge marker; Angle stop, for variable angle adjustment up to 90° on both sides; With gauge marker for adjusting each mitre cut to scribe mark

769671 1 333,50 1 213003

Planer and milling set for HK 132 E



Planing set, NS-HK 250x50

for HK 132, CSP 132; planing head Ø 250 x 500 mm, carbide pre-cutter 14 x 14 x 2.0 mm (769542), carbide reversible blade 50 x 12 x 1.5 mm (769544), protective cover (fixed), protective cover (moveable), clamping rails, pin tool change, 7 x 125 mm screwdriver, hexagon socket wrench planing head dia. 250 mm; planing width 50 mm; planing depth 0-80 mm; drilling 30 mm; Product weight 6,8 kg

769539 1 1.163,80 1 202004

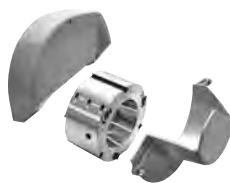

Milling set, RS-HK 160x80

for HK 132, CSP 132; milling head Ø 160 x 80 mm, 3 x carbide reversible blade 80 x 13 x 2.2 mm (769543), carbide pre-cutter 14 x 14 x 2.0 mm (769542), protective cover (fixed), protective cover (moveable), clamping rails, pin tool change, 7 x 125 mm screwdriver, hexagon socket wrench planing head dia. 160 mm; planing width 80 mm; planing depth 0-38 mm; drilling 30 mm; Product weight 7,1 kg

769540 1 1.194,50 1 202004



Reversible cutter blade, CT-HK HW 80x13x2,2/3

dimensions 80 x 13 x 2,2 mm

769543 3 140,20 1 507001

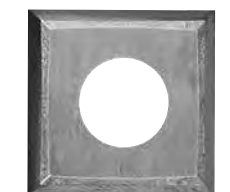

Pre-cutter, CT-HK HW 14x14x2/6

for HK 132, CSP 132, NRP 90; manufactured from carbide dimensions 14 x 14 x 2 mm

769542 6 37,90 1 421001

* Attention: Festool products with Bluetooth® technology are not available in all countries. For more information, please contact the official local Festool import partner. You can find the overview regarding our products and our partners worldwide on our website www.festool.com

PU = Packaging Units
SU = Shipping Units

¹⁾ Manufacturer's recommended retail price. Dealer prices may vary.

Carpentry machines

Denomination and application

Order no. PU Trade price
€ excl. VAT SU DG
per PU ¹⁾

Standard saw blade

for soft and hard wood, chipboard, cement-bonded chipboard, hardboards, gypsum plasterboards

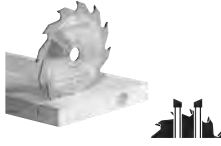

	Diameter mm	Cutting width mm	Hole dia. mm	No. of teeth	Chip angle °					
HW 350x3,5x30 W24 for HK 132, CSP 132	350	3,5	30	24	10	769667	1	98,20	1	502001

Flat tooth saw blade

for steel cable ducts, steel sheeting, steel profiles and multilayered boards

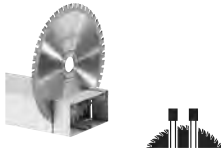

	Diameter mm	Cutting width mm	Hole dia. mm	No. of teeth	Chip angle °					
HW 350x2,9x30 TF60 for HK 132, CSP 132; For multi-layered boards with foam or polystyrene cores and aluminium/steel sheets with max. wall thickness of 2 mm or boards with max. thickness of 130 mm	350	2,9	30	60	0	769668	1	265,10	1	502002

Accessories for hand-held planers

Cutter block with two tri-metal reversible blades



Reversible cutter blade, RN-PL 19x1x205 Tri. 6x for PL 205 E, PLP 205 E; Tri-metal dimensions 19 x 1 x 205 mm	769545	6	103,70	1	507001
Reversible cutter blade, RN-PL 19x1x245 Tri. 6x for PL 245 E, PLP 245 E; Tri-metal dimensions 19 x 1 x 245 mm	769546	6	111,80	1	507001

Accessories for chain mortisers

Chain cutter complete

for CM 150, CMP 150

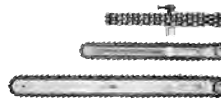

	Slot width or chain width mm	Slot length mm	Slot depth mm					
MF-CM 28x40x100 A	28	40	100	769548	1	811,10	1	523001
MF-CM 28x35x100 A	28	35	100	769547	1	832,30	1	523001
MF-CM 30x30x125 B	28	30	125	769550	1	949,40	1	523001

Chain cutters



	Slot length mm	Slot depth mm					
MC-CM 28x35/40x100 A for chain cutter MF-CM 28 x 35/40 x 100 A, MF-CMP 28 x 35/40 x 100 A; Individual milling machine chain for fittings	35	100	769551	1	372,30	1	523002
MC-CM 28x40x150 A for chain cutter MF-CM 28 x 40 x 150 A, MF-CMP 28 x 40 x 150 A; Individual milling machine chain for fittings	40	150	769552	1	396,50	1	523002
MC-CM 30x30x125 B for chain cutter MF-CM 30 x 30 x 125 B, MF-CMP 30 x 30 x 125 B; Individual milling machine chain for fittings	30	125	769553	1	503,20	1	523002

* Attention: Festool products with Bluetooth® technology are not available in all countries.
For more information, please contact the official local Festool import partner.
You can find the overview regarding our products and our partners worldwide on our website www.festool.com

PU = Packaging Units
SU = Shipping Units

¹⁾ Manufacturer's recommended retail price.
Dealer prices may vary.

Carpentry machines

Denomination and application

Order no. PU Trade price
€ excl. VAT SU DG
per PU ¹⁾



Chain lubrication oil

Chain lubrication oil, CO 1 L

for SSU 200, IS 330, SSP 200, ISP 330, CCP 380; volume 1 litre
in carton

769038	1	10,50	1	516002
--------	---	-------	---	--------

* Attention: Festool products with Bluetooth® technology are not available in all countries.
For more information, please contact the official local Festool import partner.
You can find the overview regarding our products and our partners worldwide on our website www.festool.com





PU = Packaging Units
SU = Shipping Units

¹⁾ Manufacturer's recommended retail price.
Dealer prices may vary.





Preparing the substrate

Denomination and application	Order no.	PU	Trade price		
			€ excl. VAT	SU	DG

Surface-restoration grinders

RENOFIX RG 130 surface-restoration grinder						
	Surface-restoration grinders RENOFIX, RG 130 E-Plus front handle (769080), flange set, KF-AG face wrench (769040), hook-and-loop fastener KV-215 (pack of 5) (205294), Systainer SYS3 L 237 (204848)	576393	1	726,00	1	112001
	Surface-restoration grinders RENOFIX, RG 130 E-Set DIA HD Diamond disc DIA HARD-D130 (768017), front handle (769080), flange set, KF-AG face wrench (769040), hook-and-loop fastener KV-215 (pack of 5) (205294), Systainer SYS3 L 237 (204848)	576395	1	944,00	1	112001
	Surface-restoration grinders RENOFIX, RG 130 E-Set DIA ABR Diamond disc DIA ABRASIVE-D130 (768018), front handle (769080), flange set, KF-AG face wrench (769040), hook-and-loop fastener KV-215 (pack of 5) (205294), Systainer SYS3 L 237 (204848)	576396	1	944,00	1	112001
	Surface-restoration grinders RENOFIX, RG 130 E-Set DIA TH Diamond disc DIA THERMO-D130 (768023), front handle (769080), flange set, KF-AG face wrench (769040), hook-and-loop fastener KV-215 (pack of 5) (205294), Systainer SYS3 L 237 (204848)	576399	1	1.017,00	1	112001

Accessories for surface-restoration grinder



RG 130: diamond discs						
	Diamond disc, DIA HARD-D130 PREMIUM for RG 130, RGP 130, AGP 125; for old solid concrete, removal of epoxy resin from solid surfaces or coatings/paints from concrete diameter 130 mm; interior dia. 25/22,2 mm; active surface 3000 mm ² ; segment height 7 mm	768017	1	218,70	1	412002
	Diamond disc, DIA ABRASIVE-D130 PREMIUM for RG 130, RGP 130, AGP 125; for sand-based materials, screed, fresh concrete, adhesive on screed, sand-lime brick and cellular concrete diameter 130 mm; interior dia. 25/22,2 mm; active surface 3460 mm ² ; segment height 7 mm	768018	1	218,70	1	412002
	Diamond disc, DIA STONE-D130 PREMIUM for RG 130, RGP 130, AGP 125; for extremely hard materials and hard concrete (harder than B 35) diameter 130 mm; interior dia. 25/22,2 mm; active surface 2560 mm ² ; segment height 7 mm	769166	1	218,70	1	412002
	Diamond disc, DIA THERMO-D130 PREMIUM for RG 130, RGP 130, AGP 125; for removing thermoelastic materials diameter 130 mm; interior dia. 25/22,2 mm; segment height 3 mm	768023	1	291,20	1	412002
	Diamond disc, DIA PAINT-D130 PREMIUM for RG 130, RGP 130, AGP 125; for removing thick layers of paint and clear coats from wood diameter 130 mm; interior dia. 25/22,2 mm; segment height 2 mm	204176	1	291,20	1	412002

* Attention: Festool products with Bluetooth® technology are not available in all countries.
For more information, please contact the official local Festool import partner.
You can find the overview regarding our products and our partners worldwide on our website www.festool.com



PU = Packaging Units
SU = Shipping Units

¹⁾ Manufacturer's recommended retail price.
Dealer prices may vary.



Preparing the substrate

Denomination and application		Order no.	PU	Trade price € excl. VAT per PU ¹⁾	SU	DG
	Diamond disc, DIA HARD-D130-ST for RG 130, RGP 130, AGP 125; for old solid concrete, removal of epoxy resin from solid surfaces or coatings/paints from concrete diameter 130 mm; interior dia. 25/22,2 mm; active surface 2300 mm ² ; segment height 5 mm	499972	1	109,70	1	412002
	Diamond disc, DIA ABRASIVE-D130-ST for RG 130, RGP 130, AGP 125; for sand-based materials, screed, fresh concrete, adhesive on screed, sand-lime brick and cellular concrete diameter 130 mm; interior dia. 25/22,2 mm; active surface 2300 mm ² ; segment height 5 mm	499973	1	109,70	1	412002

RG 130: other accessories

	Guide table, GT-RG 130 for RG 130, RGP 130; Enables the material removal capacity rate to be adjusted and thus the removal in defined layers	769080	1	38,80	1	212005
	Brush ring, BC-RG 130 for RG 130, RGP 130; replaceable spare brush rim	769110	1	26,20	1	212005
	Hook-and-loop fastener, KV-215/5 for securing the cable on the suction hose; suitable for suction hoses with a diameter of 27 mm, 32 mm and 36 mm length 215 mm	205294	5	8,30	1	309003

Renovation millers

Renovation miller RENOFIX RG 80						
	Renovation miller RENOFIX, RG 80 E-Plus extraction hood, Auxiliary handle VIBRASTOP (769620), allen key 4, SYS 3 TL Systainer (497565)	768016	1	683,00	1	112001
	Renovation miller RENOFIX, RG 80 E-Set SZ tool head SZ-RG 80 (767982), extraction hood, Auxiliary handle VIBRASTOP (769620), allen key 4, SYS 3 TL Systainer (497565)	768966	1	844,00	1	112001
Renovation miller RENOFIX RG 150						
	Renovation miller RENOFIX, RG 150 E-Plus Puller/removal tool, Socket spanner SW 10/13, SYS 5 TL Systainer (497567)	768019	1	975,00	1	112001
	Renovation miller RENOFIX, RG 150 E-Set SZ tool head SZ-RG 150 (768020), Puller/removal tool, Socket spanner SW 10/13, SYS 5 TL Systainer (497567)	768984	1	1.401,00	1	112001
	Renovation miller RENOFIX, RG 150 E-Set DIA HD tool head DIA HARD-RG 150 (768021), Puller/removal tool, Socket spanner SW 10/13, SYS 5 TL Systainer (497567)	768985	1	1.465,00	1	112001
	Renovation miller RENOFIX, RG 150 E-Set DIA ABR tool head DIA ABRASIVE-RG 150 (768022), Puller/removal tool, Socket spanner SW 10/13, SYS 5 TL Systainer (497567)	768986	1	1.465,00	1	112001

Preparing the substrate

Denomination and application	Order no.	PU	Trade price € excl. VAT per PU ¹⁾	SU	DG
------------------------------	-----------	----	--	----	----

Accessories for renovation millers

RG 80: Tool heads, milling heads, grinding discs

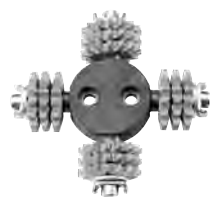

Machine/tool head, SZ-RG 80

for RG 80, RGP 80; for hard plaster, adhesive residues and synthetic resin plaster; 12 carbide cutter wheels "pointed" (769132)
diameter 80 mm

767982 1 160,60 1 212002



Machine/tool head, FZ-RG 80

for RG 80, RGP 80; for soft plaster, fresh concrete, adhesive residues and protective coatings; 12 "flat" carbide-tipped milling heads (769133)
diameter 80 mm

769131 1 160,60 1 212002



Machine/tool head, HW COARSE-RG 80

for RG 80, RGP 80; for elastic coatings, adhesive on soft plaster, plaster and limestone on beams, thick and old layers of paint and roughening GRP; tool head with coarse tungsten-carbide disc
diameter 80 mm

769056 1 142,60 1 212002



Machine/tool head, DIA HARD-RG 80

for RG 80, RGP 80; for old solid concrete, removal of epoxy resin from solid surfaces or coatings/paints from concrete; tool head with hard diamond segments
diameter 80 mm; active surface 1385 mm²; segment height 6 mm

767983 1 237,40 1 212003



Machine/tool head, DIA ABRASIVE-RG 80

for RG 80, RGP 80; for sand-based materials, screed, fresh concrete, adhesive on screed, sand-lime brick and cellular concrete; tool head with abrasive diamond segments
diameter 80 mm; active surface 1385 mm²; segment height 6 mm

767984 1 237,40 1 212003



Machine/tool head, DIA THERMO-RG 80

for RG 80, RGP 80; For thermoelastic materials on concrete, screed, etc.; tool head with THERMO diamond disc
diameter 80 mm; segment height 3 mm

769082 1 313,80 1 212003



Diamond disc, DIA HARD-D80

replacement disc for tool head DIA HARD-RG 80
diameter 80 mm; active surface 1385 mm²; segment height 6 mm

769054 1 184,20 1 412002



Diamond disc, DIA ABRASIVE-D80

replacement disc for tool head DIA ABRASIVE-RG 80
diameter 80 mm; active surface 1385 mm²; segment height 6 mm

769055 1 184,20 1 412002

* Attention: Festool products with Bluetooth® technology are not available in all countries.
For more information, please contact the official local Festool import partner.
You can find the overview regarding our products and our partners worldwide on our website www.festool.com



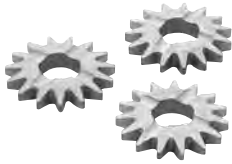
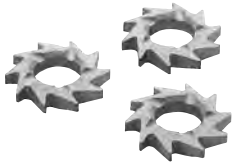

PU = Packaging Units
SU = Shipping Units

¹⁾ Manufacturer's recommended retail price.
Dealer prices may vary.

Preparing the substrate

	Denomination and application	Order no.	PU	Trade price		
				€ excl. VAT per PU ¹⁾	SU	DG
	Diamond disc, DIA-THERMO 80 replacement disc for tool head DIA THERMO-RG 80 diameter 80 mm; segment height 3 mm	769084	1	260,90	1	412002
	Cutter wheel, HW-SZ 12 12 carbide milling heads with "pointed teeth"; replacement heads for SZ-RG 80; complete set with spacer discs and clamping elements	769132	1	121,70	1	412001
	Cutter wheel, HW-FZ 12 complete set with spacer discs and clamping elements; 12 "flat" carbide-tipped milling heads; replacement heads for FZ-RG 80	769133	1	121,70	1	412001

RG 150: tool heads, milling wheels, grinding discs

	Machine/tool head, SZ-RG 150 for RG 150, RGP 150; for hard plaster, adhesive residues and synthetic resin plaster; tool head with 35 carbide milling heads with "pointed teeth" (769050) diameter 150 mm	768020	1	426,50	1	212002
	Machine/tool head, FZ-RG 150 for RG 150, RGP 150; for soft plaster, fresh concrete, adhesive residues and protective coatings; tool head with 35 carbide milling heads with "flat teeth" (769051) diameter 150 mm	769105	1	385,70	1	212002
	Machine/tool head, DIA HARD-RG 150 for RG 150, RGP 150; for old solid concrete, removal of epoxy resin from solid surfaces or coatings/paints from concrete; tool head with hard diamond segments diameter 150 mm; active surface 3660 mm ² ; segment height 11 mm	768021	1	490,00	1	212003
	Machine/tool head, DIA ABRASIVE-RG 150 for RG 150, RGP 150; for sand-based materials, screed, fresh concrete, adhesive on screed, sand-lime brick and cellular concrete; tool head with abrasive diamond segments diameter 150 mm; active surface 3660 mm ² ; segment height 11 mm	768022	1	490,00	1	212003
	Machine/tool head, DIA THERMO-RG 150 for RG 150, RGP 150; For thermoelastic materials on concrete, screed, etc.; tool head with THERMO diamond disc diameter 150 mm; segment height 3 mm	769083	1	622,10	1	212003

* Attention: Festool products with Bluetooth® technology are not available in all countries.
For more information, please contact the official local Festool import partner.
You can find the overview regarding our products and our partners worldwide on our website www.festool.com

PU = Packaging Units
SU = Shipping Units

¹⁾ Manufacturer's recommended retail price.
Dealer prices may vary.

Preparing the substrate

Denomination and application		Order no.	PU	Trade price € excl. VAT per PU ¹⁾	SU	DG
	Diamond disc, DIA HARD-D150 replacement disc for tool head DIA HARD-D150 diameter 150 mm; active surface 3660 mm ² ; segment height 11 mm	769069	1	394,60	1	412002
	Diamond disc, DIA ABRASIVE-D150 replacement disc for tool head DIA ABRASIVE-D150 diameter 150 mm; active surface 3660 mm ² ; segment height 11 mm	769070	1	394,60	1	412002
	Diamond disc, DIA THERMO-D150 replacement disc for tool head DIA THERMO-D150 diameter 150 mm; segment height 3 mm	769085	1	527,00	1	412002
	Cutter wheel, HW-SZ 35 35 carbide milling heads with "pointed teeth"; replacement heads for SZ-RG 150; complete set with running sleeves	769050	1	294,50	1	412001
	Cutter wheel, HW-FZ 35 35 "flat carbide-tipped milling heads"; replacement heads for FZ-RG 150; complete set with running sleeves	769051	1	251,10	1	412001
RG 150: other accessories						
	Balancer, BR-RG 150 for RG 150, RGP 150; for secure and simple guidance of the RENOFIX RG 150 E on the wall max. load 8 kg; length 2,5 m	769121	1	236,80	1	212005
	Brush ring, BC-RG 150 for RG 150, RGP 150; replaceable spare brush rim	769123	1	22,00	1	212005
	Floor guide, BG-RG 150 for RG 150, RGP 150; for easy guidance of RENOFIX RG 150 E over large areas	769109	1	415,10	1	212004

* Attention: Festool products with Bluetooth® technology are not available in all countries.
For more information, please contact the official local Festool import partner.
You can find the overview regarding our products and our partners worldwide on our website www.festool.com

PU = Packaging Units
SU = Shipping Units

¹⁾ Manufacturer's recommended retail price.
Dealer prices may vary.

Preparing the substrate

Denomination and application	Order no.	PU	Trade price € excl. VAT per PU ¹⁾	SU	DG
------------------------------	-----------	----	--	----	----

Diamond grinding system

Accessories for diamond grinding system



Dust extraction attachment, DCG-AG 125 for AG 125, AGP 125-12/14; Clamping flange disc dia. 125/130 mm; Product weight 0,4 kg; dust extraction connection dia. 36/27 mm	769076	1	96,30	1	217001
Brush ring, BC-DCG AG 125 for DCG-AGP 125	769081	1	20,80	1	217001

Wallpaper perforator

Wallpaper perforator TP 220





Wallpaper perforator, TP 220 protective cover, telescoping handle	495747	1	174,10	1	212006
---	--------	---	--------	---	--------

Accessories for wallpaper perforator



Accessories for wallpaper perforator





Replacement roller, EW-TP 220 for TP 220; 2 x rollers	496111	1	46,10	1	412005
---	--------	---	-------	---	--------

Denomination and application	Order no.	PU	Trade price € excl. VAT per PU ¹⁾	SU	DG
Cordless angle grinder					
AGC 18 cordless angle grinder you can find the compatible batteries and chargers available as accessories under "Battery and charging technology"					
	Cordless angle grinder, AGC 18-125 EB-Basic without battery pack, without charger, guard SH-AGC 18 (203384), Auxiliary handle VIBRASTOP (769620), QNR-AGC 18 quick-acting clamping nut (204927), flange BF-AGC 18 (204119), KF-AGC 18 face wrench (204929), Systainer SYS3 M 187 (204842)	576825	1	322,00	1 117003
	Cordless angle grinder, AGC 18-125 5,2 EB-Plus 2 x BP 18 Li 5.2 AS battery pack (200181), rapid charger TCL 6 (201135), guard SH-AGC 18 (203384), Auxiliary handle VIBRASTOP (769620), QNR-AGC 18 quick-acting clamping nut (204927), flange BF-AGC 18 (204119), KF-AGC 18 face wrench (204929), Systainer SYS3 M 187 (204842)	576826	1	590,00	1 117003



Accessories for cordless angle grinder

Clamping flange, face wrench					
	Keyless flange nut, QNR-AGC 18 M14 for AGC 18; for disc diameter 115 – 125 mm; front clamping flange; sanders clamped without using tools holder M14	204927	1	26,90	1 217001
	Flange, BF-AGC M14 for AGC 18; for M14 spindle threads; rear clamping flange; for clamping sanders holder dia. 22,23 mm	204119	1	8,30	1 217001

Auxiliary handles					
	Auxiliary handle, AH-M8 VIBRASTOP for AGC 18, DSC-AGC 18 FH, DSC-AG 125, DSC-AG 125 FH; VIBRASTOP holder M8	769620	1	12,60	1 217001

Other accessories					
	Protective cover, SH-AGC 18-125 for AGC 18; for grinding work with flap discs and roughing discs disc dia. 125 mm	203384	1	9,20	1 217001
	Separating protective cover, TSH-AGC 18-125 for AGC 18; for safe work with cutting discs made of bonded abrasives disc dia. 125 mm	203378	1	30,10	1 217001



Cutting

Denomination and application	Order no.	PU	Trade price		
			€ excl. VAT	SU	DG
 <p>Spanner, KF-AGC 18 for AGC 18; for flange</p>	204929	1	13,40	1	217001
 <p>Hand protection, HS-AGC 18 for AGC 18; for safe work with wire brushes</p>	205193	1	10,80	1	217001



Cordless freehand cutting system

<p>DSC-AGC 18 FH cordless diamond cutting system you can find the compatible batteries and chargers available as accessories under "Battery and charging technology"</p>					
 <p>Cordless freehand cutting system, DSC-AGC 18-125 FH Li EB-Basic without battery pack, without charger, extraction hood, ALL-D125 Premium diamond cutting disc (769154), plate TP-DSC-AG 125 FH (200002), Auxiliary handle VIBRASTOP (769620), clamping nut UF-AG M14 (769018), flange BF-DSC-AGC M14 (204121), KF-AG face wrench (769040), SYS 3 TL Systainer (497565)</p>	575759	1	423,00	1	117003
<p>Cordless freehand cutting system, DSC-AGC 18-125 FH EB-Basic without battery pack, without charger, extraction hood, ALL-D125 Premium diamond cutting disc (769154), plate TP-DSC-AG 125 FH (200002), Auxiliary handle VIBRASTOP (769620), clamping nut UF-AG M14 (769018), flange BF-DSC-AGC M14 (204121), KF-AG face wrench (769040), Systainer SYS3 M 187 (204842)</p>	576829	1	438,00	1	117003



Diamond cutting systems

<p>Diamond cutting system DSC-AG 125</p>					
 <p>Diamond cutting system, DSC-AG 125 Plus extraction hood DCC-AG 125 (769075), ALL-D125 Premium diamond cutting disc (769154), SYS 4 TL Systainer (497566)</p>	767996	1	364,00	1	117001
 <p>Diamond cutting system, DSC-AG 125 Plus-FS ALL-D125 Premium diamond cutting disc (769154), extraction hood DCC-AG 125 (769075), guide rail FS 800/2 (491499), SYS 4 TL Systainer (497566)</p>	768993	1	430,00	1	117001
<p>Diamond cutting system DSC-AG 125 FH</p>					
 <p>Freehand cutting system, DSC-AG 125 FH-Plus extraction hood DCC-AG 125 FH (769953), ALL-D125 Premium diamond cutting disc (769154), plate TP-DSC-AG 125 FH (200002), Auxiliary handle VIBRASTOP (769620), SYS 3 TL Systainer (497565)</p>	769954	1	324,00	1	117001



Cutting

Denomination and application	Order no.	PU	Trade price € excl. VAT per PU ¹⁾	SU	DG
Diamond cutting system DSC-AG 230					
 <p>Diamond cutting system, DSC-AG 230 extraction hood DCC-AG 230 (769077), ALL-D230 Premium diamond cutting disc (769155), case</p>	767997	1	583,00	1	117001
 <p>Diamond cutting system, DSC-AG 230 FS extraction hood DCC-AG 230 (769077), ALL-D230 Premium diamond cutting disc (769155), case, guide rail FS 800/2 (491499)</p>	769001	1	647,00	1	117001

Accessories for diamond cutting systems

Extraction hoods					
 <p>Dust extraction attachment, DCC-AG 125 for AG 125, AGP 125-12/14; for the reduction of dust; hexagon socket wrench, KF-AG face wrench (769040), Clamping flange Product weight 2,2 kg; dust extraction connection dia. 36/27 mm; diameter 125 mm</p>	769075	1	179,30	1	217001
 <p>Dust extraction attachment, DCC-AG 125 FH for DSC-AG 125, DSC-AG 125 FH and AG 125; for dust-free work with the angle grinder; hexagon socket wrench dust extraction connection dia. 36/27 mm; Product weight 0,6 kg; diameter 125 mm</p>	769953	1	107,00	1	217001
 <p>Dust extraction attachment, DCC-AG 230 for AG 230, AGP 230-22/26; for the reduction of dust; hexagon socket wrench, Clamping flange, Spanner Product weight 3,2 kg; dust extraction connection dia. 36/27 mm; diameter 230 mm</p>	769077	1	215,00	1	217001

Clamping flange, face wrench



 <p>Clamping nut, UF-AG M14 for disc Ø 115 – 230 mm; for DSC-AGC 18 FH, DSC-AG 125/230 (manufactured up to 02/2015) and RG 130 (manufactured up to 02/2015); front clamping flange; for clamping the grinding disc holder M14</p>	769018	1	9,10	1	217001
 <p>Clamping nut, UF-DSC/DSG-AG M14 for disc Ø 115 – 230 mm; for DSC-AG 125/230 (manufactured from 03/2015) and RG 130 (manufactured from 03/2015); front clamping flange; for clamping the grinding disc holder M14</p>	200241	1	9,10	1	217001

* Attention: Festool products with Bluetooth® technology are not available in all countries.
For more information, please contact the official local Festool import partner.
You can find the overview regarding our products and our partners worldwide on our website www.festool.com

PU = Packaging Units
SU = Shipping Units

¹⁾ Manufacturer's recommended retail price.
Dealer prices may vary.

Cutting

Denomination and application	Order no.	PU	Trade price		
			€ excl. VAT	SU	DG
 <p>Flange, BF-AG 22,2 for disc Ø 115 – 230 mm; for DSC-AG 125/230; rear clamping flange; for clamping the grinding disc holder dia. 22,23 mm</p>	767973	1	5,80	1	217001
 <p>Flange, BF-DSC-AGC M14 for DSC-AGC 18 FH; for M14 spindle threads; rear clamping flange; for clamping the grinding disc holder dia. 22,23 mm</p>	204121	1	8,30	1	217001
 <p>Spanner, KF-AG for DSC-AGC 18 FH, DSC-AG 125/230, RG 130; for flange</p>	769040	1	7,50	1	217001

Additional handles for cutting system



 <p>Auxiliary handle, AH-M8 VIBRASTOP for AGC 18, DSC-AGC 18 FH, DSC-AG 125, DSC-AG 125 FH; VIBRASTOP holder M8</p>	769620	1	12,60	1	217001
<p>Auxiliary handle, AH-M14 VIBRASTOP for DSC-AG 230; VIBRASTOP holder M14</p>	769621	1	17,10	1	217001

Other accessories

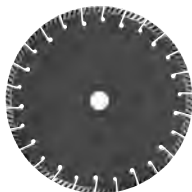

 <p>Plate, TP-DSC-AG 125 FH for DSC-AG 125 FH Plus, DCC-AG 125 FH, DSC-AGC 18 FH; protects the surface against possible signs of abrasion during cutting; for fastening at guide table of extraction hood dimensions (L x W x H) 195 x 103 x 14 mm</p>	200002	1	15,70	1	217001
---	--------	---	-------	---	--------

Diamond discs for diamond cutting system

Diamond cutting discs

 <p>Diamond cutting disc, ALL-D 125 PREMIUM for AGC 18, DSC-AGC 18 FH, DSC-AG 125, DSC-AG 125 FH; universal range of applications hole dia. 22,23 mm; diameter 125 mm; cutting width 2 mm; segment height 10 mm</p>	769154	1	78,30	1	517006
 <p>Diamond cutting disc, C-D 125 PREMIUM for AGC 18, DSC-AGC 18 FH, DSC-AG 125, DSC-AG 125 FH; for concrete diameter 125 mm; hole dia. 22,23 mm; cutting width 2,2 mm; segment height 10 mm</p>	769158	1	91,70	1	517006
 <p>Diamond cutting disc, MJ-D125 PREMIUM for DSC-AG 125, DSC-AG 125 FH; For cleaning grouted joints. diameter 125 mm; hole dia. 22,23 mm; cutting width 6,5 mm; segment height 10 mm</p>	769087	1	105,10	1	517006

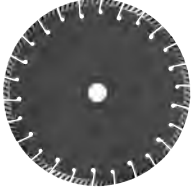
Cutting

Denomination and application		Order no.	PU	Trade price € excl. VAT per PU ¹⁾	SU	DG
   	Diamond cutting disc, TL-D125 PREMIUM for AGC 18, DSC-AGC 18 FH, DSC-AG 125, DSC-AG 125 FH; suitable for cutting floor tiles, roof tiles and concrete roofing tiles diameter 125 mm; hole dia. 22,23 mm; cutting width 1,2 mm; segment height 10 mm	769162	1	52,10	1	517006
	Diamond cutting disc, ALL-D 230 PREMIUM for DSC-AG 230, AGP 230; universal range of applications diameter 230 mm; hole dia. 22,23 mm; cutting width 2,4 mm; segment height 9 mm	769155	1	144,00	1	517006
	Cut-off wheel, WS D 125/10 for AGC 18; for cutting steel and stainless steel diameter 125 mm; hole dia. 22,23 mm; cutting width 1 mm	204902	10	38,60	1	517004
	Cut-off wheel, WS D 115/10 for AGC 18; for cutting steel and stainless steel diameter 115 mm; hole dia. 22,23 mm; cutting width 1 mm	204903	10	34,30	1	517004

* Attention: Festool products with Bluetooth® technology are not available in all countries.
 For more information, please contact the official local Festool import partner.
 You can find the overview regarding our products and our partners worldwide on our website www.festool.com

PU = Packaging Units
 SU = Shipping Units

¹⁾ Manufacturer's recommended retail price.
 Dealer prices may vary.

Denomination and application

Order no. PU Trade price € excl. VAT per PU ¹⁾ SU DG

Edge bander



Edge bander CONTURO KA 65

Edge bander CONTURO, KA 65-Plus

front handle, 4 x EVA adhesive, natural, Systainer SYS3 M 337 [204844]

576574 1 2.634,00 1 127001

Edge bander CONTURO, KA 65-Set

front handle, 4 x EVA adhesive, natural, protective edging [499479], 20x StickFix Granat 80 x 133 P320 abrasive sheets, additional roll [499480], HSK 80 x 133 H sanding block [495967], trimming device [499896], scraper [499749], base runner scratch protector with 3x felt layers [499892], polishing felt [499894], S 800 StickFix sanding cloth [483582], MPA 5010 OR polish [202048], Systainer SYS3 M 337 [204844]

576580 1 3.088,00 1 127001

Accessories for edge bander KA 65

Accessories for edge bander KA 65



Multifunction table, MFT/3 Conturo-AP

for KA 65; table with perforated top and foldaway legs; for using the edge bander CONTURO KA 65 as a bench-mounted machine; adapter plate AP-KA 65 [500175], cross brace QT-MFT/3 [495502]
table dimensions 1157 x 773 mm; work height 900 mm; swivel-mounted edge bander 47 °; Product weight 29 kg

500869 1 950,80 1 205010



Magazine for holding edging, KSP-KA 65

for KA 65; for the safe guidance of delicate and thin edging into the edge bander KA 65; safe guidance of long edges without damaging or soiling; max. edge lengths of 8 m (edge thickness of 2 mm) possible
max. edge height 45 mm; max. edge thickness 2 mm

499479 1 56,90 1 227001



Additional roll, ZR-KA 65

for KA 65; for affixing edging to tight curves and shaped parts; offers additional pressure point for applying more pressure on the edge of the board when glued
roll height 65 mm

499480 1 68,00 1 227001



Scratch protector, LAS-STF-KA 65

for KA 65; 4 x retaining screws, 3 x felt pads

499892 1 32,80 1 227001



Spare felt, EF-LAS-STF-KA 65 10x

for scratch protector LAS-STF-KA 65

499893 10 27,90 1 227001



Scraper, ZK HW 45/45

dimensions (L x W x H) 45 x 45 x 1,2 mm; curves 1/1,5/2 mm; dimensions 45 x 45 mm

499749 1 59,30 1 227001



Polishing felt, PF-STF 80x133 STF H/5

for hand sanding block HSK 80 x 133; in conjunction with the MPA 5010 polishing agent; for polishing high-gloss edges
dimensions length x width 80 x 133 mm

499894 5 17,00 1 508009







Sanding block, HSK 80x133 H

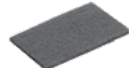

hard; for attaching StickFix 80 x 133 mm abrasive sheets

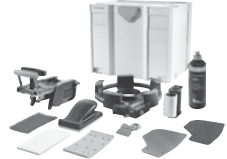
495967 1 25,60 1 408004

Edging



Denomination and application		Order no.	PU	Trade price € excl. VAT per PU ¹⁾	SU	DG
 <p>Vlies</p>  <p>80 x 130 mm</p>   	Sanding vlies, STF 80x130 SF 800 VL/5 for RTS 400, RTSC 400, RS 400, RS 4, LS 130, HSK-A 80 x 130, HSK 80 x 133 grit 800; dimensions 80 x 130 mm	483582	5	9,80	1	508006
	Trimming machine, KP 65/2 Impact trimming function (for round tables) and trimming of panel edges (final trimming) with a single machine; for trimming plastic edging with a height of 18 - 65 mm and a thickness of 0.5 - 2.0 mm (depending on material); for PVC, acrylic and thin wooden veneer edging (depending on material) trimming height 65 mm; trimming thickness 2 mm	499896	1	171,30	1	227001
	Edge trimming set, KB-KA 65 SYS for KA 65; protective edging (499479), 20x StickFix Granat 80 x 133 P320 abrasive sheets, additional roll (499480), HSK 80 x 133 H sanding block (495967), trimming device (499896), scraper (499749), base runner scratch protector with 3x felt layers (499892), polishing felt (499894), S 800 StickFix sanding cloth (483582), SYS 4 TL Systainer (497566), MPA 5010 OR polish (202048)	500177	1	451,60	1	227001
	Edge trimming set, KB-KA 65 SYS3 for KA 65; protective edging (499479), 20x StickFix Granat 80 x 133 P320 abrasive sheets, additional roll (499480), HSK 80 x 133 H sanding block (495967), trimming device (499896), scraper (499749), base runner scratch protector with 3x felt layers (499892), polishing felt (499894), S 800 StickFix sanding cloth (483582), MPA 5010 OR polish (202048), Systainer SYS3 M 337 (204844)	576834	1	453,80	1	227001

Bench units

  	Adapter plate, AP-KA 65 for KA 65; for using the edge bander KA 65 as a bench-mounted machine; adapter plate for installation in the MFT (with perforated board KA 65, order no. 500366) or a separate workbench; mounting plate for edge bander complete with 15 sliding guides (500367), additional roll (499480) dimensions length x width 254 x 420 mm; min. installation height 150 mm; cutting angle adjustment 0 - 47 °	500175	1	366,80	1	227001
	Perforated top, LP-KA65 MFT/3 for KA 65; allows the user to swivel the machine (0 - 47°) in the bench in combination with the AP-KA 65 adapter plate and therefore position the workpiece horizontally during edging - for convenient and safe guidance, even with larger objects dimensions length x width 1102 x 718 mm	500366	1	158,30	1	227001
	Crossheaded guide, GP-MFT/3 KA65 15x replacement or extension slide plates for stationary use of the edge bander with the AP-KA 65 adapter plate in the MFT (with KA 65 perforated board, order no. 500366) or installed in a separate workbench dimensions (L x W x H) 255 x 31 x 6 mm	500367	15	28,60	1	227001

Adhesive

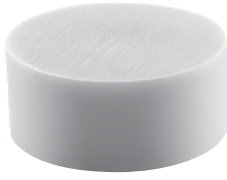
Hot melt





 	EVA adhesive, natural, EVA nat 48x-KA 65 for KA 65; unfilled EVA adhesive - natural colour tone suitable for all types of decor; EVA universal adhesive with high melting point; high softening range of approx. 90 °C, therefore also suitable for use on objects with a relatively high temperature resistance from -10 °C to +75 °C; chemical basis: Adhesive, resin adhesive diameter 63 mm; adhesive height 26 mm; processing temperature 190 °C; moisture resistance in accordance with D1	499812	48	118,30	1	427001
	EVA adhesive, white, EVA wht 48x-KA 65 for KA 65; Unfilled EVA adhesive - perfect join quality on white decor; EVA universal adhesive with high melting point; high softening range of approx. 90 °C, therefore also suitable for use on objects with a relatively high temperature resistance from -10 °C to +75 °C; chemical basis: Adhesive, resin adhesive diameter 63 mm; adhesive height 26 mm; processing temperature 190 °C; moisture resistance in accordance with D1	499813	48	118,30	1	427001

* Attention: Festool products with Bluetooth® technology are not available in all countries. For more information, please contact the official local Festool import partner. You can find the overview regarding our products and our partners worldwide on our website www.festool.com

PU = Packaging Units
SU = Shipping Units

¹⁾ Manufacturer's recommended retail price. Dealer prices may vary.

Edging

Denomination and application		Order no.	PU	Trade price € excl. VAT per PU ¹⁾	SU	DG
	<p>EVA adhesive, brown, EVA brn 48x-KA 65 for KA 65; Unfilled EVA adhesive – perfect join quality on brown decor; EVA universal adhesive with high melting point; high softening range of approx. 90 °C, therefore also suitable for use on objects with a relatively high temperature resistance from -10 °C to +75 °C; chemical basis: Adhesive, resin adhesive diameter 63 mm; adhesive height 26 mm; processing temperature 190 °C; moisture resistance in accordance with D1</p>	200059	48	118,30	1	427001
	<p>EVA adhesive, black, EVA blk 48x-KA 65 for KA 65; Unfilled EVA adhesive – perfect join quality on black decor; EVA universal adhesive with high melting point; high softening range of approx. 90 °C, therefore also suitable for use on objects with a relatively high temperature resistance from -10 °C to +75 °C; chemical basis: Adhesive, resin adhesive diameter 63 mm; adhesive height 26 mm; processing temperature 190 °C; moisture resistance in accordance with D1</p>	200060	48	118,30	1	427001
PU adhesive						
	<p>PU adhesive, natural, PU nat 4x-KA 65 for KA 65; caution: use rinsing agent to clean machine after use (PU spm 4x KA65, number 200062); can be stored for a maximum of 12 months; adhesive has high initial strength, and cold elasticity, and good solvent resistance; natural colour tone; PU adhesive packed in 200 g airtight containers; chemical basis: Polyurethane adhesive; caution! The polyurethane adhesive provided here contains "o-(p-isocyanatobenzyl)phenyl isocyanate; diphenylmethane-2,4'-diisocyanate" and as a result is labelled with the R40 phrase "Limited evidence of a carcinogenic effect". We are obligated by the Chemikalien-Verbotsverordnung (German Chemicals Prohibition Ordinance) to draw your attention to the presence of hazardous substances in our polyurethane adhesive no. 200056. By purchasing said polyurethane adhesive, you are confirming that you are at least 18 years old, that you shall use the PU adhesive properly and protect skin, eyes and mucous membranes from direct contact with it, e.g. by wearing protective goggles, respiratory protection/mask and disposable gloves. We are trained and assessed in accordance with Section 5 of the Chemicals Prohibition Ordinance adhesive diameter 63 mm; adhesive height 42 mm; processing temperature 140 °C; temperature resistance -40°C – +140° C; softening range 90 °C</p>	200056	4	65,00	1	427001
	<p>Rinsing agent, PU spm 4x-KA 65 for KA 65; rinsing cartridge for the CONTURO KA 65 edge bander after use of PU adhesive, natural, PU nat 4x-KA 65; must be used after PU adhesive use to stop remaining PU adhesive chemically reacting; can be stored for a maximum of 12 months; packaged in 140 g containers Product weight 0,56 kg</p>	200062	4	53,00	1	427001

* Attention: Festool products with Bluetooth® technology are not available in all countries.
For more information, please contact the official local Festool import partner.
You can find the overview regarding our products and our partners worldwide on our website www.festool.com

PU = Packaging Units
SU = Shipping Units

¹⁾ Manufacturer's recommended retail price.
Dealer prices may vary.

Denomination and application	Order no.	PU	Trade price € excl. VAT per PU ¹⁾	SU	DG
------------------------------	-----------	----	--	----	----

Routers

Router OF 1010 R

you can find the right guide rails and accessories in the "Workplace organisation" section



Router, OF 1010 REBQ Ø 8 mm clamping collet (488755), side stop (489427), open ended spanner, WAF 19	576925	1	486,00	1	106001
Router, OF 1010 REBQ-Plus Ø 8 mm clamping collet (488755), side stop (489427), guide rail adapter, chip deflector (493180), open ended spanner, WAF 19, Systainer SYS3 M 237 (204843)	576919	1	525,00	1	106001
Router, OF 1010 REBQ-Set Ø 8 mm clamping collet (488755), side stop (489427), guide rail adapter, chip deflector (493180), open ended spanner, WAF 19, guide rail FS 800/2 (491499), Systainer SYS3 M 237 (204843)	577168	1	590,00	1	106001
Router, OF 1010 REBQ-Set+Box Ø 8 mm clamping collet (488755), side stop (489427), guide rail adapter, chip deflector (493180), router bit box (498979), open ended spanner, WAF 19, guide rail FS 800/2 (491499), Systainer SYS3 M 237 (204843)	577186	1	814,00	1	106001

Router OF 1010

you can find the right guide rails and accessories in the "Workplace organisation" section



Router, OF 1010 EBQ-Plus Ø 8 mm clamping collet (488755), side stop (489427), guide rail adapter, chip deflector (493180), open ended spanner, WAF 19, Systainer SYS3 M 237 (204843)	576196	1	473,00	1	106001
Router, OF 1010 EBQ-Set Ø 8 mm clamping collet (488755), side stop (489427), guide rail adapter, chip deflector (493180), open ended spanner, WAF 19, guide rail FS 800/2 (491499), Systainer SYS3 M 237 (204843)	576201	1	536,00	1	106001
Router, OF 1010 EBQ-Plus+Box-OF-S Ø 8 mm clamping collet (488755), side stop (489427), guide rail adapter, chip deflector (493180), router bit box (498979), open ended spanner, WAF 19, Systainer SYS3 M 237 (204843)	576538	1	688,00	1	106001
Router, OF 1010 EBQ-Set+Box-OF-S Ø 8 mm clamping collet (488755), side stop (489427), guide rail adapter, chip deflector (493180), router bit box (498979), open ended spanner, WAF 19, guide rail FS 800/2 (491499), Systainer SYS3 M 237 (204843)	576539	1	751,00	1	106001

* Attention: Festool products with Bluetooth® technology are not available in all countries.
 For more information, please contact the official local Festool import partner.
 You can find the overview regarding our products and our partners worldwide on our website www.festool.com

PU = Packaging Units
 SU = Shipping Units

¹⁾ Manufacturer's recommended retail price.
 Dealer prices may vary.



Routing

Denomination and application		Order no.	PU	Trade price € excl. VAT per PU ¹⁾	SU	DG
Router OF 1400 you can find the right guide rails and accessories in the "Workplace organisation" section						
	Router, OF 1400 EBQ-Plus chip deflector [492732], Ø 8 mm clamping collet [494460], Ø 12 mm clamping collet [494462], side stop with fine setting [492636], copying ring Ø 30 mm [492185], extraction hood, top, open ended spanner, WAF 24, Systainer SYS3 M 337 [204844]	576207	1	681,00	1	106001
	Router, OF 1400 EBQ-Plus + Box-OF-S Ø 8 mm clamping collet [494460], Ø 12 mm clamping collet [494462], side stop with fine setting [492636], copying ring Ø 30 mm [492185], extraction hood, top, chip deflector [492732], router bit box [498979], open ended spanner, WAF 24, Systainer SYS3 M 337 [204844]	576540	1	905,00	1	106001











Router OF 2200 you can find the right guide rails and accessories in the "Workplace organisation" section						
	Router, OF 2200 EB-Plus Ø 8 mm clamping collet [494460], Ø 12 mm clamping collet [494462], copying ring Ø 30 mm [494625], chip deflector [494670], open ended spanner, WAF 24, Systainer SYS3 M 337 [204844]	576215	1	952,00	1	106001
	Router, OF 2200 EB-Set Ø 12 mm clamping collet [494462], Ø 8 mm clamping collet [494460], copying ring Ø 30 mm [494625], chip deflector [494670], Systainer accessories [576832], open ended spanner, WAF 24, Systainer SYS3 M 337 [204844]	576220	1	1.375,00	1	106001

Accessories for routers

Storage system for cutters with size 8 shank						
	Router bit box, Box-OF HW S8 Mix edge trimming cutter HW D12.7/NL25 KL [491027], dowel drill HW D5 x 30 Z [491066], groove cutter HW D10/20 with drill point [490959], groove cutter HW D18/30 with drill point [490969], classic ogee cutter HW D16.7/R2 KL [491009], classic ogee cutter HW D25.5 R6.3 KL [491013], classic ogee cutter HW D31.7/R9.5 KL [491015], chamfer cutter HW D36/45° KL [491025], groove cutting disc HW D40 x 4 [491059], dovetail cutter HW D13.8/15° [490992]	498979	1	224,10	1	506001

Stops and circles						
  	guide rail adapter, FS-OF 1000 complete with support; for use of routers OF 900, OF 1000, OF 1010, OF 1010 R with the FS guidance system; without rods	488752	1	38,60	1	206002
	Fine adjuster for guide stop, FE-FS/OF 1000 for OF 900, OF 1000, OF 1010, OF 1010 R, KF	488754	1	26,30	1	206002
	Guide rail adapter, FS-OF 1400 for OF 1400; with fine adjustment and support for router without guide rods; without rods	492601	1	65,50	1	206002

Routing

Denomination and application		Order no.	PU	Trade price € excl. VAT per PU ¹⁾	SU	DG
	Guide rail adapter, FS-OF 2200 for OF 2200; Without guide rods ST-OF 2200/2; With fine adjustment and support plate for router	494681	1	127,80	1	206002
	Parallel side fence, SA-OF 1000 for OF 900, OF 1000, OF 1010, OF 1010 R, KF; with 2 guide rods	489427	1	44,90	1	206002
	Parallel side fence, SA-OF 1400 for OF 1400; With fine adjustment and extraction hood; without rods	492636	1	49,50	1	206002
	Parallel side fence, SA-OF 2200 for OF 2200; With fine adjustment and extraction hood; Without guide rods ST-OF 2200/2	494680	1	107,80	1	206002
	Rod, ST-OF 2200/2 for OF 2200; guide rods for side and guide stops 2 pieces	495247	1	21,50	1	206002
	Fine adjuster for parallel side fence, FE-OF 1000/KF for OF 900, OF 1000, OF 1010, OF 1010 R, KF; for fast and dimensionally accurate adjustment on the parallel side fence; can be retrofitted; delivered without side stop and guide rods	483358	1	35,30	1	206002
	Trammel unit, SZ-OF 1000 for OF 900, OF 1000, OF 1010, OF 1010 R, KF; for cutting radii, circles and decorative curves on surfaces and edges circle dia. 153 – 760 mm	483922	1	23,40	1	206002
	Systainer³, SYS3-OF D8/D12 with foam insert; for safe storage of cutters D 8, D 12 dimensions (L x W x H) 396 x 296 x 112 mm; inner dimensions (L x W x H) 389 x 275 x 71 mm; SYSTAINER size SYS3 M 112	576835	1	82,10	1	214001
Other accessories						
	Base runner, TP-OF for OF 900, OF 1000, OF 1010, KF; not compatible with OF 1010 R; hard fibre base runner; centre hole Ø 15 mm	489229	1	15,80	1	206002
	Base runner, LA-OF 1400 for OF 1400; hard-fibre base runner with 20 mm centre bore; reduces the opening of the router to the cutter diameter max. cutter diameter 37 mm	492574	1	32,10	1	206002
	Base runner, LA-OF 2200 D36 CT for OF 2200; for copying rings < 30 mm; With openings for optimised extraction	494675	1	59,20	1	206002

* Attention: Festool products with Bluetooth® technology are not available in all countries.
For more information, please contact the official local Festool import partner.
You can find the overview regarding our products and our partners worldwide on our website www.festool.com

PU = Packaging Units
SU = Shipping Units

¹⁾ Manufacturer's recommended retail price.
Dealer prices may vary.

Routing



Denomination and application	Order no.	PU	Trade price € excl. VAT per PU ¹⁾	SU	DG
 <p>Base runner, LA-OF 2200 D36 for OF 2200; reduces the opening of the router to the cutter diameter</p>	494677	1	59,20	1	206002
 <p>Base runner, LAS-OF 1400 for OF 1400; for sideway extraction; running pad with support extension; running pad with chip deflector max. aperture 63 mm</p>	493233	1	116,10	1	206002
 <p>Routing aid, OF-FH 2200 for OF 900, OF 1000, OF 1010, OF 1400, OF 2000, OF 2200; safe guidance of the router thanks to the movable legs</p>	495246	1	227,10	1	206002
 <p>Dust extraction attachment, AH-OF 1000 for OF 900, OF 1000, OF 1010, OF 1010 R, KF; for jointing system VS 500 / VS 600 and for edge trimming</p>	484453	1	22,90	1	206002
 <p>Dust extraction attachment, AH-OF 1400 for OF 1400 / VS 600; for sideway extraction</p>	492585	1	41,40	1	206002
 <p>Chip deflector, KSF-OF 1010 for OF 900, OF 1000, OF 1010, OF 1010 R; for sideway extraction max. aperture 37 mm</p>	493180	1	20,50	1	206002
 <p>Chip deflector, KSF-OF 1400 for OF 1400; for sideway extraction</p>	492732	1	20,30	1	206002
 <p>Chip deflector, KSF-OF 2200 for OF 2200; for sideway extraction max. cutter diameter 80 mm</p>	494670	1	42,70	1	206002

* Attention: Festool products with Bluetooth® technology are not available in all countries.
For more information, please contact the official local Festool import partner.
You can find the overview regarding our products and our partners worldwide on our website www.festool.com

PU = Packaging Units
SU = Shipping Units

¹⁾ Manufacturer's recommended retail price.
Dealer prices may vary.

Routing

Denomination and application	Order no.	PU	Trade price		
			€ excl. VAT	SU	DG
 <p>Support, AFB-OF 2200 for OF 2200; support widener for safe guidance of the router at workpiece edges</p>	494682	1	70,80	1	206002
 <p>Accessories set, ZS-OF 2200 M for OF 2200; guide rail adapter, parallel side fence with fine adjustment and extraction hood, Guide rods, copying ring Ø 17 mm (494622), copying ring Ø 24 mm (494623), copying ring Ø 27 mm (494624), copying ring Ø 40 mm (494626), base runner D36, base runner for copying rings, extension, SYS 3 TL Systainer (497565)</p>	497655	1	420,60	1	206010
 <p>Accessories set, ZS-OF 2200 for OF 2200; guide rail adapter, parallel side fence with fine adjustment and extraction hood, Guide rods, copying ring Ø 17 mm (494622), copying ring Ø 24 mm (494623), copying ring Ø 27 mm (494624), copying ring Ø 40 mm (494626), base runner D36, base runner for copying rings, extension, Systainer SYS3 M 237 (204843)</p>	576832	1	422,80	1	206010

OF 900/OF 1010 copying rings

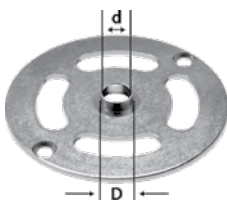
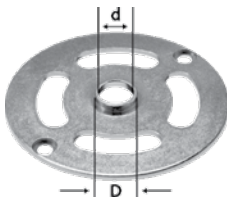
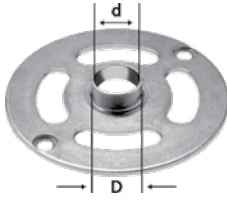
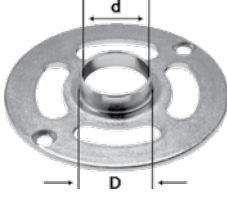

	D mm	Dia. mm				
 <p>KR-D 10,8/OF 900 for OF 900, OF 1000, OF 1010, OF 1010 R, KF</p>	10,8	7,8	486029	1	11,90	1 206002
 <p>KR-D 13,8/OF 900 for OF 900, OF 1000, OF 1010, OF 1010 R, KF</p>	13,8	10,8	484176	1	11,90	1 206002
 <p>KR-D 17/OF 900 for OF 900, OF 1000, OF 1010, OF 1010 R, KF</p>	17	14	486030	1	11,90	1 206002
 <p>KR-D 24/OF 900 for OF 900, OF 1000, OF 1010, OF 1010 R, KF</p>	24	21	486031	1	11,90	1 206002

* Attention: Festool products with Bluetooth® technology are not available in all countries.
For more information, please contact the official local Festool import partner.
You can find the overview regarding our products and our partners worldwide on our website www.festool.com

PU = Packaging Units
SU = Shipping Units

¹⁾ Manufacturer's recommended retail price.
Dealer prices may vary.

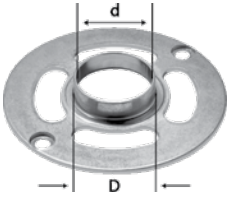
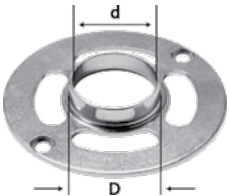
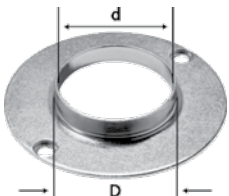
Routing

Denomination and application		Order no.	PU	Trade price € excl. VAT		SU	DG		
				per PU ¹⁾					
	KR-D 27/OF 900 for OF 900, OF 1000, OF 1010, OF 1010 R, KF	27	24	486032	1	11,90	1	206002	
		KR-D 30/OF 900 for OF 900, OF 1000, OF 1010, OF 1010 R, KF	30	27	486033	1	11,90	1	206002
			KR-D 40/OF 900 for OF 900, OF 1000, OF 1010, OF 1010 R, KF	40	37	486034	1	11,90	1
	ZD-OF/D 6,35+8 for all Festool routers; for shank support Ø 6.35 mm and 8 mm for centering the copying rings		-	-	492187	1	24,50	1	206002

Copying rings OF 1400

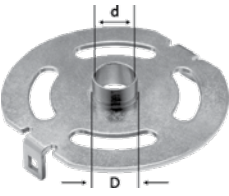
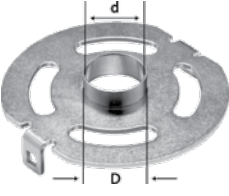
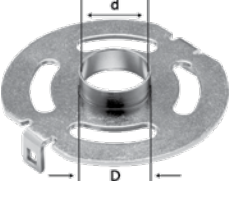
		D mm	Dia. mm						
	KR-D 17,0/OF 1400 for OF 1400	17	14	493315	1	19,30	1	206002	
		KR-D 24,0/OF 1400 for OF 1400	24	21	492183	1	19,60	1	206002
			KR-D 27,0/OF 1400 for OF 1400	27	24	492184	1	19,60	1

* Attention: Festool products with Bluetooth® technology are not available in all countries.
 For more information, please contact the official local Festool import partner.
 You can find the overview regarding our products and our partners worldwide on our website www.festool.com

PU = Packaging Units
 SU = Shipping Units

¹⁾ Manufacturer's recommended retail price.
 Dealer prices may vary.

Routing

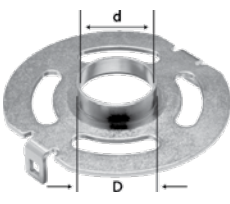
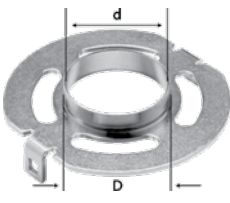
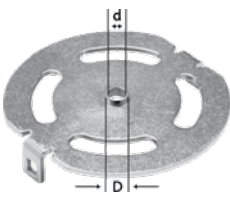
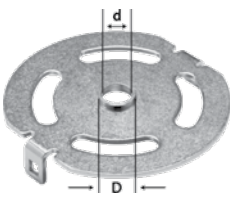
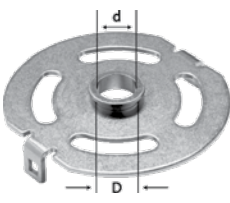
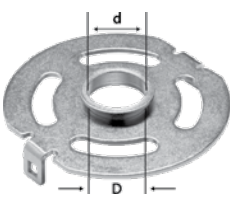
Denomination and application	Order no.	PU	Trade price			SU	DG
			€ excl. VAT	per PU ¹⁾			
 <p>KR-D 30,0/OF 1400 for OF 1400</p>	30	27	492185	1	19,60	1	206002
 <p>KR-D 40,0/OF 1400 for OF 1400</p>	40	37	492186	1	19,60	1	206002
 <p>KR-D 8,5/OF 1400 for OF 1400 / VS 600</p>	8,5	6,5	492179	1	19,60	1	206002
 <p>KR-D 13,8/OF 1400 for OF 1400 / VS 600</p>	13,8	10,8	492180	1	19,60	1	206002
 <p>KR-D 17,0/OF 1400 for OF 1400 / VS 600</p>	17	14	492181	1	19,60	1	206002
 <p>KR-D 24,0/OF 1400 for OF 1400 / VS 600</p>	24	21	492182	1	19,60	1	206002

* Attention: Festool products with Bluetooth® technology are not available in all countries.
For more information, please contact the official local Festool import partner.
You can find the overview regarding our products and our partners worldwide on our website www.festool.com

PU = Packaging Units
SU = Shipping Units

¹⁾ Manufacturer's recommended retail price.
Dealer prices may vary.

Copying rings OF 2200

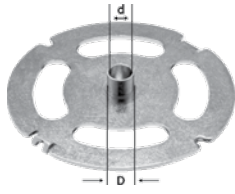

KR-D 12,7/OF 2200
for OF 2200

D mm	Dia. mm	Order no.	PU	Trade price € excl. VAT per PU ¹⁾	SU	DG
------	---------	-----------	----	--	----	----

12,7	10	495339	1	18,60	1	206002
------	----	--------	---	-------	---	--------

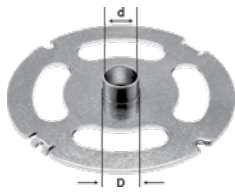

KR-D 17,0/OF 2200
for OF 2200

17	15	494622	1	18,60	1	206002
----	----	--------	---	-------	---	--------

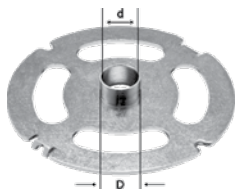

KR-D 19,05/OF 2200
for OF 2200

19,05	17	495340	1	18,60	1	206002
-------	----	--------	---	-------	---	--------

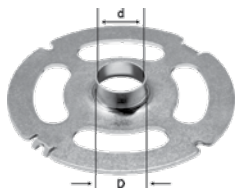

KR-D 24,0/OF 2200
for OF 2200

24	22	494623	1	18,60	1	206002
----	----	--------	---	-------	---	--------

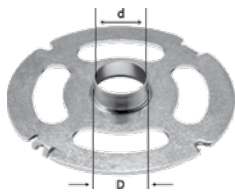

KR-D 25,4/OF 2200
for OF 2200

25,4	23	495341	1	18,60	1	206002
------	----	--------	---	-------	---	--------

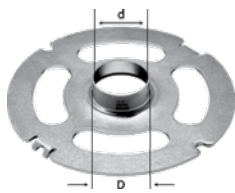

KR-D 27,0/OF 2200
for OF 2200

27	24	494624	1	18,60	1	206002
----	----	--------	---	-------	---	--------

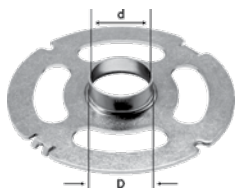

KR-D 30,0/OF 2200
for OF 2200

30	27	494625	1	18,60	1	206002
----	----	--------	---	-------	---	--------

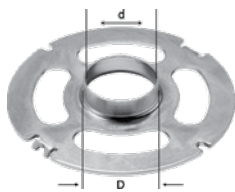

KR-D 34,93/OF 2200
for OF 2200



34,93	32	495342	1	18,60	1	206002
-------	----	--------	---	-------	---	--------

* Attention: Festool products with Bluetooth® technology are not available in all countries.
For more information, please contact the official local Festool import partner.
You can find the overview regarding our products and our partners worldwide on our website www.festool.com

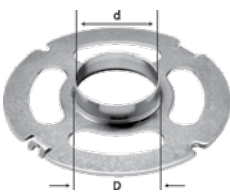

PU = Packaging Units
SU = Shipping Units

¹⁾ Manufacturer's recommended retail price.
Dealer prices may vary.

Routing



Denomination and application	Order no.	PU	Trade price			SU	DG
			€ excl. VAT	per PU ¹⁾			
 KR-D 40,0/OF 2200 for OF 2200	40	37	494626	1	18,60	1	206002
 KRA-ZOLL/OF 2200 for OF 2200; adapter for imperial copying rings	-	-	494627	1	12,80	1	206002

Collets

 SZ-D 6/OF 1000 for MFK/OFK 700, OF 900, OF 1000, OF 1010, KF; with locking nut; for cutter shank Ø 6 mm	488760	1	48,40	1	206002	
	SZ-D 6,35/OF 1000 for MFK/OFK 700, OF 900, OF 1000, OF 1010, KF; with locking nut; for cutter shank Ø 6.35 mm (1/4")	488761	1	48,40	1	206002
	SZ-D 8/OF 1000 for MFK/OFK 700, OF 900, OF 1000, OF 1010, KF; with locking nut; for router shank Ø 8 mm	488755	1	48,40	1	206002
 SZ-D 6/OF 1000 for MFK/OFK 700, OF 900, OF 1000, OF 1010, KF; with locking nut; for cutter shank Ø 6 mm	488760	1	48,40	1	206002	
	SZ-D 6,35/OF 1000 for MFK/OFK 700, OF 900, OF 1000, OF 1010, KF; with locking nut; for cutter shank Ø 6.35 mm (1/4")	488761	1	48,40	1	206002
	SZ-D 8/OF 1000 for MFK/OFK 700, OF 900, OF 1000, OF 1010, KF; with locking nut; for router shank Ø 8 mm	488755	1	48,40	1	206002

Special clamping collets

for use with OF 1400/2200/2000 fork wrench size 24 necessary (772051) (after 2008)

 SZ-D 6,0/OF 1400/2000/2200 for the OF 1400, OF 2000, OF 2200; for cutter shank Ø 6 mm	494459	1	57,00	1	206002	
	SZ-D 6,35/OF 1400/2000/2200 for the OF 1400, OF 2000, OF 2200; for router shaft 6.35 mm	494463	1	57,00	1	206002
	SZ-D 8,0/OF 1400/2000/2200 for the OF 1400, OF 2000, OF 2200; for router shaft Ø 8 mm	494460	1	57,00	1	206002
	SZ-D 9,53/OF 1400/2000/2200 for the OF 1400, OF 2000, OF 2200; for router shaft 9.53 mm	494464	1	57,00	1	206002
	SZ-D 10,0/OF 1400/2000/2200 for the OF 1400, OF 2000, OF 2200; for cutter shank Ø 10 mm	494461	1	57,00	1	206002
	SZ-D 12,0/OF 1400/2000/2200 for the OF 1400, OF 2000, OF 2200; for cutter shank Ø 12 mm	494462	1	57,00	1	206002
	SZ-D 12,7/OF 1400/2000/2200 for the OF 1400, OF 2000, OF 2200; for router shaft Ø 12.7 mm	494465	1	57,00	1	206002
 SZ-D 6,0/OF 1400/2000/2200 for the OF 1400, OF 2000, OF 2200; for cutter shank Ø 6 mm	494459	1	57,00	1	206002	
	SZ-D 6,35/OF 1400/2000/2200 for the OF 1400, OF 2000, OF 2200; for router shaft 6.35 mm	494463	1	57,00	1	206002
	SZ-D 8,0/OF 1400/2000/2200 for the OF 1400, OF 2000, OF 2200; for router shaft Ø 8 mm	494460	1	57,00	1	206002
	SZ-D 9,53/OF 1400/2000/2200 for the OF 1400, OF 2000, OF 2200; for router shaft 9.53 mm	494464	1	57,00	1	206002
	SZ-D 10,0/OF 1400/2000/2200 for the OF 1400, OF 2000, OF 2200; for cutter shank Ø 10 mm	494461	1	57,00	1	206002

* Attention: Festool products with Bluetooth® technology are not available in all countries.
 For more information, please contact the official local Festool import partner.
 You can find the overview regarding our products and our partners worldwide on our website www.festool.com





PU = Packaging Units
 SU = Shipping Units

¹⁾ Manufacturer's recommended retail price.
 Dealer prices may vary.



Routing

Denomination and application	Order no.	PU	Trade price		
			€ excl. VAT	SU	DG
 <p>SZ-D 12,0/OF 1400/2000/2200 for the OF 1400, OF 2000, OF 2200; for cutter shank Ø 12 mm</p>	494462	1	57,00	1	206002
	494465	1	57,00	1	206002

Edge trimming

 <p>Angle arm, WA-OF for OF 900, OF 1000, OF 1010, OF 1010 R, OF 1400, KF; needed to copy workpieces in conjunction with the copier scanning set KT-OF</p>	486052	1	40,10	1	206002
	 <p>Copier scanning set, KT-OF for OF 900, OF 1000, OF 1010, OF 1010 R, OF 1400, KF; copier scanning set KT-OF and angle arm WA-OF are needed to copy workpieces</p>	486534	1	81,40	1
 <p>Edging plate, UP-OF for OF 900, OF 1000, OF 1010, OF 1010 R, KF; angle arm WA-OF and edging plate UP-OF are needed for the flush trimming of projected edges</p>	486058	1	66,60	1	206002
 <p>Chip guard, SF-OF for OF 900, OF 1000, OF 1010, OF 1010 R, KF</p>	486242	1	35,80	1	206002

Routing template

 <p>Routing template, MFS 400 for all routers with copying ring; for rectangular (300 x 100 mm) or curved (Ø 600 mm) cut-outs; 2 x angle stop, tilt protection, circle routing insert, Screwdriver dimensions length x width 300 x 100 mm; curves 40 - 300 mm</p>	492610	1	264,90	1	206005
	 <p>Routing template, MFS 700 for all routers with copying ring; for rectangular (max. 600 x 300 mm) or curved (max. Ø 1200 mm) cut-outs; 2 x angle stop, tilt protection, circle routing insert, Screwdriver dimensions length x width 600 x 300 mm; curves 40 - 600 mm</p>	492611	1	414,40	1
 <p>Extension profile, MFS-VP 200 for extension of MFS 400, MFS 700; with scale; 2 x profile 200 mm, longitudinal connectors, screwdriver, WAF 2.5</p>	492722	2	98,50	1	206005
<p>Extension profile, MFS-VP 400 for extension of MFS 400, MFS 700; with scale; 2 x 400 mm profile, longitudinal connectors, screwdriver, WAF 2.5</p>	492723	2	115,30	1	206005
<p>Extension profile, MFS-VP 700 for extension of MFS 400, MFS 700; with scale; 2 x profile 700 mm, longitudinal connectors, screwdriver, WAF 2.5</p>	492724	2	203,50	1	206005
<p>Extension profile, MFS-VP 1000 for extension of MFS 400, MFS 700; with scale; 2 x profile 1000 mm, longitudinal connectors, screwdriver, WAF 2.5</p>	492725	2	241,90	1	206005

Routing

Denomination and application		Order no.	PU	Trade price € excl. VAT per PU ¹⁾	SU	DG
	Extension profile, MFS-VP 2000 for extension of MFS 400, MFS 700; without scale; 2 x profile 2000 mm, longitudinal connectors, screwdriver, WAF 2.5	492726	2	300,20	1	206005
	Router carriage, MFS-FS for large-surface routing; for MFS 400, MFS 700 traverse path 600 mm; copy ring dia. 30 mm	495648	1	148,80	1	206005
Worktop template						
	Worktop template, APS 900/2 for corner and panel connectors with depths of up to 900 mm; for diameter of cutter 14 mm and copying ring 30 mm; corner connection template, profile MFS-VP 1000 (492725), 3 x Bolt, Screwdriver panel depth with corner joints, with adjustment 900 mm; for worktop connectors, bolt length 65/150 mm; panel depth with corner joints, without adjustment 600/650 mm; dimensions (L x W x H) 1000 x 380 x 16 mm	204219	1	367,00	1	206005
Hole drilling system						
	Hole drilling set, LR 32-SYS for OF 900, OF 1000, OF 1010, OF 1400; for use with hole line guide rails; guide plate, centring mandrel, hinge location cutter HM Ø 35 mm, dowel drill HW Ø 5 mm (V-shaped tip), dowel drill HM Ø 5 mm (with centring bit and pre-cutter), 2 parallel side fences with adjustable stop, FSZ 120 fastening clamps (two units) (489570), 2 x Longitudinal stop, screwdriver, WAF 5, Systainer SYS 1 T-LOC (497563) Hole spacing 32 mm; Length of series of holes (without guide extension) 1400 / 2424; side stop setting range 0 - 110 mm; Product weight 0,9 kg	584100	1	472,50	1	206003
	Hole drilling set, LR 32 Set for routers OF 900, OF 1000, OF 1010, OF 1400 in the FS-LR32 hole drilling system; for use with hole line guide rails; guide plate, centring mandrel, 2 x side stop, 2 x Longitudinal stop	583290	1	241,30	1	206003
	Guide plate, FP-LR 32 for routers OF 900, OF 1000, OF 1010, OF 1400 in the FS-LR32 hole drilling system; centring mandrel	494340	1	136,70	1	206003
	Parallel side fence, SA-LR 32 with adjustable stop; for parallel alignment of guide rails	485758	1	68,80	1	206003
	Adjustable stop, AR-LR 32 for OF 900, OF 1000, OF 1010, OF 1400; for parallel side fence	485759	1	26,50	1	206011
	Guide rail, FS 1400/2-LR 32 length 1400 mm	496939	1	120,30	1	206003
	Guide rail, FS 2424/2-LR 32 length 2424 mm	491622	1	293,00	1	206003
	Stopper, LA-LR 32 FS positions the first hole on the hole series guide rail at a distance of 9.5, 16 or 32 mm from the workpiece edge	496938	2	42,40	1	206003

* Attention: Festool products with Bluetooth® technology are not available in all countries.
For more information, please contact the official local Festool import partner.
You can find the overview regarding our products and our partners worldwide on our website www.festool.com

PU = Packaging Units
SU = Shipping Units

¹⁾ Manufacturer's recommended retail price.
Dealer prices may vary.

Denomination and application	Order no.	PU	Trade price		
			€ excl. VAT	SU	DG

Joining system

Joining system VS 600



Joining system, VS 600 GE

for OF 900, OF 1000, OF 1010, OF 1400
workpiece thickness (depending on joint) 6 - 29 mm; max. workpiece width 600 mm

488876	1	445,10	1	206001
--------	---	--------	---	--------

Accessories for VS 600

Accessories for VS 600



Dovetail joint template, VS 600 SZ 14

for OF 1010, OF 1400; for blind dovetail joints, tenon size 14 mm; copying rings for the OF 1400 must be ordered separately; copying ring \varnothing 17 mm (for OF 1010) [490770]
workpiece thickness 14 - 20 mm

488877	1	86,00	1	206001
--------	---	-------	---	--------

Dovetail joint template, VS 600 SZ 20

for OF 1010, OF 1400; for blind dovetail joints, tenon size 20 mm; copying rings for the OF 1400 must be ordered separately; copying ring \varnothing 24 mm (for OF 1010) [490771]
workpiece thickness 21 - 28 mm

488878	1	86,00	1	206001
--------	---	-------	---	--------

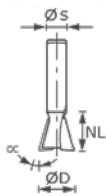

Dovetail cutter, HS S8 D13,8/13,5/15°

for semi-covered dovetail joints SZ 14
D 13,8 mm; NL 13,5 mm; GL 46 mm; alpha 15°; s 8 mm

490991	1	22,40	1	506001
--------	---	-------	---	--------

Dovetail cutter, HW S8 D13,8/13,5/15°

for semi-covered dovetail joints SZ 14
D 13,8 mm; NL 13,5 mm; GL 46 mm; alpha 15°; s 8 mm

490992	1	39,10	1	506001
--------	---	-------	---	--------

Dovetail cutter, HS S8 D20/17/15°

for semi-covered dovetail joints SZ 20
D 20 mm; NL 17 mm; GL 49 mm; alpha 15°; s 8 mm

490995	1	33,50	1	506001
--------	---	-------	---	--------

Dovetail cutter, HW S8 D20/17/15°

for semi-covered dovetail joints SZ 20
D 20 mm; NL 17 mm; GL 49 mm; alpha 15°; s 8 mm

490996	1	44,30	1	506001
--------	---	-------	---	--------

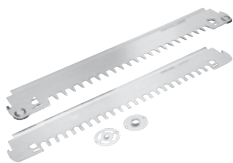

Template-kit, VS 600 SZO 14

for OF 1010, OF 1400; open dovetail joint, slot size 14 mm; copying rings for the OF 1400 must be ordered separately; copying ring \varnothing 8.5 mm (for OF 1010) [490772], copying ring \varnothing 17 mm (for OF 1010) [490770]
workpiece thickness 10 - 14 mm

491152	1	148,00	1	206001
--------	---	--------	---	--------

Template-kit, VS 600 SZO 20

for OF 1010, OF 1400; for exposed dovetail joints, tenon size 20 mm; copying rings for the OF 1400 must be ordered separately; copying ring \varnothing 13.8 mm (for OF 1010) [484176], copying ring \varnothing 24 mm (for OF 1010) [490771]
workpiece thickness 14 - 25 mm

491153	1	148,00	1	206001
--------	---	--------	---	--------

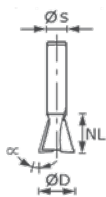

Dovetail cutter, HW S8 D14,3/16/10°

for open dovetail joints SZO 14
D 14,3 mm; NL 16 mm; GL 50 mm; alpha 10°; s 8 mm

491164	1	40,80	1	506001
--------	---	-------	---	--------

Dovetail cutter, HW S8 D20/26/10°

for open dovetail joint slots, SZO 20
D 20 mm; NL 26 mm; GL 58 mm; alpha 10°; s 8 mm

491165	1	47,40	1	506001
--------	---	-------	---	--------

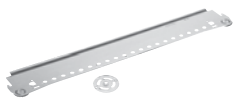

Jointing system dowel joint unit, VS 600 DS 32

for OF 1010, OF 1400; dowelling joint in the 32 grid; copying rings for the OF 1400 must be ordered separately; copying ring \varnothing 13.8 mm (for OF 1010) [484176]

488881	1	86,00	1	206001
--------	---	-------	---	--------

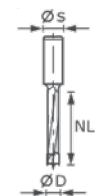

Dowel drill, HW S8 D6/30 Z

with brad point
D 6 mm; NL 30 mm; GL 53,5 mm; s 8 mm

491067	1	25,90	1	506001
--------	---	-------	---	--------

Dowel drill, HW S8 D8/30 Z

with brad point
D 8 mm; NL 30 mm; GL 53,5 mm; s 8 mm

491068	1	27,10	1	506001
--------	---	-------	---	--------

Dowel drill, HW S8 D10/30 Z

with brad point
D 10 mm; NL 30 mm; GL 53,5 mm; s 8 mm

491069	1	29,90	1	506001
--------	---	-------	---	--------



Slot joint template, VS 600 FZ 6

for OF 1010, OF 1400; for slot joint connections, tenon size 6 mm; copying rings for the OF 1400 must be ordered separately; copying ring \varnothing 8.5 mm (for OF 1010) [490772]
workpiece thickness 6 - 10 mm

488879	1	77,00	1	206001
--------	---	-------	---	--------

* Attention: Festool products with Bluetooth® technology are not available in all countries.

For more information, please contact the official local Festool import partner. You can find the overview regarding our products and our partners worldwide on our website www.festool.com

PU = Packaging Units
SU = Shipping Units

¹⁾ Manufacturer's recommended retail price. Dealer prices may vary.

Routing

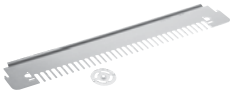
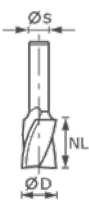
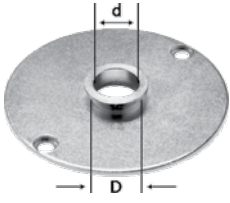
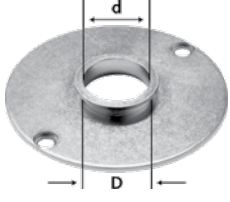
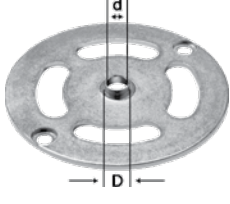
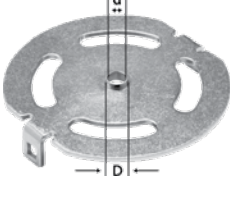
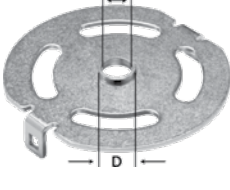
Denomination and application	Order no.	PU	Trade price € excl. VAT per PU ¹⁾	SU	DG
 <p>Slot joint template, VS 600 FZ 10 for OF 1010, OF 1400; for slot joint connections, tenon size 10 mm; copying rings for the OF 1400 must be ordered separately; copying ring Ø 13.8 mm (for OF 1010) (484176) workpiece thickness 10 - 20 mm</p>	488880	1	77,00	1	206001
 <p>Spiral groove cutter, HS Spi S8 D6/21 for slot joints FZ 6 and open dovetail joints SZO 14 with fine precision in diameter D 6 mm; NL 21 mm; GL 50 mm; s 8 mm</p>	490944	1	25,90	1	506001
<p>Spiral groove cutter, HW Spi S8 D6/21 for slot joints FZ 6 and open dovetail joints SZO 14 with fine precision in diameter D 6 mm; NL 21 mm; GL 50 mm; s 8 mm</p>	490978	1	53,10	1	506001
<p>Spiral groove cutter, HS Spi S8 D10/30 for slot joints FZ 10 and open dovetail joints SZO 20 with fine precision in diameter D 10 mm; NL 30 mm; GL 60 mm; s 8 mm</p>	490946	1	29,90	1	506001
<p>Spiral groove cutter, HW Spi S8 D10/30 for slot joints FZ 10 and open dovetail joints SZO 20 with fine precision in diameter D 10 mm; NL 30 mm; GL 60 mm; s 8 mm</p>	490980	1	65,70	1	506001
 <p>Copying ring, KR D17/V5 600-SZ 14 for OF 1010 D 17 mm</p>	490770	1	12,90	1	206001
 <p>Copying ring, KR D24/V5 600-SZ 20 for OF 1010 D 24 mm</p>	490771	1	12,90	1	206001
 <p>Copying ring, KR D8,5/V5 600-FZ 6 for OF 1010 D 8,5 mm</p>	490772	1	12,90	1	206001
 <p>Copying ring, KR-D 8,5/OF 1400 for OF 1400 / VS 600 D 8,5 mm; dia. 6,5 mm</p>	492179	1	19,60	1	206002
 <p>Copying ring, KR-D 13,8/OF 1400 for OF 1400 / VS 600 D 13,8 mm; dia. 10,8 mm</p>	492180	1	19,60	1	206002

* Attention: Festool products with Bluetooth® technology are not available in all countries.
For more information, please contact the official local Festool import partner.
You can find the overview regarding our products and our partners worldwide on our website www.festool.com

PU = Packaging Units
SU = Shipping Units

¹⁾ Manufacturer's recommended retail price.
Dealer prices may vary.

Routing

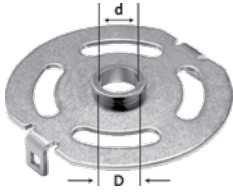
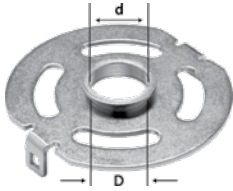
Denomination and application	Order no.	PU	Trade price € excl. VAT per PU ¹⁾	SU	DG
 <p>Copying ring, KR-D 17,0/OF 1400 for OF 1400 / VS 600 D 17 mm; dia. 14 mm</p>	492181	1	19,60	1	206002
 <p>Copying ring, KR-D 24,0/OF 1400 for OF 1400 / VS 600 D 24 mm; dia. 21 mm</p>	492182	1	19,60	1	206002

Routing tools

Router cutter HW, solid hard metal with base blade									
	D mm	NL mm	GL mm	s mm					
 HW S8 D3/6	3	6	45	8	490952	1	32,00	1	506001
HW S8 D4/10	4	10	45	8	490953	1	32,00	1	506001
HW S8 D5/12	5	12	45	8	490954	1	32,70	1	506001
HW S8 D6/14	6	14	55	8	490955	1	33,30	1	506001
HW S8 D7/17	7	17	55	8	490956	1	35,20	1	506001
HW S8 D8/20	8	20	55	8	490957	1	36,00	1	506001
HW S8 D8/30	8	30	60	8	491647	1	41,20	1	506001

Router cutter HW with fitted base blade									
	D mm	NL mm	GL mm	s mm					
 HW S8 D9/23	9	23	55	8	490958	1	30,20	1	506001
HW S8 D10/20	10	20	60	8	490959	1	30,50	1	506001
HW S8 D10/25	10	25	60	8	490960	1	33,00	1	506001
HW S8 D10/30	10	30	60	8	491648	1	35,70	1	506001
HW S8 D11/20	11	20	60	8	490961	1	33,50	1	506001
HW S8 D12/20	12	20	60	8	490962	1	34,50	1	506001
HW S8 D12/30	12	30	60	8	491649	1	37,80	1	506001
HW S8 D13/20	13	20	60	8	490963	1	36,00	1	506001
HW S8 D14/20	14	20	60	8	490964	1	36,70	1	506001
HW S8 D15/20	15	20	60	8	490965	1	39,10	1	506001
HW S8 D16/20	16	20	60	8	490966	1	43,10	1	506001
HW S8 D16/30	16	30	65	8	490967	1	43,90	1	506001
HW S8 D18/20	18	20	60	8	490968	1	45,70	1	506001
HW S8 D18/30	18	30	65	8	490969	1	46,30	1	506001
HW S8 D19/20	19	20	60	8	490970	1	46,90	1	506001
HW S8 D20/20	20	20	60	8	490971	1	47,10	1	506001

* Attention: Festool products with Bluetooth® technology are not available in all countries.
For more information, please contact the official local Festool import partner.
You can find the overview regarding our products and our partners worldwide on our website www.festool.com

PU = Packaging Units
SU = Shipping Units

¹⁾ Manufacturer's recommended retail price.
Dealer prices may vary.

Routing

Denomination and application

Order no. PU Trade price € excl. VAT per PU ¹⁾ SU DG



	D mm	NL mm	GL mm	s mm					
HW S8 D20/30	20	30	65	8	490972	1	48,40	1	506001
HW S8 D22/20	22	20	60	8	490973	1	50,30	1	506001
HW S8 D24/20	24	20	60	8	490974	1	53,30	1	506001
HW S8 D25/20	25	20	60	8	490975	1	59,10	1	506001
HW S8 D30/20	30	20	60	8	490976	1	65,70	1	506001

Router cutter HW with fitted base blade



	D mm	NL mm	GL mm	s mm					
HW S12 D10/35	10	35	90	12	491086	1	58,50	1	506001
HW S12 D12/40	12	40	90	12	491087	1	61,00	1	506001
HW S12 D13,2/35 PLANET for automatic door seal, "PLANET"	13,2	35	85	12	493789	1	77,30	1	506001
HW S12 D14/40	14	40	85	12	491088	1	72,10	1	506001
HW S12 D14/50	14	50	100	12	491089	1	92,30	1	506001
HW S12 D15/35 SCHALL-EX for automatic door seal, "SCHALL-EX"	15	35	85	12	493790	1	86,80	1	506001
HW S12 D16/45	16	45	90	12	491090	1	74,50	1	506001
HW S12 D16/60	16	60	100	12	491091	1	94,90	1	506001
HW S12 D18/45	18	45	90	12	491092	1	79,90	1	506001
HW S12 D20/45	20	45	90	12	491093	1	84,00	1	506001
HW S12 D22/45	22	45	90	12	491094	1	90,30	1	506001
HW S12 D24/45	24	45	90	12	491095	1	94,90	1	506001
HW S12 D30/35	30	35	90	12	491096	1	127,00	1	506001

Router cutter HS single-edged, with base blade

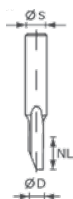

	D mm	NL mm	GL mm	s mm					
HS S8 D 3/8	3	8	45	8	490941	1	15,80	1	506001
HS S8 D 4/15	4	15	48	8	490942	1	15,80	1	506001
HS S8 D 5/12	5	12	50	8	490943	1	15,80	1	506001

Spiral router cutter HS with base blade

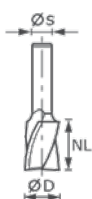

	D mm	NL mm	GL mm	s mm					
HS Spi S8 D6/21 for slot joints FZ 6 and open dovetail joints SZO 14 with fine precision in diameter	6	21	50	8	490944	1	25,90	1	506001
HS Spi S8 D8/19	8	19	50	8	490945	1	19,90	1	506001
HS Spi S8 D10/30 for slot joints FZ 10 and open dovetail joints SZO 20 with fine precision in diameter	10	30	60	8	490946	1	29,90	1	506001
HS Spi S8 D12/20	12	20	52	8	490947	1	24,50	1	506001
HS Spi S8 D14/20	14	20	52	8	490948	1	27,10	1	506001
HS Spi S8 D16/20	16	20	52	8	490949	1	29,90	1	506001

* Attention: Festool products with Bluetooth® technology are not available in all countries.
For more information, please contact the official local Festool import partner.
You can find the overview regarding our products and our partners worldwide on our website www.festool.com

PU = Packaging Units
SU = Shipping Units

¹⁾ Manufacturer's recommended retail price.
Dealer prices may vary.

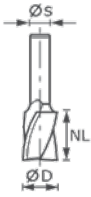
Denomination and application	Order no.	PU	Trade price			SU	DG		
			€ excl. VAT	per PU ¹⁾					
	D mm	NL mm	GL mm	s mm					
HS Spi S8 D18/25	18	25	57	8	490950	1	34,50	1	506001
HS Spi S8 D20/25	20	25	57	8	490951	1	37,20	1	506001



Spiral router cutter HW solid hard metal with base blade

	D mm	NL mm	GL mm	s mm	Trade price				
					€ excl. VAT	per PU ¹⁾	SU	DG	
									
HW Spi S8 D4/10	4	10	45	8	490977	1	50,40	1	506001
HW Spi S8 D6/21 for slot joints FZ 6 and open dovetail joints SZO 14 with fine precision in diameter	6	21	50	8	490978	1	53,10	1	506001
HW Spi S8 D8/25	8	25	55	8	490979	1	56,20	1	506001
HW Spi S8 D10/30 for slot joints FZ 10 and open dovetail joints SZO 20 with fine precision in diameter	10	30	60	8	490980	1	65,70	1	506001

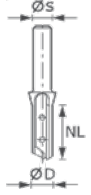



Turning plate router cutter HW single-edged, with base blade

	D mm	NL mm	GL mm	s mm	Trade price				
					€ excl. VAT	per PU ¹⁾	SU	DG	
									
HW S8 D8/20 WP Z1	8	20	50	8	491078	1	101,70	1	506001
HW S8 D10/25 WP Z1	10	25	55	8	491079	1	103,10	1	506001
HW S8 D12/30 WP Z1	12	30	61	8	491080	1	106,10	1	506001
HW D14/30 S8	14	30	66	8	492715	1	119,90	1	506001
HW D16/30 S8	16	30	70	8	492716	1	117,10	1	506001
HW D18/30 S8	18	30	70	8	492717	1	123,60	1	506001

Accessories for turning plate router cutter HW, single-edged with base blade

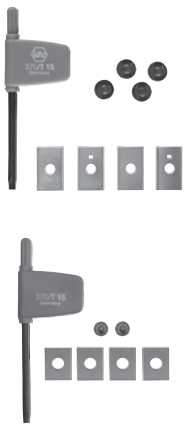
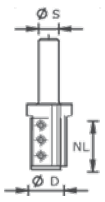
	Replacement blade for cutter, HW-WP 20x4,1x1,1 (4x) for cutter 491078; T8 TX spanner, 2 x sink screw, 4 x reversible blade	491386	1	48,40	1	506003
	Replacement blade for cutter, HW-WP 25x5,5x1,1 (4x) for cutter 491079 (4 pcs); T8 TX spanner, 2 x sink screw, 4 x reversible blade	491387	1	51,00	1	506003
	Replacement blade for cutter, HW-WP 30x5,5x1,1 (4x) for cutters 491080, 492715; T8 TX spanner, 2 x sink screw, 4 x reversible blade	491388	1	53,60	1	506003

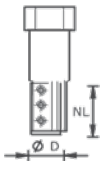
Routing

Denomination and application		Order no.	PU	Trade price € excl. VAT per PU ¹⁾	SU	DG			
	Reversible blade, HW-WP 30x12x1,5 (4x) for 492716, 492717, 491120 cutters; main plate; 4 x oval head screw, T15 TX spanner, 4 x reversible blade	491393	1	65,70	1	506003			
	Replacement blade for cutter, HW-WP 7,6x12x1,5 (4x) oval head screw, T15 TX spanner, 4 x reversible blade	491390	1	44,30	1	506003			
Turning plate router cutter HW single-edged, with base blade									
	HW S12 D16/50 WP	D mm	NL mm	GL mm	s mm				
		16	50	110	12	497454	1	205,80	1
Accessories for turning plate router cutter HW, single-edged with base blade									
	Wepla Set D 16 2+2 spare reversible blades set for cutter 497454; two reversible blades 50 x 12, two reversible blades 7.6 x 12, TX screws and TX spanners	497458	1	45,70	1	506001			
	Wepla Set D 16 2+2 spare reversible blades set for cutter 497454; two reversible blades 50 x 12, two reversible blades 7.6 x 12, TX screws and TX spanners	497458	1	45,70	1	506001			
Turning plate router cutter HW single-edged, with base blade									
direct bit holder									
	Groove cutter with reversible blades, HW KN D20/50 WP/K for OF 2200; extra long safety copying ring D30, 21 mm high, no. 497453, required for use of reversible blade cutters D 20 mm; NL 50 mm; GL 110 mm	497455	1	218,40	1	506001			
	Groove cutter with reversible blades, HW KN D24/50 WP/K for OF 2200; extra long safety copying ring D30, 21 mm high, no. 497453, required for use of reversible blade cutters D 24 mm; NL 50 mm; GL 117 mm	497456	1	228,10	1	506001			
	Accessories for turning plate router cutter HW, single-edged with base blade								
direct bit holder									
	Reversible blade, Wepla Set D 20 2+2 spare reversible blade set for cutter 497455; two reversible blades 50 x 12, two reversible blades 9 x 12, TX screws and TX spanners	497568	1	50,40	1	506001			

* Attention: Festool products with Bluetooth® technology are not available in all countries.
 For more information, please contact the official local Festool import partner.
 You can find the overview regarding our products and our partners worldwide on our website www.festool.com

PU = Packaging Units
 SU = Shipping Units

¹⁾ Manufacturer's recommended retail price.
 Dealer prices may vary.

Routing

Denomination and application	Order no.	PU	Trade price		
			€ excl. VAT	SU	DG



Reversible blade, Wepla Set D 24 2+2

spare reversible blades set for cutter 497456; two reversible blades 50 x 12, two 12 x 12 reversible blades, TX screws and TX spanners

497569	1	47,10	1	506001
--------	---	-------	---	--------

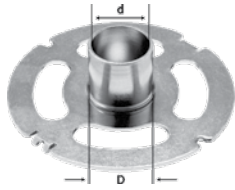

Copying ring, KR-D 30,0/21,5/OF 2200

for OF 2200; extra long safety copying ring D30, 21 mm high, required for use of reversible blade cutters 497455 and 497456
D 30 mm; dia. 27 mm

497453	1	32,80	1	206002
--------	---	-------	---	--------

Stepped cutter

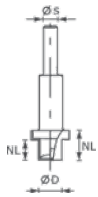

	D1 mm	D2 mm	NL mm	T1	s mm					
HW D16,3/12,3/9,3 S12	12,3	16,3	14	9,3	12	492713	1	97,80	1	506001
HW D20,3/12,3/9,3 S12	12,3	20,3	14	9,3	12	492714	1	103,00	1	506001

HW hand rail cutter

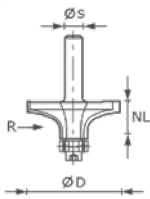

	D mm	NL mm	R mm	s mm						
HW R16/D64/26 S12 with ball bearing guide	64	26	16	12	492710	1	141,90	1	506001	

Hand rail cutter HW Profile

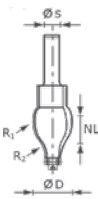

	D mm	NL mm	R1 mm	R2 mm	s mm					
HW R20.5/16/D32/57 S12 with ball bearing guide	32	57	20	16	12	492711	1	134,30	1	506001

Accessories for HW hand rail cutter

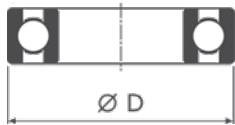

Ball bearing guide, D12,7 (2x)

hexagon socket screw diameter 12,7 mm

491383	2	14,20	1	506004
--------	---	-------	---	--------

* Attention: Festool products with Bluetooth® technology are not available in all countries.
For more information, please contact the official local Festool import partner.
You can find the overview regarding our products and our partners worldwide on our website www.festool.com

PU = Packaging Units
SU = Shipping Units

¹⁾ Manufacturer's recommended retail price.
Dealer prices may vary.

Routing

Denomination and application

Order no. PU Trade price
€ excl. VAT SU DG
per PU ¹⁾

Ogee cutter HW with ball bearing guide

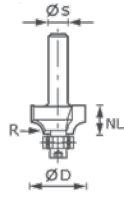

	D mm	NL mm	GL mm	R mm	s mm					
HW S8 D16,7/R2 KL	16,7	9	49	2	8	491009	1	54,30	1	506001
HW S8 D19,1/R3 KL	19,1	10	50	3	8	491010	1	55,10	1	506001
HW S8 D20,7/R4 KL	20,7	11	51	4	8	491011	1	55,70	1	506001
HW S8 D22,7/R5 KL	22,7	12	52	5	8	491012	1	56,20	1	506001
HW S8 D25,5/R6,35 KL	25,5	13,5	54	6,35	8	491013	1	57,60	1	506001
HW S8 D28,7/R8 KL	28,7	15	55	8	8	491014	1	59,80	1	506001
HW S8 D31,7/R9,5 KL	31,7	16,5	56	9,5	8	491015	1	62,10	1	506001
HW S8 D38,1/R12,7 KL	38,1	19	59	12,7	8	491016	1	68,40	1	506001
HW S8 D42,7/R15 KL	42,7	22	62	15	8	491017	1	72,30	1	506001

Ogee cutter HW with ball bearing guide

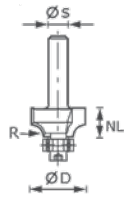

	D mm	NL mm	GL mm	R mm	s mm					
HW S12 D63/32/R25	63	32	82	25	12	491107	1	133,20	1	506001

Accessories for classic ogee cutter HW

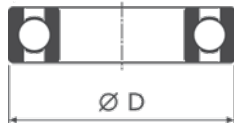

Ball bearing guide, D12,7 (2x) hexagon socket screw diameter 12,7 mm	491383	2	14,20	1	506004
Ball bearing guide, D9,53 (2x) hexagon socket screw diameter 9,53 mm	491382	2	25,40	1	506004

Half-round cutter HW with ball bearing guide

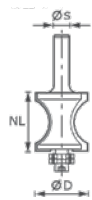

	D mm	NL mm	GL mm	R mm	s mm					
HW S8 D30/28	27	28	70	12	8	491139	1	78,90	1	506001

Accessories for half-round cutter HW

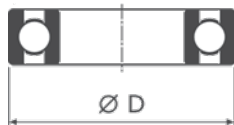

Ball bearing guide, D12,7 (2x) hexagon socket screw diameter 12,7 mm	491383	2	14,20	1	506004
---	--------	---	-------	---	--------

* Attention: Festool products with Bluetooth® technology are not available in all countries.
For more information, please contact the official local Festool import partner.
You can find the overview regarding our products and our partners worldwide on our website www.festool.com

PU = Packaging Units
SU = Shipping Units

¹⁾ Manufacturer's recommended retail price.
Dealer prices may vary.

Denomination and application

Order no. PU Trade price
€ excl. VAT SU DG
per PU ¹⁾

Ovolo edge cutter HW

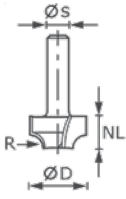

	D mm	NL mm	GL mm	R mm	s mm					
HW S8 D17/R3	17	10	40	3	8	491004	1	50,40	1	506001
HW S8 D23/R6	23	13	45	6	8	491007	1	56,20	1	506001

Ogee chamfer cutter HW with ball bearing guide

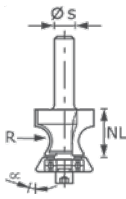

	D mm	NL mm	GL mm	R mm	Alpha °					
HW S8 D17,5/R6/15°	17,5	19	61	6	15	491134	1	78,50	1	506001
HW S8 D23,1/R6/30°	23,1	19	60	6	30	491135	1	83,00	1	506001

Accessories for classic ogee/chamfer cutter HW

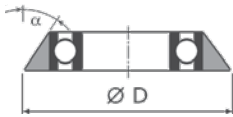

Ball bearing guide, D17,5/15° (2x) for cutter 491134; hexagon socket screw D 17,5 mm; alpha 15 °; min. diameter 17,5 mm	491403	2	36,20	1	506004
Ball bearing guide, D23,1/30° (2x) for cutter 491135; hexagon socket screw D 23,1 mm; alpha 30 °	491404	2	37,20	1	506004
Ball bearing guide, D31,4/45° (2x) for cutter 491136; hexagon socket screw D 31,4 mm; alpha 45 °	491405	2	40,30	1	506004



Chamfer cutter HW with ball bearing guide

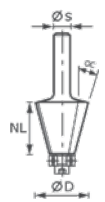

	D mm	NL mm	GL mm	Alpha °	s mm					
S8 HW 15° D18-KL OFK for OF 1010, OFK 700, MFK 700; optimised bearing mount suitable for 12.7 mm ball bearing guide or no ball bearing guide	18	11	50	15	8	499801	1	52,30	1	506001
HW S8 D25,7/25,7/15° Chamfer cutter 15° for edge trimming; with 12.7 mm ball bearing guide	25,7	25,1	70	15	8	491132	1	56,20	1	506001
S8 HW 30° D25-KL OFK for OF 1010, OFK 700, MFK 700; optimised bearing mount suitable for 12.7 mm ball bearing guide or no ball bearing guide	25	11	50	30	8	499800	1	53,20	1	506001

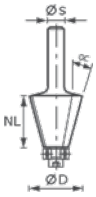

Routing

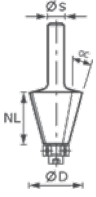
Denomination and application	D mm	NL mm	GL mm	Alpha °	s mm	Trade price				
						Order no.	PU	€ excl. VAT per PU ¹⁾	SU	DG
 <p>HW S8 D38,5/23/30° Chamfer cutter 30° for edge trimming; with 12.7 mm ball bearing guide</p>	38,5	25,7	64	30	8	491133	1	65,70	1	506001
 <p>S8 HW 45° D26-KL OFK for OF 1010, OFK 700, MFK 700; optimised bearing mount suitable for 12.7 mm ball bearing guide or no ball bearing guide</p>	26	7	48	45	8	499799	1	56,40	1	506001
 <p>HW S8 D36/45° Chamfer cutter 45° for edge trimming; with 12.7 mm ball bearing guide</p>	36	11,5	53	45	8	491025	1	52,40	1	506001

Chamfer cutter HW

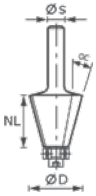
	D mm	NL mm	GL mm	Alpha °	s mm					
 <p>HW S12 D44/30/30°</p>	44	30	80	30	12	491101	1	81,40	1	506001
HW S12 D55/20/45°	55	20	76	45	12	491102	1	90,30	1	506001

Accessories for chamfer cutter HW

 <p>Ball bearing guide, D12,7 (2x) hexagon socket screw diameter 12,7 mm</p>	491383	2	14,20	1	506004
--	--------	---	-------	---	--------

Turning plate chamfer/edge-trimming cutter HW with ball bearing guide

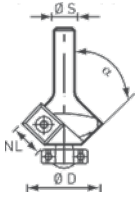
	D mm	NL mm	GL mm	Alpha °	s mm					
 <p>S8 HW 45° D27 12x12 KL for OF 1010, OFK 700, MFK 700; optimised bearing mount suitable for 12.7 mm ball bearing guide or no ball bearing guide; 12 x 12 mm reversible blade can be used 4 times</p>	27	8	55	45	8	499807	1	117,10	1	506001

* Attention: Festool products with Bluetooth® technology are not available in all countries. For more information, please contact the official local Festool import partner. You can find the overview regarding our products and our partners worldwide on our website www.festool.com

PU = Packaging Units
SU = Shipping Units

¹⁾ Manufacturer's recommended retail price. Dealer prices may vary.

Denomination and application

Order no. PU Trade price
€ excl. VAT SU DG
per PU ¹⁾

Accessories for turning plate chamfer/edge cutter

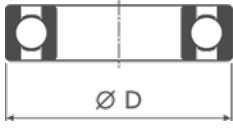

Ball bearing guide, D12,7 (2x)

hexagon socket screw
diameter 12,7 mm

491383 2 14,20 1 506004



Reversible blade, HW-WP 12x12x1,5 (4x)

2 x oval head screw, T15 TX spanner, 4 x reversible blade

491391 1 40,20 1 506003

Flute cutter HW

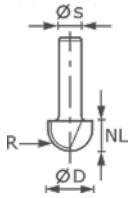

	D mm	NL mm	GL mm	R mm	s mm					
HW S8 R4	8	8	38	4	8	490983	1	31,20	1	506001
HW S8 R6,35	12,7	10	40	6,35	8	490984	1	35,20	1	506001
HW S8 R8	16	11	41	8	8	490985	1	39,10	1	506001
HW S8 R9,7	19,4	11	41	9,7	8	490986	1	42,40	1	506001
HW S8 R12,7	25,4	14	44	12,7	8	490987	1	47,60	1	506001

Flute cutter HW

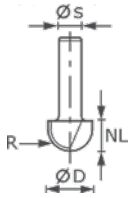

	D mm	NL mm	GL mm	R mm	s mm					
HW S12 D30/20/R15	30	20	60	15	12	491104	1	85,60	1	506001
HW S12 D40/25/R20	40	25	65	20	12	491105	1	101,70	1	506001

Flute cutter HW with ball bearing guide

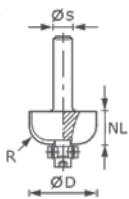

	D mm	NL mm	GL mm	R mm	s mm					
HW S8 D25,5/R6,35 KL	25,5	12,7	54	6,35	8	491018	1	48,40	1	506001
HW S8 D28,7/R8 KL	28,7	14	56	8	8	491019	1	52,10	1	506001
HW S8 D31,7/R9,5 KL	31,7	14,3	56	9,5	8	491020	1	55,10	1	506001
HW S8 D38,1/R12,7 KL	38,1	16	57	12,7	8	491021	1	63,10	1	506001

Accessories for flute cutter HW

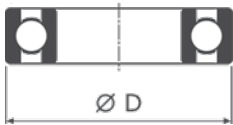

Ball bearing guide, D12,7 (2x)

hexagon socket screw
diameter 12,7 mm

491383 2 14,20 1 506004

Routing

Denomination and application

Order no. PU Trade price
€ excl. VAT SU DG
per PU ¹⁾

Water gutter cutter HW with ball bearing guide

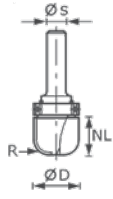

	D mm	NL mm	GL mm	R mm	s mm					
HW S8 R6,4 KL	19	16	53	6,4	8	490982	1	83,00	1	506001

Accessories for round nose cutter HW



Ball bearing guide, D19 (2x) diameter 19 mm						491396	2	21,70	1	506004
---	--	--	--	--	--	--------	---	-------	---	--------

Water gutter cutter HW

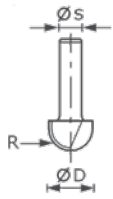

	D mm	NL mm	GL mm	R mm	s mm					
HW S8 R5	16	25	65	5	8	490981	1	69,60	1	506001

Edge trimming cutter HW with ball bearing guide

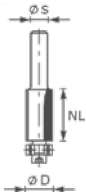

	D mm	NL mm	GL mm	Alpha °	s mm					
HW S8 D12,7/NL25 ball bearing, lower	12,7	25	65	0	8	491027	1	52,40	1	506001

Accessories for edge trimming cutter HW

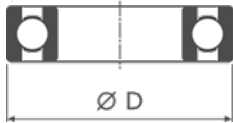

Ball bearing guide, D12,7 (2x) hexagon socket screw diameter 12,7 mm						491383	2	14,20	1	506004
---	--	--	--	--	--	--------	---	-------	---	--------

Edge trimming cutter HW with ball bearing guide

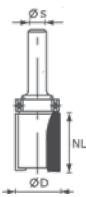





	D mm	NL mm	GL mm	Alpha °	s mm					
HW S8 D19/NL25 ball bearing, upper	19,05	25	62	0	8	491028	1	55,10	1	506001

* Attention: Festool products with Bluetooth® technology are not available in all countries.
For more information, please contact the official local Festool import partner.
You can find the overview regarding our products and our partners worldwide on our website www.festool.com

PU = Packaging Units
SU = Shipping Units

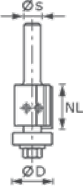
¹⁾ Manufacturer's recommended retail price.
Dealer prices may vary.

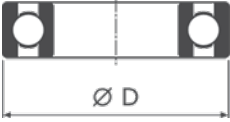
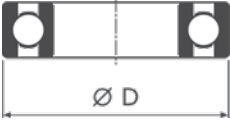
Routing

Denomination and application						Order no.	PU	Trade price € excl. VAT per PU ¹⁾	SU	DG					
Accessories for edge trimming cutter HW															
 Ball bearing guide, D19 (2x) diameter 19 mm						491396	2	21,70	1	506004					
Turning plate edge trimming cutter HW with ball bearing guide															
						D mm	NL mm	GL mm	Alpha °	s mm					
 HW S8 D19/20WM Z2						19	20	64	0	8	491082	1	108,60	1	506001
 S8 HW D19 12x12 KL OFK for OF 1010, OFK 700, MFK 700; optimised bearing mount suitable for 19 mm ball bearing guide or no ball bearing guide; 12 x 12 mm reversible blade can be used 4 times						19	12	52	0	8	499806	1	117,10	1	506001
Accessories for turning plate slot cutter HW															
 Reversible blade, HW-WP 12x12x1,5 (4x) 2 x oval head screw, T15 TX spanner, 4 x reversible blade						491391	1	40,20	1	506003					
 Ball bearing guide, D12,7 (2x) hexagon socket screw diameter 12,7 mm						491383	2	14,20	1	506004					
Accessories for turning plate slot cutter HW															
 Ball bearing guide, D19 (2x) nut M 6 diameter 19 mm						491385	2	20,20	1	506004					
 Reversible blade, HW-WP 20x12x1,5 (4x) 2 x oval head screw, T15 TX spanner, 4 x reversible blade						491392	1	40,20	1	506003					

Routing

Denomination and application

Order no. PU Trade price
€ excl. VAT SU DG
per PU ¹⁾

Chamfer/edge trimming cutter with ball bearing guide

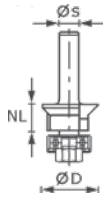

	D mm	NL mm	GL mm	s mm					
HW S8 D24/0° +45°	24	11	54	8	491026	1	41,10	1	506001

Accessories for edge trimming chamfer cutter

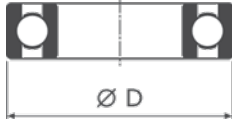

Ball bearing guide, D18 (2x) nut M 6 diameter 18 mm	491400	2	32,50	1	506004
--	--------	---	-------	---	--------

Drilling cutter HW



Drilling cutter, HW S8 D8/19 D 8 mm; NL 19 mm; GL 65 mm; s 8 mm	491037	1	28,40	1	506001
---	--------	---	-------	---	--------

Rebating cutter HW with ball bearing guide

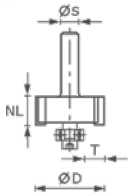

	D mm	NL mm	GL mm	T1	s mm					
HW S8 D31,7/NL 12,7	31,7	12,7	54	9,5	8	491022	1	50,40	1	506001

Accessories for rebating cutter HW

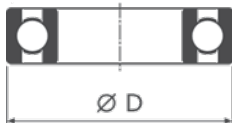

Ball bearing guide, D12,7 (2x) hexagon socket screw diameter 12,7 mm	491383	2	14,20	1	506004
Ball bearing guide, D9,5/12,7/16/19/22 hexagon socket screw diameter 9,5; 12,7; 16; 19; 22 mm	491406	1	57,20	1	506004

Turning plate rebating cutter with ball bearing guide

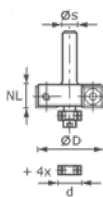

	D mm	NL mm	GL mm	s mm					
HW S8 D38/12	38	12	53,7	8	491085	1	101,70	1	506001

* Attention: Festool products with Bluetooth® technology are not available in all countries.
For more information, please contact the official local Festool import partner.
You can find the overview regarding our products and our partners worldwide on our website www.festool.com

PU = Packaging Units
SU = Shipping Units

¹⁾ Manufacturer's recommended retail price.
Dealer prices may vary.

Denomination and application

Order no. PU Trade price
€ excl. VAT SU DG
per PU ¹⁾

Accessories for turning plate rebating cutter

Reversible blade, HW-WP 12x12x1,5 (4x)

2 x oval head screw, T15 TX spanner, 4 x reversible blade

491391 1 40,20 1 506003



Ball bearing guide, D9,5/12,7/16/19/22

hexagon socket screw
diameter 9,5; 12,7; 16; 19; 22 mm

491406 1 57,20 1 506004

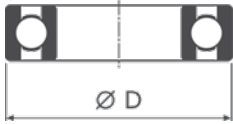

Dovetail cutter with pre-cutter

HW S8 D14,3/13,5/15°

with pre-cutter

D mm	NL mm	GL mm	Alpha °	s mm					
14,3	13,5	46	15	8	490990	1	45,60	1	506001

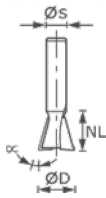

Dovetail cutters

HW S8 D13,8/13,5/15°

for semi-covered dovetail joints SZ 14

D mm	NL mm	GL mm	Alpha °	s mm					
13,8	13,5	46	15	8	490992	1	39,10	1	506001
16	13,5	46	15	8	490993	1	47,10	1	506001
20	17	49	15	8	490996	1	44,30	1	506001
14,3	16	50	10	8	491164	1	40,80	1	506001
20	26	58	10	8	491165	1	47,40	1	506001
13,8	13,5	46	15	8	490991	1	22,40	1	506001
20	17	49	15	8	490995	1	33,50	1	506001

HW S8 D16/13,5/15°

HW S8 D20/17/15°

for semi-covered dovetail joints SZ 20

HW S8 D14,3/16/10°

for open dovetail joints SZO 14

HW S8 D20/26/10°

for open dovetail joint slots, SZO 20

HS S8 D13,8/13,5/15°

for semi-covered dovetail joints SZ 14

HS S8 D20/17/15°

for semi-covered dovetail joints SZ 20

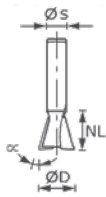

Hand rail cutter HW

HW S8 D22/16/R2,5+6

D mm	NL mm	GL mm	s mm	R1 mm					
22	16	59	8	2,5	491140	1	78,10	1	506001

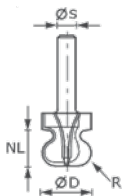

Routing

Denomination and application

Order no. PU Trade price
€ excl. VAT SU DG
per PU ¹⁾

Recessed grip cutter HW with ball bearing guide

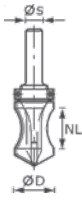

	D mm	NL mm	GL mm	R mm	s mm					
HW S8 R16/NL32	19	19	68	16	8	491033	1	83,00	1	506001

Accessories for hand hole cutter HW

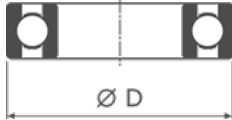

Ball bearing guide, D19 (2x)
diameter 19 mm

						491396	2	21,70	1	506004
--	--	--	--	--	--	--------	---	-------	---	--------

Tongue and groove cutter HW

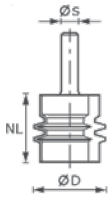

	D mm	NL mm	GL mm	s mm						
HW S8 D34/NL32	34	32	62	8	491034	1	88,30	1	506001	

Mitre tongue and groove cutter

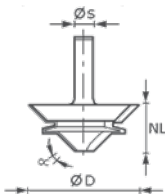

	D mm	NL mm	GL mm	Alpha °	s mm					
HW D 64/27 S12	64	27	67	45	12	492709	1	154,90	1	506001

Script cutter

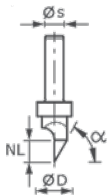

	D mm	NL mm	GL mm	Alpha °	s mm					
HW S8 D11/60°	11	9,5	55	60	8	491003	1	47,10	1	506001
HS S8 D11/60°	11	9,5	55	60	8	491002	1	37,80	1	506001

V-groove cutter

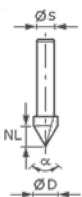

	D mm	NL mm	GL mm	Alpha °	s mm					
HW S8 D14/7/90°	14	7	50	90	8	490999	1	35,20	1	506001
HS S8 D11/9,5/60°	11	9,5	50	60	8	490997	1	15,20	1	506001
HS S8 D14/7/90°	14	7	50	90	8	490998	1	16,40	1	506001

* Attention: Festool products with Bluetooth® technology are not available in all countries.
For more information, please contact the official local Festool import partner.
You can find the overview regarding our products and our partners worldwide on our website www.festool.com

PU = Packaging Units
SU = Shipping Units

¹⁾ Manufacturer's recommended retail price.
Dealer prices may vary.

Denomination and application

Order no. PU Trade price
€ excl. VAT SU DG
per PU ¹⁾

Cutter V groove HW

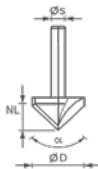
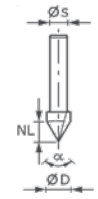

	D mm	NL mm	GL mm	Alpha °	s mm					
HW S8 D12,5/45°	12,5	14	55	45	8	491000	1	47,10	1	506001
HW S8 D32/90°	32	16	49	90	8	491001	1	61,70	1	506001

Cutter spindle for groove cutting disc HW

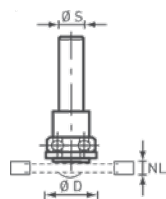
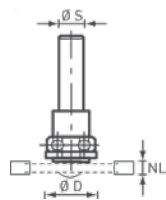
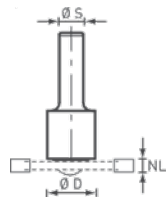

	D mm	Dia. mm	GL mm	BB mm						
S8 1,5-5 D14 for OF 1010, OFK 700, MFK 700; optimised disk cutter mount and minimum distance of 2 mm to the workpiece enable machining of parquet and laminate flooring	14	6	49	-	499805	1	20,10	1	506001	
S8 1,5-5 KL16 for OF 1010, OFK 700, MFK 700; optimised disk cutter mount and minimum distance of 2 mm to the workpiece enable machining of parquet and laminate flooring	16	6	43	16	499803	1	26,10	1	506001	
S8 1,5-5 KL28 for OF 1010, OFK 700, MFK 700; optimised disk cutter mount and minimum distance of 2 mm to the workpiece enable machining of parquet and laminate flooring	28	6	45	28	499804	1	41,40	1	506001	

Groove cutting disc HW

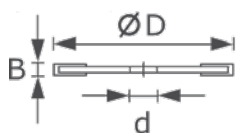

	D mm	Dia. mm	NL mm						
HW D40x1,5	40	6	1,5	491038	1	20,40	1	506001	
HW D40x2	40	6	2	491040	1	21,60	1	506001	
HW D40x2,5	40	6	2,5	491056	1	22,00	1	506001	
HW D40x3	40	6	3	491057	1	22,90	1	506001	
HW D40x3,5	40	6	3,5	491058	1	23,20	1	506001	
HW D40x4	40	6	4	491059	1	23,70	1	506001	
HW D40x5	40	6	5	491060	1	24,40	1	506001	

* Attention: Festool products with Bluetooth® technology are not available in all countries.
For more information, please contact the official local Festool import partner.
You can find the overview regarding our products and our partners worldwide on our website www.festool.com

PU = Packaging Units
SU = Shipping Units

¹⁾ Manufacturer's recommended retail price.
Dealer prices may vary.

Routing

Denomination and application	Order no.	PU	Trade price		
			€ excl. VAT	SU	DG

Accessories for cutter spindle



Ball bearing guide, D16 (2x) hexagon socket screw diameter 16 mm	491384	2	24,30	1	506004
Ball bearing guide, D28 (2x) oval head screw diameter 28 mm	491397	2	26,50	1	506004

Hinge location cutter HW

with HW chip breaker

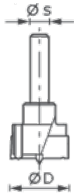

	D mm	GL mm	s mm				
HW S8 D15	15	54,5	8	491070	1	47,10	1 506001
HW S8 D20	20	54,5	8	491072	1	55,10	1 506001
HW S8 D25	25	54,5	8	491073	1	62,70	1 506001
HW S8 D30	30	54,5	8	491075	1	68,30	1 506001
HW S8 D34	34	54,5	8	491076	1	69,40	1 506001
HW S8 D35	35	54,5	8	491077	1	70,30	1 506001

Dowel drill HW

with centring point (excluding 491065)

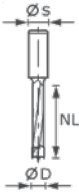

	D mm	NL mm	GL mm	s mm			
HW D3/16	3	16	55	8	491065	1	37,20 1 506001
HW S8 D5/30 Z	5	30	53,5	8	491066	1	25,20 1 506001
HW S8 D6/30 Z	6	30	53,5	8	491067	1	25,90 1 506001
HW S8 D8/30 Z	8	30	53,5	8	491068	1	27,10 1 506001
HW S8 D10/30 Z	10	30	53,5	8	491069	1	29,90 1 506001

Drill HW

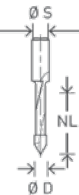

	D mm	NL mm	GL mm	s mm			
HW S8 D5/30	5	30	53,5	8	491064	1	30,40 1 506001

Roman ogee cutter HW with ball bearing guide

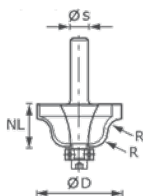

	D mm	NL mm	GL mm	R1 mm	R2 mm			
HW S8 D31,7/R4/R4	31,7	13	53	4	4	491029	1	62,10 1 506001
HW S8 D38,1/R6,35/R6,35	38,1	19	59	6,35	6,35	491030	1	70,80 1 506001

* Attention: Festool products with Bluetooth® technology are not available in all countries.
For more information, please contact the official local Festool import partner.
You can find the overview regarding our products and our partners worldwide on our website www.festool.com

PU = Packaging Units
SU = Shipping Units

¹⁾ Manufacturer's recommended retail price.
Dealer prices may vary.

Routing

Denomination and application	Order no.	PU	Trade price		
			€ excl. VAT	SU	DG

Accessories for double radius cutter

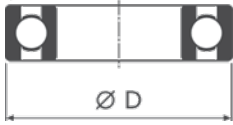

Ball bearing guide, D12,7 (2x)

hexagon socket screw
diameter 12,7 mm

491383 2 14,20 1 506004

Multi-profile cutter HW with ball bearing guide

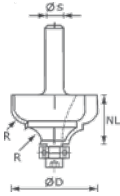

Multi-profile cutter, HW S8 D36,7/R6/R6

with ball bearing guide
D 36,7 mm; NL 21 mm; GL 61 mm; r 6 mm; s 8 mm

491031 1 76,30 1 506001

Accessories for multi-profile cutter



Ball bearing guide, D12,7 (2x)

hexagon socket screw
diameter 12,7 mm

491383 2 14,20 1 506004

Key-hole cutter HW

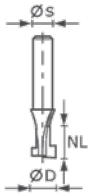

HW S8 D10,5/NL13

	D1	D2	NL1 mm	NL2 mm	GL mm					
	10,5	6	8	5	50	491035	1	35,20	1	506001

Profile/spring cutter HW with ball bearing guide

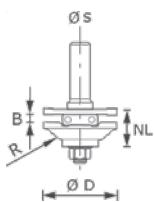

HW S8 D46 x D12-FD

for routing counterprofiles for
cassette frames

	D mm	NL mm	B mm	R mm	s mm					
	46	20	4	22	8	490643	1	192,30	1	506001

Profile/groove cutter HW with ball bearing guide

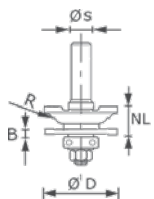

HW S8 D46 x D12-NT

for profiling cassette frames with
grooves for cassette fillings

	D mm	NL mm	B mm	R mm	s mm					
	46	20	4	22	8	490645	1	192,30	1	506001

Routing

Denomination and application

Order no. PU Trade price
€ excl. VAT SU DG
per PU ¹⁾

Counterprofile cutter groove HW with ball bearing guide

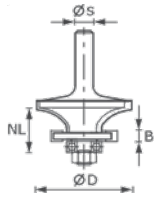

	D mm	NL mm	B mm	R mm	s mm					
HW S8 D43/21 A/KL	43	21	5	16	8	491129	1	113,60	1	506001

Accessories for counterprofile cutter groove HW

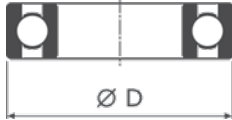

Ball bearing guide, D16 (2x)
hexagon socket screw
diameter 16 mm

491384	2	24,30	1	506004
--------	---	-------	---	--------

Counterprofile cutter spring HW with ball bearing guide

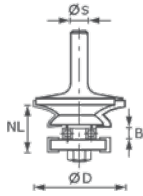

	D mm	NL mm	B mm	R mm	s mm					
HW S8 D43/21 A/KL for profiling cassette frames with grooves for cassette fillings; only in combination with router 491129	43	21	5	16	8	491130	1	113,60	1	506001

Accessories for counterprofile cutter, tongue

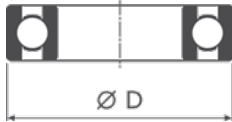

Ball bearing guide, D16 (2x)
hexagon socket screw
diameter 16 mm

491384	2	24,30	1	506004
--------	---	-------	---	--------

Plane cutter HW with ball bearing guide

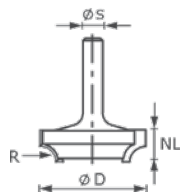

	D mm	NL mm	GL mm	R mm	s mm					
HW D42,7/13/R6 without ball bearing guide	42,7	13	50	6	8	491138	1	74,90	1	506001

Facing cutter HW

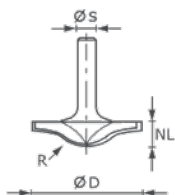

	D mm	NL mm	GL mm	R mm	s mm					
HW D68/14/R35 S12	68	14	58	35	12	492712	1	148,40	1	506001

* Attention: Festool products with Bluetooth® technology are not available in all countries.
For more information, please contact the official local Festool import partner.
You can find the overview regarding our products and our partners worldwide on our website www.festool.com

PU = Packaging Units
SU = Shipping Units

¹⁾ Manufacturer's recommended retail price.
Dealer prices may vary.

Routing

Denomination and application

Order no. PU Trade price
€ excl. VAT SU DG
per PU ¹⁾

Profile cutter radius HW with ball bearing guide

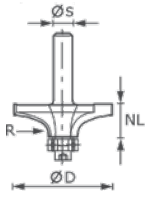

Profile cutter, HW S8 D42/R6

D 42 mm; NL 14 mm; GL 54 mm; r 6 mm; s 8 mm

491131 1 79,20 1 506001

Accessories for profile cutters, radius

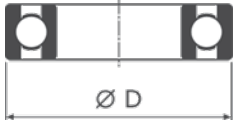

Ball bearing guide, D12,7 (2x)

hexagon socket screw
diameter 12,7 mm

491383 2 14,20 1 506004

Profile cutter HW

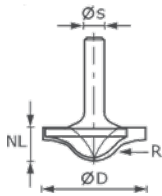

HW S8 D42/13/R6+12

	D mm	NL mm	GL mm	R1 mm	R2 mm					
HW S8 D42/13/R6+12	42	13	50	6	12	491137	1	77,70	1	506001

Aluminium cutter HS

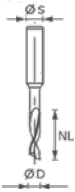

HS S8 D5/NL23

	D mm	NL mm	GL mm	s mm						
HS S8 D5/NL23	5	23	65	8	491036	1	16,40	1	506001	

Shank cutter for processing mineral materials/solid surface materials

Reversible blade groove cutter HW

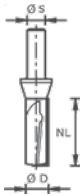

HW S12 D14/45 WM for OF 1400, OF 2200

	D mm	NL mm	GL mm	s mm						
HW S12 D14/45 WM for OF 1400, OF 2200	14	45	105	12	491110	1	203,00	1	506002	

Accessories for turning plate groove cutter





Reversible blade, HM-WP 50x5,5x1,1 (4x)

3 x sink screw, T8 TX spanner, 4 x reversible blade

491389 1 92,20 1 506003

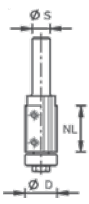
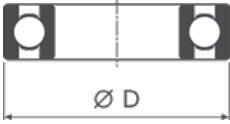
Routing

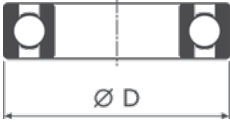
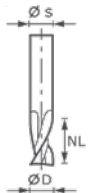
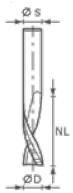
Denomination and application		Order no.	PU	Trade price € excl. VAT per PU ¹⁾	SU	DG				
Turning plate edge trimming cutter HW with ball bearing guide										
	Edge-trimming cutter with reversible blades, HW S12 D21/30WM D 21 mm; NL 30 mm; GL 89 mm; s 12 mm	491120	1	140,70	1	506002				
	Accessories for turning plate edge trimming cutter									
 	Ball bearing guide, D21-15,88 (2x) nut M 6 diameter 21 mm	491408	2	50,00	1	506004				
	Reversible blade, HW-WP 30x12x1,5 (4x) for 492716, 492717, 491120 cutters; main plate; 4 x oval head screw, T15 TX spanner, 4 x reversible blade	491393	1	65,70	1	506003				
Accessories for splash-wall cutter										
	Ball bearing guide, D21-15,88 (2x) nut M 6 diameter 21 mm	491408	2	50,00	1	506004				
	Spiral groove cutter									
	HW D12/25 ss S12 solid TC spiral groove cutter; with right-hand twist; shank 12 mm	12	25	70	12	492654	1	98,40	1	506002
	HW Spi D12/42 RD ss S12 solid TC spiral groove cutter; with right-hand twist; shank 12 mm	12	42	87	12	492655	1	125,80	1	506002
Spiral groove cutter with roughing and finishing, TC										
	HW Spi D12/42 LD ss S12 solid TC roughing and finishing router bit; with left-hand twist	12	42	87	12	492656	1	143,30	1	506002

* Attention: Festool products with Bluetooth® technology are not available in all countries.
 For more information, please contact the official local Festool import partner.
 You can find the overview regarding our products and our partners worldwide on our website www.festool.com

PU = Packaging Units
 SU = Shipping Units

¹⁾ Manufacturer's recommended retail price.
 Dealer prices may vary.

Routing

Denomination and application

Order no. PU Trade price
€ excl. VAT SU DG
per PU ¹⁾

Edge trimming cutter with ball bearing, top

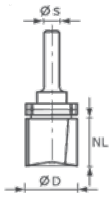

HW D28/25 ss S12
with ball bearing guide

D mm	NL mm	s mm					
28	25	12	492705	1	96,00	1	506002

Accessories for edge trimming cutter with roller bearing at the top



Ball bearing guide, D28
diameter 28 mm

493063	1	31,20	1	506004
--------	---	-------	---	--------

Edge trimming cutter with ball bearing, bottom

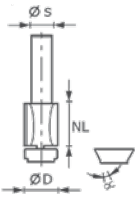

HW D19/25 ss S12
with ball bearing guide; 2nd ball bearing, 11°, for routing
projections

D mm	NL mm	s mm					
19	25	12	492661	1	86,30	1	506002

Accessories for edge trimming cutter with ball bearing, bottom

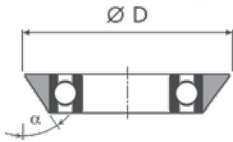

Ball bearing guide, D19
diameter 19 mm

Ball bearing guide, D22/11°
diameter 22 mm

493055	1	23,90	1	506004
493056	1	27,30	1	506004

Accessories for HW chamfer cutter with roller bearing at the top

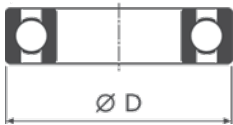

Ball bearing guide, D28
diameter 28 mm

493063	1	31,20	1	506004
--------	---	-------	---	--------

Chamfer cutter HW with ball bearing guide

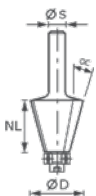

HW D33,54/15° ss S12
with ball bearing guide

D mm	NL mm	Alpha °	s mm					
33,54	25	15	12	492665	1	85,80	1	506002

Routing

Denomination and application						Order no.	PU	Trade price € excl. VAT per PU ¹⁾	SU	DG
Accessories for chamfer cutter with ball bearing guide										
	Ball bearing guide, D18,5/15° diameter 18,5 mm					493057	1	26,40	1	506004
	Accessories for chamfer cutter HW									
	Ball bearing guide, D28 diameter 28 mm					493063	1	31,20	1	506004
	Reservoir cutter HW with ball bearing guide									
	D mm	NL mm	R mm	Alpha °	s mm	492671	1	127,60	1	506002
	HW R6.35/25/6° ss S12 with ball bearing guide									
	D21,1/6° for router 6°					493061	1	26,30	1	506004
	Accessories for reservoir cutter									
	Ball bearing guide, D21,1/6° for router 6° diameter 21,1 mm					493061	1	26,30	1	506004
	Ogee cutter HW with ball bearing guide									
	D mm	NL mm	R mm	s mm	492681	1	75,20	1	506002	
	HW R3/D22 ss S12									

* Attention: Festool products with Bluetooth® technology are not available in all countries.
For more information, please contact the official local Festool import partner.
You can find the overview regarding our products and our partners worldwide on our website www.festool.com

PU = Packaging Units
SU = Shipping Units

¹⁾ Manufacturer's recommended retail price.
Dealer prices may vary.

Routing

Denomination and application	Order no.	PU	Trade price		
			€ excl. VAT	SU	DG

Accessories for HW classic ogee cutter

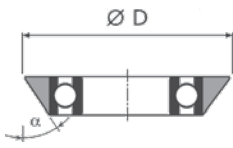

Ball bearing guide, D12,7

fork spanner, A/F 4
diameter 12,7 mm; alpha 6 °

491398 1 18,80 1 506004

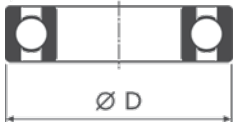

Ball bearing guide, D16

diameter 16 mm

493062 1 23,70 1 506004

Accessories for HW classic ogee cutter, undercut

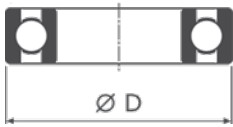

Ball bearing guide, D28

diameter 28 mm

493063 1 31,20 1 506004

Carbide-tipped facing cutter

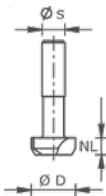

HW D 52/R1ss S12

D mm	NL mm	R mm	s mm	492701	1	96,60	1	506002
52	7,3	1,5	12	492701	1	96,60	1	506002

Cutter tools for machining sandwich material

V-groove cutter

for processing aluminium composite panels

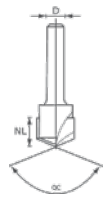

HW S8 D18-135°/Alu

for routers

D mm	NL mm	GL mm	Alpha °	s mm	491443	1	65,70	1	506003
18	3,3	59	135	8	491443	1	65,70	1	506003

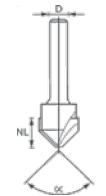

HW S8 D18-90°/Alu

for routers

D mm	NL mm	GL mm	Alpha °	s mm	491444	1	65,70	1	506003
18	8	59	90	8	491444	1	65,70	1	506003

Edge routers

Edge router OFK 500



Edge router, OFK 500 Q-Plus R3

ogee cutter HW R3-OFK (490093), extraction hood, Systainer SYS 2 T-LOC (497564)

574355 1 373,00 1 106002

Edge router, OFK 500 Q-Plus R2

ogee cutter HW R2-OFK (490092), extraction hood, Systainer SYS 2 T-LOC (497564)

574357 1 373,00 1 106002

Edge router, OFK 500 Q-Plus R3

ogee cutter HW R3-OFK (490093), extraction hood, Systainer SYS3 M 187 (204842)

576225 1 375,00 1 106002

Edge router, OFK 500 Q-Plus R2

ogee cutter HW R2-OFK (490092), extraction hood, Systainer SYS3 M 187 (204842)

576227 1 375,00 1 106002

* Attention: Festool products with Bluetooth® technology are not available in all countries.

For more information, please contact the official local Festool import partner. You can find the overview regarding our products and our partners worldwide on our website www.festool.com

PU = Packaging Units
SU = Shipping Units

¹⁾ Manufacturer's recommended retail price. Dealer prices may vary.

Routing

Denomination and application		Order no.	PU	Trade price € excl. VAT per PU ¹⁾	SU	DG
Edge router OFK 700						
	Edge router, OFK 700 EQ-Plus Ø 8 mm clamping collet (488755), extraction hood, edge trimming cutter D 19 x 16 (491666), open ended spanner, WAF 19, Systainer SYS3 M 187 (204842)	576232	1	626,00	1	106002
	Module edge router MFK 700					
 	Module edge router, MFK 700 EQ/B-Plus with ball bearing brake and chip deflector; Ø 8 mm clamping collet (488755), open ended spanner, WAF 19, Systainer SYS3 M 187 (204842)	576241	1	408,00	1	106002
	Module edge router, MFK 700 EQ-Plus Ø 8 mm clamping collet (488755), parallel side fence with fine adjustment and extraction hood (495182), extraction hood, open ended spanner, WAF 19, Systainer SYS3 M 237 (204843)	576240	1	481,00	1	106002
	Module edge router, MFK 700 EQ-Set Ø 8 mm clamping collet (488755), parallel side fence with fine adjustment and extraction hood (495182), 1.5° router table (495165), extraction hood, open ended spanner, WAF 19, Systainer SYS3 M 237 (204843)	576236	1	607,00	1	106002
Accessories for edge routers						
Accessories for OFK 700/MFK 700 slot cutter						
	Router table, FT 0° for MFK/OFK 700; for routing accurate angles	491427	1	107,80	1	206010
	Accessories for module edge router					
Accessories for module edge router MFK 700						
 	Router table, FT-MFK 700 1,5° Set for MFK/OFK 700; tarnishing pad, extraction hood	495165	1	150,70	1	206010
	Parallel side fence, SA-MFK 700 for MFK 700; with fine adjuster; extraction hood, 2 x Guide rods	495182	1	69,70	1	206007

* Attention: Festool products with Bluetooth® technology are not available in all countries.
For more information, please contact the official local Festool import partner.
You can find the overview regarding our products and our partners worldwide on our website www.festool.com

PU = Packaging Units
SU = Shipping Units

¹⁾ Manufacturer's recommended retail price.
Dealer prices may vary.

Routing

Denomination and application

Order no. PU Trade price
€ excl. VAT SU DG
per PU ¹⁾

Cutters for edge router OFK 500 (special shank)

Roundover cutter
without ball bearing guide; without bearing ball

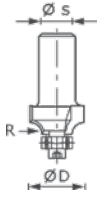

	D mm	R mm					
HW R2-OFK 500	27	2	490092	1	62,90	1	406001
HW R3-OFK 500	27	3	490093	1	62,90	1	406001
HW R4-OFK 500	27	4	490094	1	68,20	1	406001
HW R5-OFK 500	27	5	490095	1	73,60	1	406001
HW R6-OFK 500	27	6	490096	1	73,60	1	406001

Chamfer cutter
without ball bearing guide; without bearing ball

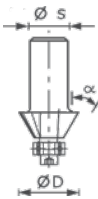

	D mm	Alpha °					
HW 60°-OFK 500	27	60	491533	1	56,30	1	406001
HW 45°-OFK 500	27	45	490090	1	56,30	1	406001
HW 30°-OFK 500	27	30	490091	1	56,30	1	406001

Edge trimming cutter

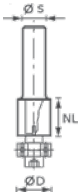

	D mm	NL mm	s mm				
HW/KLS D22/8-OFK for OFK 500; with ball bearing guide	22	8	8	490565	1	70,40	406001
HW D22/8-OFK for OFK 500; without bearing ball	22	8	8	490085	1	56,30	406001

Accessories for cutters OFK 500



Ball bearing guide, KLS-D 15,8-OFK for cutter 490090, 490091, 490092, 490093, 490094, 490095, 490096, 491533; with clamping screw	490249	1	19,80	1	406001
Ball bearing guide, KLS-D22-OFK for cutter 490085; with clamping screw	490250	1	22,40	1	406001

Cutters for edge router OFK/MFK 700

Edge trimming cutter HW

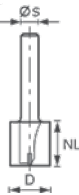

	D mm	NL mm	GL mm	s mm			
HW D 19/16 S8 OFK 700 for OF 1010, OFK 700, MFK 700	19	16	46	8	491666	1	43,90

Routing

Denomination and application

Order no. PU Trade price
€ excl. VAT SU DG
per PU ¹⁾

Turning plate edge trimming cutter HW

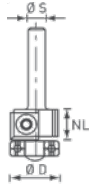

	D mm	NL mm	GL mm	Alpha °	s mm					
S8 HW D19 12x12 KL OFK for OF 1010, OFK 700, MFK 700; optimised bearing mount suitable for 19 mm ball bearing guide or no ball bearing guide; 12 x 12 mm reversible blade can be used 4 times	19	12	52	0	8	499806	1	117,10	1	506001

Accessories for turning plate edge trimming cutter



Ball bearing guide, D19 (2x) nut M 6 diameter 19 mm	491385	2	20,20	1	506004
--	--------	---	-------	---	--------



Reversible blade, HW-WP 12x12x1,5 (4x) 2 x oval head screw, T15 TX spanner, 4 x reversible blade	491391	1	40,20	1	506003
--	--------	---	-------	---	--------

Chamfer cutter HW

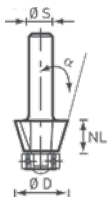

	D mm	NL mm	GL mm	Alpha °	s mm					
S8 HW 15° D18-KL OFK for OF 1010, OFK 700, MFK 700; optimised bearing mount suitable for 12.7 mm ball bearing guide or no ball bearing guide	18	11	50	15	8	499801	1	52,30	1	506001
S8 HW 30° D25-KL OFK for OF 1010, OFK 700, MFK 700; optimised bearing mount suitable for 12.7 mm ball bearing guide or no ball bearing guide	25	11	50	30	8	499800	1	53,20	1	506001
S8 HW 45° D26-KL OFK for OF 1010, OFK 700, MFK 700; optimised bearing mount suitable for 12.7 mm ball bearing guide or no ball bearing guide	26	7	48	45	8	499799	1	56,40	1	506001

Accessories for chamfer cutter HW



Ball bearing guide, D12,7 (2x) hexagon socket screw diameter 12,7 mm	491383	2	14,20	1	506004
---	--------	---	-------	---	--------

Turning plate chamfer cutter HW

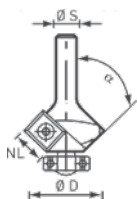

	D mm	NL mm	GL mm	Alpha °	s mm					
S8 HW 45° D27 12x12 KL for OF 1010, OFK 700, MFK 700; optimised bearing mount suitable for 12.7 mm ball bearing guide or no ball bearing guide; 12 x 12 mm reversible blade can be used 4 times	27	8	55	45	8	499807	1	117,10	1	506001

* Attention: Festool products with Bluetooth® technology are not available in all countries.
For more information, please contact the official local Festool import partner.
You can find the overview regarding our products and our partners worldwide on our website www.festool.com

PU = Packaging Units
SU = Shipping Units

¹⁾ Manufacturer's recommended retail price.
Dealer prices may vary.

Accessories for turning plate chamfer cutter HW



D12,7 (2x)
hexagon socket screw

Diameter mm	Order no.	PU	Trade price € excl. VAT per PU ¹⁾	SU	DG
12,7	491383	2	14,20	1	506004



HW-WP 12x12x1,5 (4x)
2 x oval head screw, T15 TX spanner, 4 x reversible blade

Classic ogee cutter HW

shank 8 mm

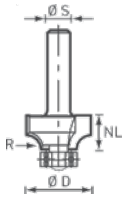

	D mm	NL mm	GL mm	R mm	s mm	Order no.	PU	Trade price € excl. VAT per PU ¹⁾	SU	DG
S8 HW R2 D20-KL OFK for OF 1010, OFK 700, MFK 700; optimised bearing mount suitable for 12.7 mm ball bearing guide or no ball bearing guide	20	2,2	47	2	8	499798	1	60,10	1	506001
S8 HW R3 D22-KL OFK for OF 1010, OFK 700, MFK 700; optimised bearing mount suitable for 12.7 mm ball bearing guide or no ball bearing guide	22	3,2	48	3	8	499797	1	61,20	1	506001

Accessories for HW classic ogee cutter

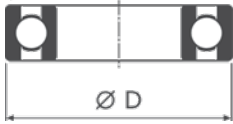

Ball bearing guide, D12,7 (2x)
hexagon socket screw
diameter 12,7 mm

491383	2	14,20	1	506004
--------	---	-------	---	--------

Reversible-blade classic ogee cutter

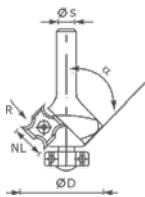

	D mm	NL mm	GL mm	R mm	s mm	Order no.	PU	Trade price € excl. VAT per PU ¹⁾	SU	DG
S8 HW R1 D28 KL12,7 MFK for mod. edge router MFK 700 EQ/B-Plus; reversible blades can be used 4 times	28	3	55	1	8	499811	1	130,50	1	506001
S8 HW R1,5 D28 KL12,7 MFK for mod. edge router MFK 700 EQ/B-Plus; reversible blades can be used 4 times	28	3	55	1,5	8	499810	1	130,50	1	506001
S8 HW R2 D28 KL12,7 MFK for mod. edge router MFK 700 EQ/B-Plus; reversible blades can be used 4 times	28	3	55	2	8	499809	1	130,50	1	506001
S8 HW R3 D28 KL12,7 MFK for mod. edge router MFK 700 EQ/B-Plus; reversible blades can be used 4 times	28	3	55	3	8	499808	1	130,50	1	506001

Routing

Denomination and application

Order no. PU Trade price
€ excl. VAT SU DG
per PU ¹⁾

Accessories for classic ogee cutter HW with reversible blades



	R mm	Ball bearing mm	Diameter mm					
HW-WP R1 D28 KL12,7 OFK for Wepla roundover cutters 499811; reversible blades can be used 4 times	1	12,7	28	500372	1	75,60	1	506001
HW-WP R1,5 D28 KL12,7 OFK for Wepla roundover cutters 499810; reversible blades can be used 4 times	1,5	12,7	28	500371	1	75,60	1	506001
HW-WP R2 D28 KL12,7 OFK for Wepla roundover cutters 499809; reversible blades can be used 4 times	2	12,7	28	500370	1	75,60	1	506001
HW-WP R3 D28 KL12,7 OFK for Wepla roundover cutters 499808; reversible blades can be used 4 times	3	12,7	28	500369	1	75,60	1	506001

Carbide-tipped facing cutter

for mod. edge router MFK 700 EQ/B-Plus

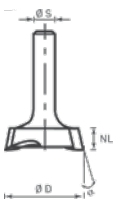

	D mm	NL mm	GL mm	Alpha °	s mm					
S8 HW MFK	28	7	40	15	8	500368	1	88,10	1	506001

Other cutters

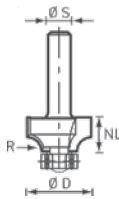

Roundover cutter, S8 HW R2 D20-KL OFK for OF 1010, OFK 700, MFK 700; optimised bearing mount suitable for 12.7 mm ball bearing guide or no ball bearing guide D 20 mm; NL 2,2 mm; GL 47 mm; r 2 mm; s 8 mm	499798	1	60,10	1	506001
--	--------	---	-------	---	--------

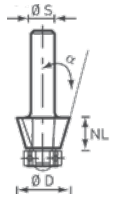

Chamfer cutter, S8 HW 45° D26-KL OFK for OF 1010, OFK 700, MFK 700; optimised bearing mount suitable for 12.7 mm ball bearing guide or no ball bearing guide D 26 mm; NL 7 mm; GL 48 mm; alpha 45 °; s 8 mm	499799	1	56,40	1	506001
---	--------	---	-------	---	--------

Aluminium composite milling machines



Aluminium composite milling machine PF 1200

Aluminium composite milling machine, PF 1200 E-Plus Alucobond V-grooving bit (491470), A4 feeler roller (491539), setting gauge for guide rails, without guide rails, screwdriver, WAF 3, SYS 4 TL Systainer (497566)	574321	1	2.091,00	1	106003
--	--------	---	----------	---	--------

Aluminium composite milling machine, PF 1200 E-Plus Dibond V-grooving bit (491470), D3 feeler roller (491543), setting gauge for guide rails, without guide rails, screwdriver, WAF 3, SYS 4 TL Systainer (497566)	574322	1	2.091,00	1	106003
---	--------	---	----------	---	--------

Accessories for aluminium composite milling machine

Accessories for aluminium composite milling machine PF 1200 E



Follower roll, A3 for aluminium composite milling machine for A3 aluminium composite panels disc size 3 mm	491538	1	38,00	1	206009
Follower roll, A4 for aluminium composite milling machine for A4 aluminium composite panels disc size 4 mm	491539	1	38,00	1	206009
Follower roll, A6 for aluminium composite milling machine for A6 aluminium composite panels disc size 6 mm	491540	1	38,00	1	206009

* Attention: Festool products with Bluetooth® technology are not available in all countries.
For more information, please contact the official local Festool import partner.
You can find the overview regarding our products and our partners worldwide on our website www.festool.com



PU = Packaging Units
SU = Shipping Units

¹⁾ Manufacturer's recommended retail price.
Dealer prices may vary.

Routing

Denomination and application	Order no.	PU	Trade price			DG
			€ excl. VAT	SU	per PU ¹⁾	
 Follower roll, D2 for aluminium composite milling machine for D2 aluminium composite panels disc size 2 mm	491542	1	38,00	1	206009	
Follower roll, D3 for aluminium composite milling machine for D3 aluminium composite panels disc size 3 mm	491543	1	38,00	1	206009	
Follower roll, D4 for aluminium composite milling machine for D4 aluminium composite panels disc size 4 mm	491544	1	38,00	1	206009	
Follower roll, D6 for aluminium composite milling machine for D6 aluminium composite panels disc size 6 mm	491545	1	38,00	1	206009	

Cutting tools for aluminium composite milling machine

Cutting tools for aluminium composite milling machine						
	D mm	Alpha °				
 HW 118x14-90°/Alu	118	90	491470	1	386,70	406002
 HW 118x18-135°/Alu	118	135	491471	1	437,10	406002

* Attention: Festool products with Bluetooth® technology are not available in all countries.
 For more information, please contact the official local Festool import partner.
 You can find the overview regarding our products and our partners worldwide on our website www.festool.com



PU = Packaging Units
 SU = Shipping Units

¹⁾ Manufacturer's recommended retail price.
 Dealer prices may vary.



Joining – DOMINO joining system

Denomination and application	Order no.	PU	Trade price		
			€ excl. VAT	SU	DG

Joining machine

Joining machine DOMINO DF 500						
	Joining machine DOMINO, DF 500 Q-Plus DOMINO cutter D5 (493490), Additional stop (495666), open ended spanner, WAF 8, Systainer SYS3 M 187 (204842)	576413	1	874,00	1	124001
	Joining machine DOMINO, DF 500 Q-Set DOMINO cutter D5 (493490), Additional stop (495666), trim stop (493487), cross stop (498590), open ended spanner, WAF 8, Systainer SYS3 M 187 (204842)	576420	1	960,00	1	124001
Joining machine DOMINO XL DF 700						
	Joining machine DOMINO XL, DF 700 EQ-Plus DOMINO cutter D 12 (497870), Additional stop (495666), empty dowel box, open ended spanner, WAF 12, Systainer SYS3 M 437 (204845)	576426	1	1.209,00	1	124001

Accessories for joining machine DF 500

Connector for DOMINO DF 500 joining machine for DF 500						
	Corner connection, KV D8/50 for DF 500; for 50 corner joints with the DF 500; the DOMINO/DOMINO KV D8/50 connector is positioned both in the cupboard panel and the base of the structure with the DOMINO joiner DF 500; 50 x Split anchor, 50 x Bolt with M4 thread, 50 x Plastic trays, 50 x Cross anchor with threaded pin, without cover caps joint fixture (8 mm DOMINO dowel cross-cuts) D8; dino routing depth for side part 15 mm; DOMINO routing depth for base part 28 mm; drilling diameter in base part 15 mm; panel thickness 18 – 28 mm	203166	50	106,90	1	424003
	Corner connection, KV-LR32 D8/50 for DF 500; for 50 corner joints with the DF 500 and drilling series of holes; the DOMINO/LR 32 KV-LR 32 D8/50 connector is positioned both in the cupboard panel in a 5 mm hole in the series of holes and the base of the structure with the DOMINO joiner DF 500; Split anchor, 50 x Bolt with Euro thread for drilling series of holes, 50 x Plastic trays, 50 x Cross anchor with threaded pin, without cover caps joint fixture (8 mm DOMINO dowel cross-cuts) D8; drilling diameter for Euro bolt 5 mm; DOMINO routing depth for base part 28 mm; drilling diameter in base part 15 mm; panel thickness 18 – 28 mm	203168	50	85,10	1	424003
	Centre panel connector, MSV D8/25 for DF 500; for 25 centre panel joints with the DF 500; drill template is required for drilling holes in the surface of the DOMINO D 8 mm joint fixture; the DOMINO/DOMINO MSV D8/25 connector is positioned both in the cupboard panel and the base of the structure with the DOMINO joiner DF 500; 25 x bolt with external thread for DOMINO centre panel connector, 25 x bolt with internal thread for DOMINO centre panel connector, 50 x Plastic trays, 50 x Cross anchor with threaded pin, without cover caps joint fixture (8 mm DOMINO dowel cross-cuts) D8; dino routing depth for side part 15 mm; DOMINO routing depth for base part 28 mm; drilling diameter in base part 15 mm; panel thickness 18 – 28 mm	203167	25	75,50	1	424003
	Centre panel connector, MSV-LR32 D8/25 for DF 500; for 25 centre panel joints with the DF 500 and drilling series of holes; drill template is required for drilling holes in the surface of the DOMINO D 8 mm joint fixture; the DOMINO/LR 32 MSV-LR 32 D8/25 connector is positioned both in the cupboard panel in a 5 mm hole in the series of holes and the base of the structure with the DOMINO joiner DF 500; 25 x Bolt with external thread for centre panel connector, 25 x Bolt with internal thread for centre panel connector, 50 x Plastic trays, 50 x Cross anchor with threaded pin, without cover caps joint fixture (8 mm DOMINO dowel cross-cuts) D8; drilling diameter for Euro bolt 5 mm; DOMINO routing depth for base part 28 mm; drilling diameter in base part 15 mm; panel thickness 18 – 28 mm	203169	25	68,00	1	424003
	Cover cap, KV-AK D15 brn/50 for DF 500; for covering the DOMINO D 8 mm joint fixture; colour: Light brown	203171	50	6,70	1	424003
	Cover cap, KV-AK D15 str/50 for DF 500; for covering the DOMINO D 8 mm joint fixture; colour: Lacquered silver	203172	50	12,40	1	424003



* Attention: Festool products with Bluetooth® technology are not available in all countries.
For more information, please contact the official local Festool import partner.
You can find the overview regarding our products and our partners worldwide on our website www.festool.com

PU = Packaging Units
SU = Shipping Units

¹⁾ Manufacturer's recommended retail price.
Dealer prices may vary.

Joining – DOMINO joining system

Denomination and application	Order no.	PU	Trade price			DG
			€ excl. VAT	SU	per PU ¹⁾	
 <p>Cover cap, KV-AK D15 wht/50 for DF 500; for covering the DOMINO D 8 mm joint fixture; white</p>	203173	50	6,70	1	424003	
 <p>Cover cap, KV-AK D15 gr/50 for DF 500; for covering the DOMINO D 8 mm joint fixture; Colour: grey</p>	203174	50	6,70	1	424003	
 <p>Drilling template, BS-KV D15 for DF 500; drill template is required for drilling holes in the surface of the DOMINO D 8 mm joint fixture; adapted to Festool D15 hinge location cutter (203165) drill guide dia. 15 mm; panel thickness 18 – 28 mm</p>	203164	1	73,50	1	224001	
 <p>Hinge location cutter, KVB-HW D15 CE 15 mm hinge location cutter is required for drilling holes in the surface of the DOMINO D 8 mm joint fixture; Shaft mount: CENTROTEC; the drill bit is adapted to the Festool drill template (203164); depth stop drill bit dia. 15 mm</p>	203165	1	53,70	1	224001	
 <p>Systainer T-LOC, SORT-SYS1TL DOMINO Empty Systainer SYS 1 T-LOC, contains 3 boxes with flexible compartment division for individual filling of DOMINOs or other accessories or tools; Long plastic containers, Systainer SYS 1 T-LOC (497563)</p>	203176	1	74,00	1	424002	
 <p>DOMINO, beech, D 8x36/130 BU for DF 500; material: Beech; FSC™-certified dimensions 8 x 36 mm</p>	203175	130	16,00	1	424002	
 <p>DOMINO connector range, KV-SYS D8 for DF 500; 70 x DOMINO/DOMINO KV D8 basic structure connector, 20 x DOMINO/LR32 KV-LR32 D8 basic structure connector, 10 x DOMINO/DOMINO MSV D8 centre panel connector, 10 x DOMINO/LR32 MSV-LR32 D8 centre panel connector, 50 light brown cover caps, KV-AK D15 brn (203171), 50 silver cover caps, KV-AK D15 slr (203172), 50 white cover caps, KV-AK D15 wht (203173), 50 grey cover caps, KV-AK D15 gr (203174), 20 x DOMINO D 8 x 36 mm, BS-KV D15 drill template (203164), KVB-HW D15 CE hinge location cutter (203165), Screwdriver, Systainer SYS 1 T-LOC (497563)</p>	203170	1	402,90	1	424003	



Router tool for joining machine DOMINO for DF 500						
	D mm	NL mm				
 <p>D 4-NL 11 HW-DF 500</p>	4	11	495663	1	40,50	424001
 <p>D 5-NL 20 HW-DF 500</p>	5	20	493490	1	34,50	424001

* Attention: Festool products with Bluetooth® technology are not available in all countries.
For more information, please contact the official local Festool import partner.
You can find the overview regarding our products and our partners worldwide on our website www.festool.com

PU = Packaging Units
SU = Shipping Units

¹⁾ Manufacturer's recommended retail price.
Dealer prices may vary.

Joining – DOMINO joining system

Denomination and application	D mm	NL mm	Order no.	PU	Trade price			DG
					€ excl. VAT	SU	per PU ¹⁾	
 D 6-NL 28 HW-DF 500	6	28	493491	1	35,30	1	424001	
 D 8-NL 28 HW-DF 500	8	28	493492	1	36,70	1	424001	
 D 10-NL 28 HW-DF 500	10	28	493493	1	41,20	1	424001	

DOMINO beech material: Beech; for DF 500



	Dimensions mm					
D 4x20/450 BU	4 x 20	495661	450	16,00	1	424002
D 5x30/300 BU	5 x 30	494938	300	16,00	1	424002
D 5x30/1800 BU	5 x 30	493296	1800	85,90	1	424002
D 6x40/190 BU	6 x 40	494939	190	16,00	1	424002
D 6x40/1140 BU	6 x 40	493297	1140	85,90	1	424002
D 8x40/130 BU	8 x 40	494940	130	16,00	1	424002
D 8x40/780 BU	8 x 40	493298	780	85,90	1	424002
D 8x50/100 BU	8 x 50	494941	100	16,00	1	424002
D 8x50/600 BU	8 x 50	493299	600	85,90	1	424002
D 10x50/85 BU	10 x 50	494942	85	16,00	1	424002
D 10x50/510 BU	10 x 50	493300	510	85,90	1	424002

DOMINO, beech range



	Dimensions mm					
DS 4/5/6/8/10 1060x BU for DF 500; DOMINO dowel range 4 x 20, 5 x 30, 6 x 40, 8 x 40, 8 x 50, 10 x 50 mm, DOMINO router for sizes 4, 5, 6, 8 and 10, Systainer SYS 2 T-LOC (497564)	396 x 296 x 157,5	498899	1060	241,30	1	424002

* Attention: Festool products with Bluetooth® technology are not available in all countries.
For more information, please contact the official local Festool import partner.
You can find the overview regarding our products and our partners worldwide on our website www.festool.com

PU = Packaging Units
SU = Shipping Units

¹⁾ Manufacturer's recommended retail price.
Dealer prices may vary.





Joining – DOMINO joining system

Denomination and application	Order no.	PU	Trade price			DG		
			€ excl. VAT	SU	per PU ¹⁾			
DOMINO sipo								
material: Sipo; mahogany dowels; weatherproof; for DF 500								
			Dimensions					
			mm					
	D 5x30/300 MAU		5 x 30	494869	300	31,60	1	424002
	D 5x30/900 MAU		5 x 30	494859	900	85,90	1	424002
	D 6x40/190 MAU		6 x 40	494870	190	31,60	1	424002
	D 6x40/570 MAU		6 x 40	494860	570	85,90	1	424002
	D 8x40/130 MAU		8 x 40	494871	130	31,60	1	424002
	D 8x40/390 MAU		8 x 40	494861	390	85,90	1	424002
	D 8x50/100 MAU		8 x 50	494872	100	31,60	1	424002
	D 8x50/300 MAU		8 x 50	494862	300	85,90	1	424002
	D 10x50/85 MAU		10 x 50	494873	85	31,60	1	424002
	D 10x50/255 MAU		10 x 50	494863	255	85,90	1	424002

Accessories for joining machine DOMINO XL DF 700



Connector for DOMINO XL DF 700 joining machine						
for DF 700						
	Split anchor, SV-SA D14/32					
	for DF 700; for processing using the DOMINO XL DF 700 joining machine; corner connectors for frame and rack joints at material thicknesses of 30 mm or higher; in conjunction with SV-AB D14 anchor bolts and SV-QA D14 cross anchors for creating detachable corner connections	201349	32	33,90	1	424003
	Anchor bolt, SV-AB D14/32					
	for DF 700; for processing using the DOMINO XL DF 700 joining machine; corner connectors for frame and rack joints at material thicknesses of 30 mm or higher; in conjunction with SV-SA D14 split anchors and SV-QA D14 cross anchors for creating corner connections; 64 x dowel half-shells	201350	32	48,00	1	424003
	Cross anchor, SV-QA D14/32					
	for DF 700; for processing using the DOMINO XL DF 700 joining machine; at a material thickness of 30 mm or higher; acts as a counter bearing and tightening element for anchor bolts or double-headed bolts; with soft or porous material such as chipboard, the use of the cross anchor expander SV-V D14 is recommended (for material thickness 35 mm and greater – stops the cross anchor being pulled into the material); in conjunction with SV-SA D14 split anchors and SV-AB D14 anchor bolts for creating corner connections; in conjunction with SV-DB D14 double-headed bolts for creating flat connections; 32 x set screws	201351	32	33,90	1	424003
	Double-headed bolt, SV-DB D14/16					
	for DF 700; for processing using the DOMINO XL DF 700 joining machine; in conjunction with 2x SV-QA D14 cross anchors (and optional SV-V D14 widening clips for soft materials) for creating flat connections in furniture manufacturing; 64 x dowel half-shells	201352	16	36,30	1	424003
	Cover cap, SV-AK D14 str/32					
	for DF 700; for processing using the DOMINO XL DF 700 joining machine; plastic cover caps for closing D14 dowel cross-cuts; colour: Lacquered silver	201354	32	10,50	1	424003
	Cover cap, SV-AK D14 brn1/32					
	for DF 700; for processing using the DOMINO XL DF 700 joining machine; plastic cover caps for closing D14 dowel cross-cuts; colour: Dark brown	201355	32	6,60	1	424003

Joining – DOMINO joining system

Denomination and application		Order no.	PU	Trade price € excl. VAT per PU ¹⁾	SU	DG
	Cover cap, SV-AK D14 brn2/32 for DF 700; for processing using the DOMINO XL DF 700 joining machine; plastic cover caps for closing D14 dowel cross-cuts; colour: Light brown	201356	32	6,60	1	424003
	Extension table, SV-V D14/32 for SV-QA D14 cross anchors; for processing cross anchors for improved pressure distribution for applications in porous or soft materials such as kitchen worktops; prevents the cross anchor being drawn into the material; 64 half-shells for widening 32 cross anchors	201498	32	14,30	1	424003
	DOMINO connector range, SV-SYS D14 for DF 700; for processing using the DOMINO XL DF 700 joining machine; includes corner connectors and flat connectors incl. cover caps and DOMINO wooden dowels; required accessories: DOMINO cutter D 14 (497871); WAF 4 pin wrench for tightening the set screws; 32 anchor bolts, SV-AB D14 (201350), 16 double-headed bolts, SV-DB D14 (201352), 32 split anchors, SV-SA D14 (201349), 32 x DOMINO birch D 14 x 75, 2 x 32 cross anchors, SV-QA D14 (201351), SW 4 pin key, SV-V D14 widener for 32 cross anchors (201498), 32 cover caps, silver, SV-AK D14 slr (201354), 32 cover caps, dark brown, SV-AK D14 brn1 (201355), 32 cover caps, light brown, SV-AK D14 brn2 (201356), Systainer SYS 2 T-LOC (497564)	201353	1	260,60	1	424003
	Connector set, EV/32-Set for DF 700; corner connectors for frame and rack joints at material thicknesses of 30 mm or higher; complete set consisting of anchor bolts, split anchors and cross anchors for 32 corner connectors; 32 anchor bolts, SV-AB D14 (201350), 32 cross anchors, SV-QA D14 (201351), 32 split anchors, SV-SA D14 (201349)	203420	32	118,30	1	424003
	Connector set, FV/16-Set for DF 700; surface connectors, complete set for 16 surface connections consisting of double-headed bolts, cross anchors and wideners; 16 double-headed bolts, SV-DB D14 (201352), 32 cross anchors, SV-QA D14 (201351), SV-V D14 widener for 32 cross anchors (201498)	203421	16	86,20	1	424003

Router tool for joining machine DOMINO

routing tools with threaded supports for the DOMINO joining machine XL DF 700; for DF 700

	D mm	NL mm						
	D 8-NL 50 HW-DF 700	8	50	497868	1	50,00	1	424001
	D 10-NL 70 HW-DF 700	10	70	497869	1	53,30	1	424001

* Attention: Festool products with Bluetooth® technology are not available in all countries.
For more information, please contact the official local Festool import partner.
You can find the overview regarding our products and our partners worldwide on our website www.festool.com

PU = Packaging Units
SU = Shipping Units

¹⁾ Manufacturer's recommended retail price.
Dealer prices may vary.

Joining – DOMINO joining system

Denomination and application

Order no. PU Trade price
€ excl. VAT SU DG
per PU ¹⁾



	D mm	NL mm					
D 12-NL 70 HW-DF 70	12	70	497870	1	55,60	1	424001
D 14-NL 70 HW-DF 70	14	70	497871	1	59,60	1	424001

DOMINO beech

material: Beech; for DF 700







	Dimensions mm					
D 8x80/190 BU	8 x 80	498212	190	44,80	1	424002
D 8x100/150 BU	8 x 100	498213	150	44,80	1	424002
D 10x80/150 BU	10 x 80	498214	150	44,80	1	424002
D 10x100/120 BU	10 x 100	498215	120	44,80	1	424002
D 12x100/100 BU	12 x 100	498216	100	44,80	1	424002
D 12x140/90 BU	12 x 140	498217	90	44,80	1	424002
D 14x75/104 BU	14 x 75	201499	104	43,60	1	424002
D 14x100/80 BU	14 x 100	498218	80	44,80	1	424002
D 14x140/70 BU	14 x 140	498219	70	44,80	1	424002

* Attention: Festool products with Bluetooth® technology are not available in all countries.
For more information, please contact the official local Festool import partner.
You can find the overview regarding our products and our partners worldwide on our website www.festool.com

PU = Packaging Units
SU = Shipping Units

¹⁾ Manufacturer's recommended retail price.
Dealer prices may vary.

Joining – DOMINO joining system

Denomination and application		Order no.	PU	Trade price € excl. VAT per PU ¹⁾	SU	DG	
DOMINO, beech range							
	DS/XL D8/D10 306x BU for DF 700; DOMINO XL beechwood dowel range; DOMINO 8 x 50, 8 x 80, 8 x 100, 10 x 50, 10 x 80, 10 x 100 mm and DOMINO XL cutter for sizes 8 and 10; Systainer SYS 2 T-LOC (497564)	498204	306	215,80	1	424002	
	DS/XL D12/D14 128x BU for DF 700; DOMINO XL beechwood dowel range; DOMINO 12 x 100, 12 x 140, 14 x 100, 14 x 140 mm and DOMINO XL cutter for sizes 12 and 14; Systainer SYS 2 T-LOC (497564)	498205	128	186,30	1	424002	
	DS/XL D8/D10 306x BU for DF 700; DOMINO XL beechwood dowel range; DOMINO 8 x 50, 8 x 80, 8 x 100, 10 x 50, 10 x 80, 10 x 100 mm and DOMINO XL cutter for sizes 8 and 10; Systainer SYS 2 T-LOC (497564)	498204	306	215,80	1	424002	
	DS/XL D12/D14 128x BU for DF 700; DOMINO XL beechwood dowel range; DOMINO 12 x 100, 12 x 140, 14 x 100, 14 x 140 mm and DOMINO XL cutter for sizes 12 and 14; Systainer SYS 2 T-LOC (497564)	498205	128	186,30	1	424002	
Beechwood DOMINOs material: Beech; for DF 700							
		Dimensions mm					
	D 8x750/36 BU	8 x 750	498686	36	64,70	1	424002
	D 10x750/28 BU	10 x 750	498687	28	62,90	1	424002
	D 12x750/22 BU	12 x 750	498688	22	59,10	1	424002
	D 14x750/18 BU	14 x 750	498689	18	59,10	1	424002
Sipo DOMINOs weatherproof; mahogany dowels; for DF 700							
		Dimensions mm					
	D 8x750/36 MAU	8 x 750	498690	36	125,30	1	424002
	D 10x750/28 MAU	10 x 750	498691	28	121,50	1	424002
	D 12x750/22 MAU	12 x 750	498692	22	117,70	1	424002
	D 14x750/18 MAU	14 x 750	498693	18	117,70	1	424002

* Attention: Festool products with Bluetooth® technology are not available in all countries.
For more information, please contact the official local Festool import partner.
You can find the overview regarding our products and our partners worldwide on our website www.festool.com





PU = Packaging Units
SU = Shipping Units



¹⁾ Manufacturer's recommended retail price.
Dealer prices may vary.

Joining – DOMINO joining system

Denomination and application	Order no.	PU	Trade price		
			€ excl. VAT	SU	DG

Accessories for joining machines DOMINO DF 500 and DOMINO XL DF 700







Accessories for joining machines DOMINO for DF 500 and DF 700					
	Trim stop, LA-DF 500/700 for DF 500 and DF 700; for strip material with widths between 22 and 70 mm	493487	1	52,40	224001
	Cross stop, QA-DF 500/700 for DF 500 and DF 700; for repeat hole spacing between 100 and 205 mm; items included: A left and right cross stop; for precise positioning of milling grooves 100-205 mm away from edges	498590	1	55,60	224001
	Handrail fence, RA DF 500/700 for DF 500 and DF 700; for precise routing of round poles Ø 35 - 60 mm	494847	1	43,90	224001
	Additional stop, ZA-DF 500/700 for DF 500 and DF 700; support widener and side stop; for reducing the dowel centre from 37 mm to 20 mm; for secure positioning of the router	495666	1	26,10	224001

DOMINO beech for DF 500 and DF 700					
	SORT-SYS 2 TL DOMINO empty Systainer SYS 2 T-LOC, contains 3 boxes with flexible compartment division for individual filling of DOMINOs;	498889	1	83,60	424002
	SORT-SYS 2 TL DOMINO empty Systainer SYS 2 T-LOC, contains 3 boxes with flexible compartment division for individual filling of DOMINOs;	498889	1	83,60	424002

* Attention: Festool products with Bluetooth® technology are not available in all countries.
For more information, please contact the official local Festool import partner.
You can find the overview regarding our products and our partners worldwide on our website www.festool.com

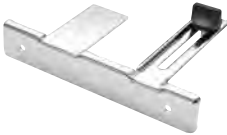
PU = Packaging Units
SU = Shipping Units

¹⁾ Manufacturer's recommended retail price.
Dealer prices may vary.

Denomination and application		Order no.	PU	Trade price € excl. VAT per PU ¹⁾	SU	DG
Planer						
EHL 65 EQ one-handed planer						
	One handed planer, EHL 65 EQ-Plus parallel side fence (488544), hex key, WAF 2, Systainer SYS 2 T-LOC (497564)	576601	1	329,00	1	107001
Planer HL 850						
	Planer, HL 850 EB-Plus Planing head HK 82 SD (484520), parallel side fence (484513), rebate depth stop (484512), extraction adapter (484507), hex key, WAF 5, SYS 3 TL Systainer (497565)	576607	1	598,00	1	107001
Accessories for planers						
Accessories for bench unit						
	Angle stop, WA-HL for HL 850 EB/SE-HL; can also be used as stop for bench unit SE-HL; for planing at angles of 0-45° stop area (length x height) 350 x 70 mm	485018	1	94,00	1	207001
Accessories						
	Parallel side fence, PA-EHL for EHL 65; for side guidance, adjustable between 0 mm and 65 mm	488544	1	16,70	1	207001
	Parallel side fence, PA-HL for HL 850; for side guidance, adjustable between 0 mm and 82 mm	484513	1	21,50	1	207001
	Rebate depth stop, FA-EHL for EHL 65; for rebate depths of 0-23 mm	488543	1	12,90	1	207001
	Rebate depth stop, FA-HL for HL 850; for rebate depths of 0-30 mm	484512	1	11,50	1	207001
	Chip collection bag, SB-EHL for EHL 65; collects the chips produced if a dust extraction system cannot be used	488566	1	41,30	1	207001
	Chip collection bag, SB-HL for HL 850; collects the chips produced if a dust extraction system cannot be used; note: Without suction adapter	484509	1	62,60	1	207001
	Extraction adapter, AD-HL for HL 850; for chip collection bag and suction hose with bushing suction hose diameter 36 mm	484507	1	16,70	1	207001

* Attention: Festool products with Bluetooth® technology are not available in all countries.
For more information, please contact the official local Festool import partner.
You can find the overview regarding our products and our partners worldwide on our website www.festool.com

PU = Packaging Units
SU = Shipping Units

¹⁾ Manufacturer's recommended retail price.
Dealer prices may vary.

Planing

Denomination and application	Order no.	PU	Trade price € excl. VAT per PU ¹⁾	SU	DG
------------------------------	-----------	----	--	----	----

Planer heads and blades

Planer heads



Planer head, HK 82 SD

for HL 850; standard design; with HW carbide-tipped spiral blade HW 82 SD

484520 1 149,50 1 207002



Planer head, HK 82 RF

for HL 850; rustic design, fine; with spiral blade HS 82 RF; includes depth limiter

484521 1 174,40 1 207002



Planer head, HK 82 RG

for HL 850; rustic design, coarse; with HS spiral blade HS 82 RG; includes depth limiter

484522 1 174,40 1 207002



Planer head, HK 82 RW

for HL 850; rustic design, undulating; with HS spiral blade HS 82 RW; includes depth limiter

485331 1 174,40 1 207002

Spiral blade



Spiral blade, HW 82 SD

for planer head HK 82 SD; HW standard planer blades with 82 mm width

484515 1 28,90 1 407001



Spiral blade, HS 82 RF

for planer head HK 82 RF; HSS rustic design, fine

484518 1 35,00 1 407001



Spiral blade, HS 82 RG

for planer head HK 82 RG; HSS rustic design, coarse

484519 1 35,00 1 407001



Spiral blade, HS 82 RW

for planer head HK 82 RW; HSS rustic design, undulating

485332 1 35,00 1 407001



Spiral blade, HW 65

for EHL 65; HW standard planer blades with 65 mm width



488503 1 18,00 1 407001

* Attention: Festool products with Bluetooth® technology are not available in all countries.
For more information, please contact the official local Festool import partner.
You can find the overview regarding our products and our partners worldwide on our website www.festool.com

PU = Packaging Units
SU = Shipping Units

¹⁾ Manufacturer's recommended retail price.
Dealer prices may vary.

Surface preparation



Denomination and application		Order no.	PU	Trade price € excl. VAT per PU ¹⁾	SU	DG
Long-reach sander						
PLANEX easy LHS-E 225 long-reach sander						
	Long-reach sander PLANEX, LHS-E 225 EQ StickFix sanding pad dia. 215 mm (extra soft) (202546), hook-and-loop fastener KV-215 (pack of 5) (205294), LHS-E 225-BAG carrying bag (202477)	571934	1	816,00	1	108011
PLANEX easy LHS-E 225/CT 36 Set long-reach sander						
	Long-reach sander PLANEX, LHS-E 225/CTL36-Set in the LHS-E 225-BAG carrying bag; approval for dust class L; StickFix sanding pad dia. 215 mm (extra soft) (202546), LHS-E 225-BAG carrying bag (202477), hook-and-loop fastener KV-215 (pack of 5) (205294), CTL 36 E AC-LHS mobile dust extractor (574960)	575447	1	1.697,00	1	108011
	Long-reach sander PLANEX, LHS-E 225/CTM 36-Set in the LHS-E 225-BAG carrying bag; approved for dust class M; StickFix sanding pad dia. 215 mm (extra soft) (202546), LHS-E 225-BAG carrying bag (202477), hook-and-loop fastener KV-215 (pack of 5) (205294), CTM 36 E AC-LHS mobile dust extractor (574984)	575455	1	1.889,00	1	108011
Long-reach sander PLANEX LHS 225						
	Long-reach sander PLANEX, LHS 2 225 EQ-Plus eccentric sanding motion for scratch-free surface quality; VL-LHS 2 225 guide extension (205416), SC-LHS 2 225 hose clip (205417), hook-and-loop fastener KV-215 (pack of 5) (205294), Granat P180 pack of five (205667), plug it-power cable (4 m) (203914), sanding pad dia. 220 mm incl. interface pad (205415), Systainer SYS3 XXL 337 (204851)	575989	1	1.248,00	1	108011
Accessories for long-reach sander						
Accessories for the PLANEX easy LHS-E 225 and PLANEX LHS 2 225 long-reach sanders						
	Hook-and-loop fastener, KV-215/5 for securing the cable on the suction hose; suitable for suction hoses with a diameter of 27 mm, 32 mm and 36 mm length 215 mm	205294	5	8,30	1	309003
	Carrying harness, TG-LHS 225 for the PLANEX LHS 2 225 EQ(I), PLANEX 225 EQ and PLANEX LHS-E 225 easy long-reach sanders; working aid for sanding ceilings; additional side-mounted hand grip (496916), SYS Maxi (490701)	496911	1	284,10	1	208009
	Auxiliary handle, ZG-LHS 225 for long-reach sander PLANEX LHS 2 225 EQ(I)	496916	1	53,20	1	208009
Accessories for the PLANEX easy LHS-E 225 long-reach sander						
	Brush segment, BS-LHS-E 225 for the PLANEX easy LHS-E 225 EQ long-reach sander; detachable part of the brush strip of the PLANEX easy LHS-E 225 sanding head	203189	1	29,10	1	208009

* Attention: Festool products with Bluetooth® technology are not available in all countries.
For more information, please contact the official local Festool import partner.
You can find the overview regarding our products and our partners worldwide on our website www.festool.com

PU = Packaging Units
SU = Shipping Units

¹⁾ Manufacturer's recommended retail price.
Dealer prices may vary.





Surface preparation

Denomination and application	Order no.	PU	Trade price		
			€ excl. VAT	SU	DG
 <p>Brush strip, BE-LHS-E 225 for the PLANEX easy LHS-E 225 EQ long-reach sander; as a replacement for used brush strip</p>	203190	1	41,90	1	208009
 <p>Bag, LHS-E 225-BAG for the PLANEX easy LHS-E 225 EQ long-reach sander; transport bag with shoulder straps</p>	202477	1	95,70	1	208009

Accessories for the PLANEX LHS 225 EQ and PLANEX LHS 2 225 EQI long-reach sanders

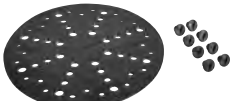
 <p>Brush segment, BS-LHS 225 for long-reach sander PLANEX; not for the PLANEX LHS 2 225 EQ long-reach sander; detachable part of the brush strip of the PLANEX LHS 225 EQ sanding head</p>	495166	1	29,10	1	208009
 <p>Brush strip, BE-LHS 225 for long-reach sander PLANEX; not for the PLANEX LHS 2 225 EQ long-reach sander; as a replacement for used brush strip</p>	495167	1	41,90	1	208009
 <p>Guide extension, VL-LHS 225 for long-reach sander PLANEX; not for the PLANEX LHS 2 225 EQ long-reach sander; quick guide extension of the PLANEX for high ceilings length 500 mm</p>	495169	1	214,00	1	208009
 <p>Sanding pad, ST-STF-D215/8-LHS 225-SW for PLANEX, PLANEX easy long-reach sanders; not for the PLANEX LHS 2 225 EQ long-reach sander; for universal use on plain and arced surfaces; ultra-soft, adaptable sanding pad diameter 215 mm</p>	202546	1	108,10	1	408003
 <p>Sanding pad, ST-STF-D215/8-IP-LHS 225 for long-reach sander PLANEX; not for the PLANEX LHS 2 225 EQ long-reach sander; for all types of applications, particularly suited for curved surfaces; incl. 2 interface pads; not recommended for PLANEX easy LHS-E 225 diameter 215 mm</p>	496106	1	120,70	1	408003
 <p>Interface pad, IP-STF-D215/8/2x for the PLANEX 225 EQ long-reach sander; not suitable for PLANEX LHS 2 225 EQ(I) (from September 2020), not suitable for PLANEX LHS-E 225 EQ; as damping element between sanding disc and sanding pad; for use with sanding pad 496106 height 5 mm; diameter 215 mm</p>	496140	2	32,80	1	408006
 <p>Sanding pad, ST-D220/48-LHS 2 225 for long-reach sander PLANEX LHS 2 225 EQ(I); not suitable for PLANEX LHS 225 EQ (until September 2020), not suitable for PLANEX LHS-E 225 EQ; for creating a perfect and scratch-free surface; the sanding pad may only be used if the IP-STF-D220/48-LHS 2 225 interface pad is fastened; interface pad including eight plastic screws [205418] diameter 220 mm</p>	205415	1	83,10	1	408003



Surface preparation

Denomination and application	Order no.	PU	Trade price € excl. VAT per PU ¹⁾	SU	DG
 <p>Interface pad, IP-STF-D220/48-LHS 2 225 for long-reach sander PLANEX LHS 2 225 EQ(I); not suitable for PLANEX LHS 225 EQ (until September 2020), not suitable for PLANEX LHS-E 225 EQ; must be used in conjunction with the ST-D220/48-LHS 2 225 sanding pad; can be attached to the sanding pad with eight plastic screws supplied; easy to screw in the screws using a second screw or coin (no screwdriver is required); StickFix hook-and-loop surface for securing and quickly changing abrasives; 8 x plastic screw diameter 220 mm</p>	205418	1	20,60	1	408006
 <p>Interface pad, IP-D220-LHS 2 225-SW for long-reach sander PLANEX LHS 2 225 EQ(I); not suitable for PLANEX LHS 225 EQ (until September 2020), not suitable for PLANEX LHS-E 225 EQ; for sanding particularly soft materials diameter 220 mm</p>	577252	1	28,30	1	408006
 <p>Guide extension, VL-LHS 2 225 for long-reach sander PLANEX LHS 2 225 EQ(I); not suitable for PLANEX LHS 225 EQ (until September 2020), not suitable for PLANEX LHS-E 225 EQ; quick extension of the LHS 2 225 long-reach sander by 450 mm; a maximum of two guide extensions can be used at the same time (one is already included in the scope of delivery of the PLANEX LHS 2 225) total length 500 mm; Extension action 450 mm</p>	205416	1	187,10	1	208009
 <p>Hose clip, SC-LHS 2 225 for long-reach sander PLANEX LHS 2 225 EQ(I); for securing the suction hose and cable on either the left hand or right hand T-handle end of the PLANEX LHS 2 225; for a trouble free handle area when sanding ceilings</p>	205417	1	10,40	1	208009

Systainer with inserts for abrasives

 <p>Systainer³, SYS-STF-D225 for long-reach sander PLANEX LHS 2 225 EQ(I); with insert for abrasive, dia. 225 mm number of compartments 5; SYSTAINER size SYS3 M 337 mm; dimensions (L x W x H) 396 x 296 x 337</p>	576786	1	78,20	1	214001
--	--------	---	-------	---	--------

Geared eccentric sanders

 <p>Geared eccentric sander ROTEX RO 90 DX</p> <p>Geared eccentric sander ROTEX, RO 90 DX FEQ-Plus FastFix sanding pad, Ø 90 mm (soft-HT) [496804], StickFix sanding pad V93, Festool PROTECTOR [496801], Systainer SYS3 M 187 [204842]</p>	576259	1	535,00	1	108002
 <p>Geared eccentric sander ROTEX RO 125</p> <p>Geared eccentric sander ROTEX, RO 125 FEQ-Plus FastFix sanding pad Ø 125 mm (soft-HT) [492125], Festool PROTECTOR [493912], Systainer SYS3 M 187 [204842]</p>	576029	1	544,00	1	108002

* Attention: Festool products with Bluetooth® technology are not available in all countries.
For more information, please contact the official local Festool import partner.
You can find the overview regarding our products and our partners worldwide on our website www.festool.com



PU = Packaging Units
SU = Shipping Units

¹⁾ Manufacturer's recommended retail price.
Dealer prices may vary.



Surface preparation

Denomination and application	Order no.	PU	Trade price		
			€ excl. VAT	SU	DG
Geared eccentric sander ROTEX RO 150 MULTI-JETSTREAM 2					
 Geared eccentric sander ROTEX, RO 150 FEQ MULTI-JETSTREAM 2 FastFix sanding pad Ø 150 mm (soft W) [202461], Festool PROTECTOR (493913)	575066	1	596,00	1	108002
Geared eccentric sander ROTEX, RO 150 FEQ-Plus MULTI-JETSTREAM 2 FastFix sanding pad Ø 150 mm (soft W) [202461], Festool PROTECTOR (493913), Systainer SYS3 M 237 [204843]	576017	1	641,00	1	108002

Accessories for geared eccentric sander





Accessories for ROTEX RO 90 FEQ					
 Protector, FESTOOL 90FX for RO 90 DX; for protecting the sanding pad and workpiece with minimal edge distance	496801	1	12,10	1	208001
 Protector set, FP-RO 90 for RO 90 DX; window protectors S, M, L correspond to approx. 4, 8, 12 mm distance from the edge, depending on frame angle	497936	3	34,10	1	208001

Accessories for ROTEX RO 125 FEQ					
 Protector, FESTOOL 125FX for RO 90 DX; for protecting the sanding pad and workpiece with minimal edge distance	493912	1	12,10	1	208001

Accessories for ROTEX RO 150 FEQ					
 Protector, FESTOOL 150FX for RO 150 FEQ; for protecting the sanding pad and workpiece with minimal edge distance	493913	1	15,00	1	208001
 Auxiliary handle, ZG-RAS/RO for RO 150, RAS, WTS 150, RAP 150	487865	1	8,90	1	208010
 Handle, BG-RO 150 for RO 150 FEQ	495188	1	23,30	1	208001



FastFix sanding pad Ø 90 mm					
for RO 90 DX					
 Sanding pad, ST-STF D90/7 FX H-HT for RO 90 DX; hard version; fastener resistant to high temperatures; for plain surfaces and narrow edges connecting thread FastFix	495623	1	35,70	1	408003

Surface preparation

Denomination and application	Order no.	PU	Trade price € excl. VAT per PU ¹⁾	SU	DG
 <p>Sanding pad, ST-STF D90/7 FX W-HT for RO 90 DX; soft version; fastener resistant to high temperatures connecting thread FastFix</p>	496804	1	35,70	1	408003
 <p>Interface pad, IP-STF-D90/6 for RO 90 DX; as damping element between sanding disc and sanding pad; Interface pad D 90 mm height 15 mm; diameter 90 mm</p>	497481	1	9,30	1	408006
 <p>Sanding pad, SSH-GE-STF-R090 DX suitable for abrasive V93; for RO 90 DX; delta sanding pad; plate without interchangeable sanding pad; for attaching StickFix sanding pad, soft and hard connecting thread FastFix</p>	496802	1	29,10	1	408004
 <p>Sanding pad, SSH-STF-V93/6-H/2 for DX 93, RO 90 DX; StickFix adhesive layer for quick change of sanding pad; hard version</p>	488716	2	17,40	1	408004
 <p>Sanding pad, SSH-STF-V93/6-W/2 for DX 93, RO 90 DX; StickFix adhesive layer for quick change of sanding pad; soft version</p>	488715	2	17,40	1	408004
 <p>Sanding pad, LSS-STF-R090 V93/6 suitable for abrasive V93; for RO 90 DX; plate incl. interchangeable sanding pad; slat sanding pad V93; for sanding in tight spaces</p>	496803	1	35,70	1	408004
 <p>Sanding pad, LSS-STF-R090 V93 E replacement backing pad for slat sanding pad</p>	497483	1	27,50	1	408004

MULTI-JETSTREAM 2 FastFix sanding pad Ø 125 mm (hard H/soft W/extra soft SW)

for RO 125 FEQ





 <p>Sanding pad, ST-STF D125/8 FX-H-HT for RO 125 FEQ; hard version; fastener resistant to high temperatures; high edge solidity; for plain surfaces and narrow edges connecting thread FastFix</p>	492127	1	43,90	1	408003
 <p>Sanding pad, ST-STF D125/8 FX-W-HT for RO 125 FEQ; soft version; fastener resistant to high temperatures connecting thread FastFix</p>	492125	1	43,90	1	408003
 <p>Sanding pad, ST-STF D125/8 FX-SW for RO 125 FEQ; ultra-soft version; elastic structure; for heavy roundings and cambers connecting thread FastFix</p>	492126	1	43,90	1	408003

* Attention: Festool products with Bluetooth® technology are not available in all countries.
For more information, please contact the official local Festool import partner.
You can find the overview regarding our products and our partners worldwide on our website www.festool.com



PU = Packaging Units
SU = Shipping Units

¹⁾ Manufacturer's recommended retail price.
Dealer prices may vary.

Surface preparation

Denomination and application		Order no.	PU	Trade price € excl. VAT per PU ¹⁾	SU	DG
	FastFix louver pad, LT-STF D125/RO125 for RO 125 FEQ; FastFix; for sanding louvers diameter 125 mm; connecting thread FastFix	492129	1	45,90	1	408003
	Interface pad, IP-STF-D120/8-J for sanding contoured parts and fine-sanding parts with eccentric sander Ø 125 mm; as damping element between sanding disc and sanding pad; JETSTREAM height 15 mm; diameter 120 mm; hole circle diameter 90 mm	492271	1	11,30	1	408006
MULTI-JETSTREAM 2 FastFix sanding pad Ø 150 mm (hard H/soft W/extra soft SW) for RO 150 FEQ						
	Sanding pad, ST-STF D150/MJ2-FX-H-HT for RO 150 FEQ; hard version; fastener resistant to high temperatures; high edge solidity; for plain surfaces and narrow edges; MULTI-JETSTREAM 2 diameter 150 mm; connecting thread FastFix	202463	1	56,30	1	408003
	Sanding pad, ST-STF D150/MJ2-FX-W-HT for RO 150 FEQ; soft version; fastener resistant to high temperatures; for universal use on plain and arced surfaces; MULTI-JETSTREAM 2 diameter 150 mm; connecting thread FastFix	202461	1	56,30	1	408003
	Sanding pad, ST-STF D150/MJ2-FX-SW for RO 150 FEQ; ultra-soft version; elastic structure; MULTI-JETSTREAM 2; for heavy roundings and cambers diameter 150 mm; connecting thread FastFix	202462	1	56,30	1	408003

Eccentric sanders

Cordless random orbit sander ETSC 125 EC-engine; JETSTREAM; 2 mm eccentric stroke; you can find the compatible batteries and chargers available as accessories under "Battery and charging technology"						
	Cordless eccentric sander, ETSC 125-Basic without battery pack, without charger, StickFix sanding pad Ø 125 mm (soft-HT) (492280), Festool PROTECTOR (201690), long-life chip collection bag (201693), Systainer SYS3 M 187 (204842)	576370	1	305,00	1	108014
ETS EC 125/3 eccentric sander EC-engine; JETSTREAM; 3 mm eccentric stroke						
	Eccentric sander, ETS EC 125/3 EQ-Plus StickFix sanding pad Ø 125 mm (soft-HT) (492286), screwdriver, WAF 5, Systainer SYS3 M 187 (204842)	576341	1	580,00	1	108012

Surface preparation

Denomination and application		Order no.	PU	Trade price € excl. VAT per PU ¹⁾	SU	DG
Eccentric sander ETS 125 JETSTREAM; 2 mm eccentric stroke						
	Eccentric sander, ETS 125 REQ StickFix sanding pad Ø 125 mm (soft-HT) (492280), Festool PROTECTOR (201690), long-life chip collection bag (201693)	201213	1	318,00	1	108010
	Eccentric sander, ETS 125 REQ-Plus StickFix sanding pad Ø 125 mm (soft-HT) (492280), Festool PROTECTOR (201690), long-life chip collection bag (201693), Systainer SYS3 M 187 (204842)	576069	1	353,00	1	108010
Eccentric sander ETS EC 150/3 EC-engine; MULTI-JETSTREAM 2; 3 mm eccentric stroke						
	Eccentric sander, ETS EC 150/3 EQ for fine sanding; MULTI-JETSTREAM 2 M8 sanding pad Ø 150 mm (extra soft SW) (202459), screwdriver, WAF 5	575032	1	544,00	1	108012
	Eccentric sander, ETS EC 150/3 EQ-Plus for fine sanding; MULTI-JETSTREAM 2 M8 sanding pad Ø 150 mm (extra soft SW) (202459), screwdriver, WAF 5, Systainer SYS3 M 187 (204842)	576320	1	580,00	1	108012
Eccentric sander ETS 150/3 MULTI-JETSTREAM 2; 3 mm eccentric stroke						
	Eccentric sander, ETS 150/3 EQ for fine sanding; MULTI-JETSTREAM 2 M8 sanding pad Ø 150 mm (extra soft SW) (202459), filter cartridge, screwdriver, WAF 5	575023	1	371,00	1	108010
	Eccentric sander, ETS 150/3 EQ-Plus for fine sanding; MULTI-JETSTREAM 2 M8 sanding pad Ø 150 mm (extra soft SW) (202459), filter cartridge, screwdriver, WAF 5, Systainer SYS3 M 187 (204842)	576072	1	411,00	1	108010
Eccentric sander ETS EC 150/5 EC-engine; MULTI-JETSTREAM 2; 5 mm eccentric stroke						
	Eccentric sander, ETS EC 150/5 EQ for coarse and intermediate sanding; MULTI-JETSTREAM 2 M8 sanding pad Ø 150 mm (soft W) (202458), screwdriver, WAF 5	575043	1	544,00	1	108012
	Eccentric sander, ETS EC 150/5 EQ-GQ for coarse and intermediate sanding; MULTI-JETSTREAM 2 M8 sanding pad Ø 150 mm (soft W) (202458), screwdriver, WAF 5, suction hose D27/22x3.5 m AS-GQ (200041)	575403	1	696,00	1	108012
	Eccentric sander, ETS EC 150/5 EQ-Plus for coarse and intermediate sanding; MULTI-JETSTREAM 2 M8 sanding pad Ø 150 mm (soft W) (202458), screwdriver, WAF 5, Systainer SYS3 M 187 (204842)	576329	1	580,00	1	108012
Eccentric sander ETS 150/5 MULTI-JETSTREAM 2; 5 mm eccentric stroke						
	Eccentric sander, ETS 150/5 EQ for coarse and intermediate sanding; MULTI-JETSTREAM 2 M8 sanding pad Ø 150 mm (soft W) (202458), filter cartridge, screwdriver, WAF 5	575057	1	371,00	1	108010
	Eccentric sander, ETS 150/5 EQ-Plus for coarse and intermediate sanding; MULTI-JETSTREAM 2 M8 sanding pad Ø 150 mm (soft W) (202458), filter cartridge, screwdriver, WAF 5, Systainer SYS3 M 187 (204842)	576080	1	411,00	1	108010

* Attention: Festool products with Bluetooth® technology are not available in all countries.
For more information, please contact the official local Festool import partner.
You can find the overview regarding our products and our partners worldwide on our website www.festool.com

PU = Packaging Units
SU = Shipping Units

¹⁾ Manufacturer's recommended retail price.
Dealer prices may vary.

Surface preparation

Denomination and application

Order no. PU Trade price
€ excl. VAT SU DG
per PU ¹⁾

Accessories for eccentric sanders

Battery pack and mains adapter



BP 18 Li 3,1 Ergo
for RTSC 400, DTSC 400, ETSC 125 cordless sanders; Lithium-ion (Li-ion) battery pack for the Festool 18 V ETSC 125, RTSC 400 and DTSC 400 cordless sanders; not compatible with all other Festool cordless tools; ergonomic, lightweight design

	Tensioner V	Capacity Ah	Product weight kg	Input voltage V	Rated power W					
	18	3,1	0,4	-	-	202499	1	76,00	1	230002
	18 - 20	-	0,3	220 - 240	150	202501	1	123,10	1	230003



ACA 220-240/18V Ergo
for RTSC 400, DTSC 400, ETSC 125 cordless sanders; not compatible with all other Festool cordless tools; for continuous electrical operation of the RTSC 400, DTSC 400, ETSC 125 cordless sanders; ergonomic, lightweight design; plug it-power cable (4 m) [203914]

Sanding pad Ø 125 mm



Sanding pad, ST-STF 125/8-M8-J H
for ETS EC 125, LEX 125; hard version; fastener resistant to high temperatures; high edge solidity; for plain surfaces and narrow edges; JETSTREAM connecting thread M8

492284	1	54,80	1	408003
492286	1	54,80	1	408003
492288	1	54,80	1	408003
492280	1	53,30	1	408003
492282	1	53,30	1	408003
492271	1	11,30	1	408006



Sanding pad, ST-STF 125/8-M8-J W-HT
for ETS EC 125, LEX 125; soft version; fastener resistant to high temperatures; for universal use on plain and arced surfaces; JETSTREAM connecting thread M8



Sanding pad, ST-STF 125/8-M8-J SW
for ETS EC 125, LEX 125; ultra-soft version; elastic structure; for heavy roundings and cambers; JETSTREAM connecting thread M8



Sanding pad, ST-STF 125/8-M4-J W-HT
for ES 125, ETS 125, ETSC 125; soft version; fastener resistant to high temperatures; for universal use on plain and arced surfaces; JETSTREAM connecting thread M4; hole circle diameter 90 mm



Sanding pad, ST-STF 125/8-M4-J SW
for ES 125, ETS 125, ETSC 125; ultra-soft version; elastic structure; for heavy roundings and cambers; JETSTREAM connecting thread M4; hole circle diameter 90 mm



Interface pad, IP-STF-D120/8-J
for sanding contoured parts and fine-sanding parts with eccentric sander Ø 125 mm; as damping element between sanding disc and sanding pad; JETSTREAM height 15 mm; diameter 120 mm; hole circle diameter 90 mm

* Attention: Festool products with Bluetooth® technology are not available in all countries.
For more information, please contact the official local Festool import partner.
You can find the overview regarding our products and our partners worldwide on our website www.festool.com

PU = Packaging Units
SU = Shipping Units

¹⁾ Manufacturer's recommended retail price.
Dealer prices may vary.

Surface preparation

Denomination and application		Order no.	PU	Trade price € excl. VAT per PU ¹⁾	SU	DG
MULTI-JETSTREAM 2 M8 sanding pad Ø 150 mm (hard H/soft W/extra soft SW)						
	Sanding pad, ST-STF D150/MJ2-M8-H-HT for ETS 150, ETS EC 150, LEX 150 and WTS 150/7; hard version; fastener resistant to high temperatures; high edge solidity; for plain surfaces and narrow edges; MULTI-JETSTREAM 2 diameter 150 mm; connecting thread M8	202460	1	56,30	1	408003
	Sanding pad, ST-STF D150/MJ2-M8-W-HT for ETS 150, ETS EC 150, LEX 150 and WTS 150/7; soft version; fastener resistant to high temperatures; for universal use on plain and arced surfaces; MULTI-JETSTREAM 2 diameter 150 mm; connecting thread M8	202458	1	56,30	1	408003
	Sanding pad, ST-STF D150/MJ2-M8-SW for ETS 150, ETS EC 150, LEX 150 and WTS 150/7; ultra-soft version; elastic structure; for heavy roundings and cambers; MULTI-JETSTREAM 2 diameter 150 mm; connecting thread M8	202459	1	56,30	1	408003
	Sanding pad, ST-STF D150/17 MJ 5/16" for external machines; for Desoutter: Mod.575, Mod.576; for Hamach/Rupes: BR3/E/ST/E ST, TA151ST; for Orka: ROA1 D/E, DAA1 D/E; MULTI-JETSTREAM connecting thread 5/16"	496210	1	59,70	1	408003
	Interface pad, IP-STF D150/MJ2-5/2 for eccentric sander with diameter of 150 mm; as damping element between sanding disc and sanding pad; MULTI-JETSTREAM 2 diameter 145 mm; height 5 mm	203348	2	24,40	1	408006
	Interface pad, IP-STF D150/MJ2-15/1 for eccentric sander with diameter of 150 mm; as damping element between sanding disc and sanding pad; MULTI-JETSTREAM 2 diameter 145 mm; height 15 mm	203351	1	15,60	1	408006
Protector and dust collection bag						
	Protector, PR ETS-R 125 for ETS 125 REQ, ETSC 125; for smooth sanding along window panes, frames and panelling; for protecting the sanding pad and workpiece with minimal edge distance	201690	1	11,60	1	208001
	Long-life chip collection bag, SB-Longlife RTS/DTS/ETS for RTS 400, RTSC 400, DTS 400, DTSC 400, ETS 125, ETSC 125; for holding dust and for dust-free disposal of the extracted product	201693	1	31,80	1	208001

* Attention: Festool products with Bluetooth® technology are not available in all countries.
For more information, please contact the official local Festool import partner.
You can find the overview regarding our products and our partners worldwide on our website www.festool.com

PU = Packaging Units
SU = Shipping Units

¹⁾ Manufacturer's recommended retail price.
Dealer prices may vary.

Surface preparation

Denomination and application	Order no.	PU	Trade price			
			€ excl. VAT	SU	DG	
Guide control black						
	Guide control black powder, HB-Set for visibly checking surfaces to be sanded; hand sanding block, 2 guide control black powder cartridges (each 30 g) (495940)	495939	2	41,60	1	508015
	Refillable cartridge, 2 x 30 g refill for the guide control black powder HB set (2 x 30 g)	495940	2	19,50	1	508015

Turbo filter bag						
	Turbo filter bag, TF-RS 400/5 for RS 400, RTS 400, DS 400, DTS 400, ES 125, ETS 125; for insertion in filter cartridge; paper filter bag for turbo dust extraction	489128	5	10,20	5	208002
	Turbo filter bag, TF-RS 400/25 for RS 400, RTS 400, DS 400, DTS 400, ES 125, ETS 125; for insertion in filter cartridge; paper filter bag for turbo dust extraction	489127	25	41,80	1	208002
	Turbo filter bag, TF II-RS/ES/ET/5 for RS 300, RS 3, RS 200, RS 2, ES 150, ETS 150, ET 2; for insertion in filter cartridge; paper filter bag for turbo dust extraction	487779	5	9,10	5	208002
	Turbo filter bag, TF II-RS/ES/ET/25 for RS 300, RS 3, RS 200, RS 2, ES 150, ETS 150, ET 2; for insertion in filter cartridge; paper filter bag for turbo dust extraction	487871	25	36,90	1	208002

Turbo filter bag set						
	Turbo filter bag set, TFS-RS 400 for RS 400, RTS 400, DS 400, DTS 400, ES 125, ETS 125; not for new generation RTS/DTS 400 REQ and ETS 125 REQ; paper filter bag for turbo dust extraction and one plastic holder; filter cartridge, 5 x turbo filter bag	489129	1	25,70	1	208002
	Turbo filter bag set, TFS-ES 150 for ES 150, ETS 150; for clear view and healthy working environment; not suitable for ETS EC 125/150; paper filter bag for turbo dust extraction and one plastic holder; filter cartridge, turbo filter bag	489631	1	27,90	1	208001
	Turbo filter bag set, TFS II-ET/RS for RS 300, RS 3, RS 200, RS 2, ET2; paper filter bag for turbo dust extraction and one plastic holder; filter cartridge, 5 x turbo filter bag	487780	1	27,90	1	208002





Edge sander

ES-ETS 125 edge sander						
	Edge sander, ES-ETS 125 REQ-Plus for sanding filled, painted and solid wood edges in fixed angular positions without any tipping; AH-ES-ETS/ETSC positioning aid (205316), StickFix sanding pad Ø 125 mm (soft-HT) (492280), long-life chip collection bag (201693), plug it-power cable (4 m) (203914), hex key, WAF 5, Systainer SYS3 M 337 (204844)	576678	1	425,00	1	108015

Surface preparation

Denomination and application	Order no.	PU	Trade price € excl. VAT per PU ¹⁾	SU	DG
------------------------------	-----------	----	--	----	----

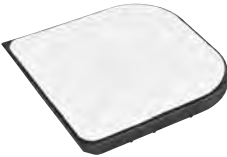

Accessories for cordless edge sanders and edge sanders

Accessories for cordless edge sanders and edge sanders					
	Positioning aid, AH-ES-ETS/ETSC for ETS 125 REQ, ETSC 125, ES-ETS 125 and ES-ETSC 125; not suitable for ETS EC 125 & ETS 125 & ES 125; for sanding filled, painted and solid wood edges in fixed angular positions without any tipping; LAS-H-ES base runner (205491), LAS-W-ES base runner (205492), hex key, WAF 5 Angle adjustment 43 - 92 °; Edge height 5 - 60 mm	205316	1	134,20	1 208011
	Base runner, LAS-H-ES for AH-ES-ETS/ETSC, ES-ETSC and ES-ETS; plastic all-round crossheaded guide for wood or similar materials	205491	1	13,50	1 208011
	Base runner, LAS-W-ES for AH-ES-ETS/ETSC, ES-ETSC and ES-ETS; GB-LAS-STF-ES slideway lining	205492	1	20,70	1 208011
	Slideway lining, GB-LAS-STF-ES/5 for AH-ES-ETS/ETSC, LAS-W-ES, ES-ETSC and ES-ETS; velour slideway lining for quick and simple replacement; use a separate slideway lining for different applications, e.g. oiled and painted surfaces	205493	1	22,90	1 408005

Geared/orbital sanders for rough sanding

Geared orbital sander RUTSCHER RS 100 C					
	Geared orbital sanders RUTSCHER, RS 100 CQ-Plus StickFix sanding pad 115 x 221 mm (488226), Systainer SYS 2 T-LOC (497564)	567699	1	575,00	1 108003

Direct drive orbital sanders for fine sanding

Orbital sander RUTSCHER RS 200					
	Orbital sander RUTSCHER, RS 200 EQ-Plus StickFix sanding pad 115 x 225 mm (483679), filter cartridge, Systainer SYS 2 T-LOC (497564)	567841	1	537,00	1 108003
Orbital sander RUTSCHER RS 300					
	Orbital sander RUTSCHER, RS 300 EQ-Plus StickFix sanding pad 93 x 175 mm (483905), filter cartridge, Systainer SYS 2 T-LOC (497564)	567845	1	433,00	1 108003



* Attention: Festool products with Bluetooth® technology are not available in all countries.
For more information, please contact the official local Festool import partner.
You can find the overview regarding our products and our partners worldwide on our website www.festool.com

PU = Packaging Units
SU = Shipping Units



¹⁾ Manufacturer's recommended retail price.
Dealer prices may vary.

Surface preparation



Denomination and application	Order no.	PU	Trade price		
			€ excl. VAT	SU	DG
Cordless orbital sander RTSC 400 EC-engine; you can find the compatible batteries and chargers available as accessories under "Battery and charging technology"					
	Cordless orbital sander, RTSC 400-Basic without battery pack, without charger, StickFix sanding pad 80 x 130 mm (489252), Festool PROTECTOR (201691), long-life chip collection bag (201693), Systainer SYS3 M 187 (204842)				
	576347	1	305,00	1	108013

RTS 400 Orbital sander					
	Orbital sander RUTSCHER, RTS 400 REQ StickFix sanding pad 80 x 130 mm (489252), Festool PROTECTOR (201691), long-life chip collection bag (201693)				
	201224	1	318,00	1	108003
	Orbital sander RUTSCHER, RTS 400 REQ-Plus StickFix sanding pad 80 x 130 mm (489252), Festool PROTECTOR (201691), long-life chip collection bag (201693), Systainer SYS3 M 187 (204842)				
	576057	1	353,00	1	108003

Cordless delta sander DTSC 400 EC-engine; you can find the compatible batteries and chargers available as accessories under "Battery and charging technology"					
	Cordless delta sander, DTSC 400-Basic without battery pack, without charger, StickFix sanding pad 100 x 150 mm (493723), Festool PROTECTOR (201692), long-life chip collection bag (201693), Systainer SYS3 M 187 (204842)				
	576359	1	305,00	1	108013

Delta sander DTS 400					
	Delta sander, DTS 400 REQ StickFix sanding pad 100 x 150 mm (493723), Festool PROTECTOR (201692), long-life chip collection bag (201693)				
	201231	1	318,00	1	108003
	Delta sander, DTS 400 REQ-Plus StickFix sanding pad 100 x 150 mm (493723), Festool PROTECTOR (201692), long-life chip collection bag (201693), Systainer SYS3 M 187 (204842)				
	576064	1	353,00	1	108003

Accessories for orbital sanders

Battery pack and mains adapter										
	Tensioner V	Capacity Ah	Product weight kg	Input voltage V	Rated power W					
	BP 18 Li 3,1 Ergo for RTSC 400, DTSC 400, ETSC 125 cordless sanders; Lithium-ion (Li-ion) battery pack for the Festool 18 V ETSC 125, RTSC 400 and DTSC 400 cordless sanders; not compatible with all other Festool cordless tools; ergonomic, lightweight design									
	18	3,1	0,4	-	-	202499	1	76,00	1	230002
	ACA 220-240/18V Ergo for RTSC 400, DTSC 400, ETSC 125 cordless sanders; not compatible with all other Festool cordless tools; for continuous electrical operation of the RTSC 400, DTSC 400, ETSC 125 cordless sanders; ergonomic, light-weight design; plug it-power cable (4 m) (203914)									
	18 - 20	-	0,3	220 - 240	150	202501	1	123,10	1	230003

Sanding pads and accessories										
	Sanding pad, SSH-STF-115x225/10 for RS 200, RS 2, RS 100, RS 1; StickFix adhesive layer for quick change of sanding pad dimensions 115 x 225 mm									
	483679	1	38,90	1	408004					

Surface preparation





Denomination and application		Order no.	PU	Trade price € excl. VAT per PU ¹⁾	SU	DG
	Sanding pad, SSH-STF-115x225/10-KS for RS 200, RS 2, RS 100, RS 1; StickFix adhesive layer for quick change of sanding pad; with edge protection dimensions 115 x 225 mm	485648	1	43,70	1	408004
	Sanding pad, SSH-115x225/10 for RS 200, RS 2, RS 100, RS 1; for abrasives for clamping dimensions 115 x 225 mm	489629	1	34,30	1	408004
	Sanding pad, SSH-STF-115x221/10 RS 1 C for RS 100 C, RS 1 C; StickFix adhesive layer for quick change of sanding pad dimensions 115 x 221 mm	488226	1	38,90	1	408004
	Sanding pad, SSH 115x221/10-RS 1 C for RS 100 C, RS 1 C; for abrasives for clamping dimensions 115 x 221 mm	492310	1	32,20	1	408004
	Sanding pad, SSH-STF-93x175/8 for RS 300, RS 3, LRS 93; StickFix adhesive layer for quick change of sanding pad dimensions 93 x 175 mm	483905	1	33,00	1	408004
	Sanding pad, SSH-93x175/8 for RS 300, RS 3, LRS 93; for abrasives for clamping dimensions 93 x 175 mm	489630	1	28,90	1	408004
	Slat sanding pad, SSH-STF-L93x230/0 for RS 300, RS 3, LRS 93; StickFix; lamellar sanding pad version dimensions 93 x 230 mm	486371	1	36,70	1	408004
	Iron sanding pad, SSH-STF-V93x266/14 for RS 300, RS 3, LRS 93; StickFix; pressing iron sanding pad version dimensions 93 x 266 mm	486418	1	47,30	1	408004
	Sanding pad, SSH-STF-80x130/12 for RTS 400, RS 400, RTSC 400; StickFix adhesive layer for quick change of sanding pad; perforated with 12 suction holes dimensions 80 x 130 mm	489252	1	27,80	1	408004
	Sanding pad, SSH-STF-80x130/8 for RS 4; StickFix adhesive layer for quick change of sanding pad; perforated with eight suction holes dimensions 80 x 130 mm	483906	1	28,40	1	408004
	Sanding pad, SSH-STF-Delta100x150/7 for DTS 400, DTSC 400, DS 400; StickFix adhesive layer for quick change of sanding pad; for sanding even in corners dimensions 100 x 150 mm	493723	1	31,60	1	408004



* Attention: Festool products with Bluetooth® technology are not available in all countries.
For more information, please contact the official local Festool import partner.
You can find the overview regarding our products and our partners worldwide on our website www.festool.com





PU = Packaging Units
SU = Shipping Units

¹⁾ Manufacturer's recommended retail price.
Dealer prices may vary.

Surface preparation

Denomination and application	Order no.	PU	Trade price		
			€ excl. VAT	SU	DG
			per PU ¹⁾		
 <p>Sanding pad, SSH-STF-V93/6-H/2 for DX 93, RO 90 DX; StickFix adhesive layer for quick change of sanding pad; hard version</p>	488716	2	17,40	1	408004
 <p>Sanding pad, SSH-STF-V93/6-W/2 for DX 93, RO 90 DX; StickFix adhesive layer for quick change of sanding pad; soft version</p>	488715	2	17,40	1	408004
 <p>Flat sanding pad, SSH-STF-V93L/6 for DX 93; StickFix</p>	488036	1	15,50	1	408004
 <p>Conversion kit, TP-STF-V93-W for DX 93; plate TP-STF-DX93 and sanding pad SSH-STF-V93/6-W, both with snap stud; StickFix</p>	488899	1	19,70	1	408004
 <p>Plate, TP-STF-DX93 for DX 93; component with StickFix coating onto which sanding pad is secured</p>	488717	1	14,10	1	408004

Protector and dust collection bag					
 <p>Protector, PR RTS-R 80x133 for RTS 400 REQ, RTSC 400; for smooth sanding along window panes, frames and panelling; for protecting the sanding pad and workpiece with minimal edge distance</p>	201691	1	11,60	1	208002
 <p>Protector, PR DTS-R 100x150 for DTS 400 REQ, DTSC 400; for smooth sanding along window panes, frames and panelling; for protecting the sanding pad and workpiece with minimal edge distance</p>	201692	1	11,60	1	208002
 <p>Long-life chip collection bag, SB-Longlife RTS/DTS/ETS for RTS 400, RTSC 400, DTS 400, DTSC 400, ETS 125, ETSC 125; for holding dust and for dust-free disposal of the extracted product</p>	201693	1	31,80	1	208001



Turbo filter bag					
 <p>Turbo filter bag, TF-RS 1/5 for RS 100, RS 1; for insertion in filter cartridge; paper filter bag for turbo dust extraction</p>	483674	5	10,60	5	208002
 <p>Turbo filter bag, TF II-RS/ES/ET/5 for RS 300, RS 3, RS 200, RS 2, ES 150, ETS 150, ET 2; for insertion in filter cartridge; paper filter bag for turbo dust extraction</p>	487779	5	9,10	5	208002
 <p>Turbo filter bag, TF II-RS/ES/ET/25 for RS 300, RS 3, RS 200, RS 2, ES 150, ETS 150, ET 2; for insertion in filter cartridge; paper filter bag for turbo dust extraction</p>	487871	25	36,90	1	208002
 <p>Turbo filter bag, TF-RS 400/5 for RS 400, RTS 400, DS 400, DTS 400, ES 125, ETS 125; for insertion in filter cartridge; paper filter bag for turbo dust extraction</p>	489128	5	10,20	5	208002
 <p>Turbo filter bag, TF-RS 400/25 for RS 400, RTS 400, DS 400, DTS 400, ES 125, ETS 125; for insertion in filter cartridge; paper filter bag for turbo dust extraction</p>	489127	25	41,80	1	208002

* Attention: Festool products with Bluetooth® technology are not available in all countries.
For more information, please contact the official local Festool import partner.
You can find the overview regarding our products and our partners worldwide on our website www.festool.com

PU = Packaging Units
SU = Shipping Units

¹⁾ Manufacturer's recommended retail price.
Dealer prices may vary.





Surface preparation

Denomination and application	Order no.	PU	Trade price € excl. VAT per PU ¹⁾	SU	DG
Turbo filter bag set					
 <p>Turbo filter bag set, TFS-RS 400 for RS 400, RTS 400, DS 400, DTS 400, ES 125, ETS 125; not for new generation RTS/ DTS 400 REQ and ETS 125 REQ; paper filter bag for turbo dust extraction and one plastic holder; filter cartridge, 5 x turbo filter bag</p>	489129	1	25,70	1	208002
 <p>Turbo filter bag set, TFS II-ET/RS for RS 300, RS 3, RS 200, RS 2, ET2; paper filter bag for turbo dust extraction and one plastic holder; filter cartridge, 5 x turbo filter bag</p>	487780	1	27,90	1	208002

Linear sander

Linear sander DUPLEX LS 130					
 <p>Linear sander DUPLEX, LS 130 EQ-Plus StickFix profile sanding pad standard (490161), profile sanding pad 90° (490162), Systainer SYS 1 T-LOC (497563)</p>	567850	1	469,00	1	108003

Accessories for linear sander

Profile sanding pads with tool-free FastFix sanding pad change; for LS 130					
 <p>Flat sanding pad, SSH-STF-LS130-F for LS 130; standard design dimensions 80 x 130 mm</p>	490161	1	32,40	1	408004
 <p>Rebate profile sanding pad, SSH-STF-LS130-90 GR for LS 130; 90 degrees dimensions 80 x 130 mm</p>	490162	1	35,20	1	408004
 <p>Radius profile sanding pad, SSH-STF-LS130-R6KV for LS 130; radius R6 concave dimensions 80 x 130 mm</p>	490163	1	35,20	1	408004
 <p>Radius profile sanding pad, SSH-STF-LS130-R10KV for LS 130; radius R10 concave dimensions 80 x 130 mm</p>	491197	1	35,20	1	408004
 <p>Radius profile sanding pad, SSH-STF-LS130-R18KV for LS 130; radius R18, concave dimensions 80 x 130 mm</p>	490164	1	35,20	1	408004

* Attention: Festool products with Bluetooth® technology are not available in all countries.
For more information, please contact the official local Festool import partner.
You can find the overview regarding our products and our partners worldwide on our website www.festool.com

PU = Packaging Units
SU = Shipping Units

¹⁾ Manufacturer's recommended retail price.
Dealer prices may vary.

Surface preparation

Denomination and application		Order no.	PU	Trade price € excl. VAT per PU ¹⁾	SU	DG
	Radius profile sanding pad, SSH-STF-LS130-R25KV for LS 130; radius R25, concave dimensions 80 x 130 mm	490165	1	35,20	1	408004
	V-groove profile sanding pad, SSH-STF-LS130-V10 for LS 130 dimensions 80 x 130 mm; minimum basic dimension of the V-groove 10 mm	490166	1	35,20	1	408004
	Flute profile sanding pad, SSH-STF-LS130-R5KX for LS 130; radius R5 convex dimensions 80 x 130 mm	491198	1	35,20	1	408004
	Flute profile sanding pad, SSH-STF-LS130-R15KX for LS 130; radius R15 convex dimensions 80 x 130 mm	490167	1	35,20	1	408004
	DIY construction kit, SSH-STF-LS130 Kit for LS 130; kit for creating any type of profiling pad	490780	1	50,30	1	408004
	Interface pad, IP-STF-80x133/12-STF LS130/2 for LS 130; damping element between sanding pad and abrasive dimensions 80 x 133 mm; height 5 mm	490160	2	14,30	1	408006
	Flat sanding pad, SSH-STF-LS130-LL195 for LS 130; for relief grinding of facings dimensions 80 x 195 mm	491861	1	20,30	1	408004

Rotary sanders

	Rotary sander RAS 180 Rotary sander, RAS 180 E StickFix sanding pad Ø 180 (485253), extraction hood, StickFix abrasive discs, screwdriver, WAF 4, open ended spanner, WAF 19	570774	1	762,00	1	108005
--	--	--------	---	--------	---	--------

Surface preparation

Denomination and application	Order no.	PU	Trade price		
			€ excl. VAT	SU	DG

Accessories for rotary sander

Accessories for rotary sander



Auxiliary handle, ZG-RAS/RO
for RO 150, RAS, WTS 150, RAP 150

487865 1 8,90 1 208010



Adapter, AD-D10/M14
for Festool stirrers: to mount in a drill chuck; for sanding disc with M14 thread: for mounting in drilling and boring machines; for polishing pad Ø 80: for use in cordless drills
camping flange dia. 10 mm

483944 1 21,10 1 311001

Sanding pad Ø 115 mm



Sanding pad, ST-STF-D115/0-M14 W
for RAS 115; soft version; for universal use on plain and arced surfaces
connecting thread M14

484173 1 25,60 1 408003



Sanding pad, ST-STF-D115/0-M14 H
for RAS 115; hard version; for plain surfaces and narrow edges
connecting thread M14

484172 1 26,30 1 408003



Sanding pad, ST-D115/0-M14/2F
for RAS 115; for fibre discs and Longlife fibre discs Ø 115 mm
connecting thread M14

485298 1 25,50 1 408003

Sanding pad Ø 180 mm



Sanding pad, ST-STF-D180/0-M14 W
for RAS 180; soft version; for universal use on plain and arced surfaces
connecting thread M14

485253 1 51,40 1 408003



Sanding pad, ST-D180/0-M14/2F
for RAS 180; for fibre discs Ø 180 mm
connecting thread M14

485296 1 51,40 1 408003

Belt sanders



Belt sander BS 75

Belt sander, BS 75 E
dust bag (490819), extraction adapter (490818), slip band P100





575770 1 404,00 1 108004

* Attention: Festool products with Bluetooth® technology are not available in all countries.
For more information, please contact the official local Festool import partner.
You can find the overview regarding our products and our partners worldwide on our website www.festool.com



PU = Packaging Units
SU = Shipping Units

¹⁾ Manufacturer's recommended retail price.
Dealer prices may vary.



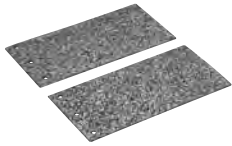
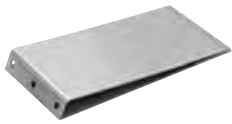

Surface preparation

Denomination and application		Order no.	PU	Trade price € excl. VAT per PU ¹⁾	SU	DG
	Belt sander, BS 75 E-Plus dust bag (490819), extraction adapter (490818), slip band P100, stationary unit (490820), SYS Maxi (490701)	575769	1	478,00	1	108004
	Belt sander, BS 75 E-Set dust bag (490819), extraction adapter (490818), slip band P100, stationary unit (490820), surface sanding frame (490827), SYS Maxi (490701)	575771	1	612,00	1	108004
Belt sander BS 105						
	Belt sander, BS 105 dust bag (490819), extraction adapter (490818), slip band P100	575767	1	586,00	1	108004
	Belt sander, BS 105 E-Plus dust bag (490819), extraction adapter (490818), slip band P100, stationary unit (490820), SYS Maxi (490701)	575766	1	715,00	1	108004
	Belt sander, BS 105 E-Set dust bag (490819), extraction adapter (490818), slip band P100, stationary unit (490820), surface sanding frame (490828), SYS Maxi (490701)	575768	1	878,00	1	108004

Accessories for belt sanders

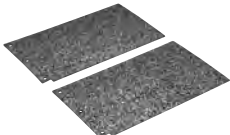
Accessories						
	Extraction adapter, AA-BS 75/105 for BS 75, BS 105; for connecting suction hose to belt sander	490818	1	17,60	1	208003
	Dust bag, AS-BS 75/105 for BS 75, BS 105	490819	1	34,20	1	208003
	Bench unit, SE-BS 75/105 for BS 75, BS 105	490820	2	31,10	1	208003
	Sanding base, SU/GG-BS 75 for BS 75; from fabric/graphite	490823	2	15,60	1	208003
	Sanding base, SU/KM-BS 75 for BS 75; made from cork/metal for coarse sanding work	490824	1	11,00	1	208003



Surface preparation

Denomination and application	Order no.	PU	Trade price		
			€ excl. VAT	SU	DG
			per PU ¹⁾		
 <p>Sanding base, SU/GG-BS 105 for BS 105; from fabric/graphite</p>	490825	2	17,60	1	208003
 <p>Sanding base, SU/KM-BS 105 for BS 105; made from cork/metal for coarse sanding work</p>	490826	1	12,70	1	208003
 <p>Sanding frame, FSR-BS 75 for BS 75; quick installation without a tool</p>	204803	1	181,60	1	208003
 <p>Sanding frame, FSR-BS 105 for BS 105; quick installation without a tool</p>	204802	1	228,40	1	208003

Brush machine

 <p>Brush machine RUSTOFIX BMS 180 Brush machine, BMS 180 E RUSTOFIX; LD 85 brush (411549), KB 85 brush (411969), extraction hood, tool arbour, Clamping flange, screwdriver, WAF 4, open ended spanner, WAF 11, open ended spanner, WAF 14, open ended spanner, WAF 24, case</p>	570775	1	1.104,00	1	108005
---	--------	---	----------	---	--------

Accessories for brush machine

Rustilon brushes					
	Exterior dia. mm	Width mm	Hole dia. mm		
 <p>LD 85 for BMS 180; with standard steel wire, steel core; for texturing</p>	150	85	50	411549	188,40
 <p>KB 85 for BMS 180; plastic bristles with embedded K80 grit, die-cast plastic core; for intermediate sanding</p>	150	85	16 - 30	411969	172,60
 <p>BG 80 for BMS 180; with sisal bristles, steel core; for smoothing</p>	150	80	50	411887	140,20

* Attention: Festool products with Bluetooth® technology are not available in all countries.
For more information, please contact the official local Festool import partner.
You can find the overview regarding our products and our partners worldwide on our website www.festool.com

PU = Packaging Units
SU = Shipping Units

¹⁾ Manufacturer's recommended retail price.
Dealer prices may vary.

Sanding with compressed air

Denomination and application

Order no. PU Trade price
€ excl. VAT SU DG
per PU ¹⁾

Compressed air eccentric sander

Compressed air eccentric sander LEX 3 77/2.5



Compressed air eccentric sander, LEX 3 77/2,5

Note: an IAS 2/IAS 3 connecting system is required for operation; StickFix sanding pad Ø 77 mm W-HT (soft) (498694), bottle of cleaning and lubricating oil LFC 9022 (50 ml) (201077), screwdriver, WAF 4

691131	1	421,00	1	108007
--------	---	--------	---	--------

Compressed air eccentric sander LEX 3 125/3



Compressed air eccentric sander, LEX 3 125/3

Note: an IAS 2/IAS 3 connecting system is required for operation; StickFix sanding pad Ø 125 mm (extra soft) (492288), bottle of cleaning and lubricating oil LFC 9022 (50 ml) (201077), screwdriver, WAF 5

691140	1	608,00	1	108007
--------	---	--------	---	--------

Compressed air eccentric sander LEX 3 125/5



Compressed air eccentric sander, LEX 3 125/5

Note: an IAS 2/IAS 3 connecting system is required for operation; StickFix sanding pad Ø 125 mm (soft-HT) (492286), bottle of cleaning and lubricating oil LFC 9022 (50 ml) (201077), screwdriver, WAF 5

691141	1	608,00	1	108007
--------	---	--------	---	--------

Compressed air eccentric sander LEX 3 150/3



Compressed air eccentric sander, LEX 3 150/3

Note: an IAS 2/IAS 3 connecting system is required for operation; MULTI-JETSTREAM 2 M8 sanding pad Ø 150 mm (extra soft SW) (202459), bottle of cleaning and lubricating oil LFC 9022 (50 ml) (201077), screwdriver, WAF 5

574996	1	608,00	1	108007
--------	---	--------	---	--------

Compressed air eccentric sander LEX 3 150/5



Compressed air eccentric sander, LEX 3 150/5

Note: an IAS 2/IAS 3 connecting system is required for operation; MULTI-JETSTREAM 2 M8 sanding pad Ø 150 mm (soft W) (202458), bottle of cleaning and lubricating oil LFC 9022 (50 ml) (201077), screwdriver, WAF 5

575081	1	608,00	1	108007
--------	---	--------	---	--------

Compressed air eccentric sander LEX 3 150/7



Compressed air eccentric sander, LEX 3 150/7

Note: an IAS 2/IAS 3 connecting system is required for operation; MULTI-JETSTREAM 2 M8 sanding pad Ø 150 mm (soft W) (202458), screwdriver, WAF 5, bottle of cleaning and lubricating oil LFC 9022 (50 ml) (201077)

575077	1	608,00	1	108007
--------	---	--------	---	--------

* Attention: Festool products with Bluetooth® technology are not available in all countries.
For more information, please contact the official local Festool import partner.
You can find the overview regarding our products and our partners worldwide on our website www.festool.com

PU = Packaging Units
SU = Shipping Units

¹⁾ Manufacturer's recommended retail price.
Dealer prices may vary.

Sanding with compressed air

Denomination and application	Order no.	PU	Trade price		
			€ excl. VAT	SU	DG

Accessories for compressed air sander

Sanding pad Ø 77 mm						
	Sanding pad, ST-STF-D77/6-M5 W for LEX 3 77; soft version; for universal use on plain and arced surfaces diameter 77 mm; connecting thread M5	498694	1	33,00	1	408003
	Interface pad, IP-STF-D77/6 for LEX 3 77; as damping element between sanding disc and sanding pad height 10 mm; diameter 77 mm	498818	2	19,80	1	408006

Sanding pad Ø 125 mm						
	Sanding pad, ST-STF 125/8-M8-J H for ETS EC 125, LEX 125; hard version; fastener resistant to high temperatures; high edge solidity; for plain surfaces and narrow edges; JETSTREAM connecting thread M8	492284	1	54,80	1	408003
	Sanding pad, ST-STF 125/8-M8-J W-HT for ETS EC 125, LEX 125; soft version; fastener resistant to high temperatures; for universal use on plain and arced surfaces; JETSTREAM connecting thread M8	492286	1	54,80	1	408003
	Sanding pad, ST-STF 125/8-M8-J SW for ETS EC 125, LEX 125; ultra-soft version; elastic structure; for heavy roundings and cambers; JETSTREAM connecting thread M8	492288	1	54,80	1	408003
	Interface pad, IP-STF-D120/8-J for sanding contoured parts and fine-sanding parts with eccentric sander Ø 125 mm; as damping element between sanding disc and sanding pad; JETSTREAM height 15 mm; diameter 120 mm; hole circle diameter 90 mm	492271	1	11,30	1	408006

Sanding pad Ø 150 mm						
	Sanding pad, ST-STF D150/MJ2-M8-H-HT for ETS 150, ETS EC 150, LEX 150 and WTS 150/7; hard version; fastener resistant to high temperatures; high edge solidity; for plain surfaces and narrow edges; MULTI- JETSTREAM 2 diameter 150 mm; connecting thread M8	202460	1	56,30	1	408003
	Sanding pad, ST-STF D150/MJ2-M8-W-HT for ETS 150, ETS EC 150, LEX 150 and WTS 150/7; soft version; fastener resistant to high temperatures; for universal use on plain and arced surfaces; MULTI- JETSTREAM 2 diameter 150 mm; connecting thread M8	202458	1	56,30	1	408003

* Attention: Festool products with Bluetooth® technology are not available in all countries.
 For more information, please contact the official local Festool import partner.
 You can find the overview regarding our products and our partners worldwide on our website www.festool.com

PU = Packaging Units
 SU = Shipping Units

¹⁾ Manufacturer's recommended retail price.
 Dealer prices may vary.



Sanding with compressed air

Denomination and application		Order no.	PU	Trade price € excl. VAT per PU ¹⁾	SU	DG
	Sanding pad, ST-STF D150/MJ2-M8-SW for ETS 150, ETS EC 150, LEX 150 and WTS 150/7; ultra-soft version; elastic structure; for heavy roundings and cambers; MULTI-JETSTREAM 2 diameter 150 mm; connecting thread M8	202459	1	56,30	1	408003
	Sanding pad, ST-STF D150/17 MJ 5/16" for external machines; for Desoutter: Mod.575, Mod.576; for Hamach/Rupes: BR3/E/ST/E ST, TA151ST; for Orka: ROA1 D/E, DAA1 D/E; MULTI-JETSTREAM connecting thread 5/16"	496210	1	59,70	1	408003
	Interface pad, IP-STF D150/MJ2-5/2 for eccentric sander with diameter of 150 mm; as damping element between sanding disc and sanding pad; MULTI-JETSTREAM 2 diameter 145 mm; height 5 mm	203348	2	24,40	1	408006
	Interface pad, IP-STF D150/MJ2-15/1 for eccentric sander with diameter of 150 mm; as damping element between sanding disc and sanding pad; MULTI-JETSTREAM 2 diameter 145 mm; height 15 mm	203351	1	15,60	1	408006
Sanding pad Ø 185 mm						
	Sanding pad, ST-STF-D185/16-M8 W for LEX 185; soft version; for universal use on plain and arced surfaces connecting thread M8	490514	1	65,30	1	408003
	Sanding pad, ST-STF-D185/16-M8 SW for LEX 185; ultra-soft version; elastic structure; for heavy roundings and cambers connecting thread M8	490526	1	65,30	1	408003
Guide control black						
	Guide control black powder, HB-Set for visibly checking surfaces to be sanded; hand sanding block, 2 guide control black powder cartridges (each 30 g) (495940)	495939	2	41,60	1	508015
	Refillable cartridge, 2 x 30 g refill for the guide control black powder HB set (2 x 30 g)	495940	2	19,50	1	508015
Compressed air orbital sanders						
Compressed orbital sander LRS 400						
	Compressed air orbital sander, LRS 400 Note: an IAS 2/IAS 3 connecting system is required for operation; StickFix sanding pad 80 x 400 mm (soft) (493140), bottle of cleaning and lubricating oil LFC 9022 (50 ml) (201077)	574813	1	681,00	1	108008



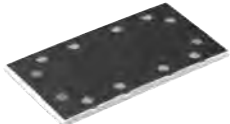

Sanding with compressed air

Denomination and application	Order no.	PU	Trade price € excl. VAT per PU ¹⁾	SU	DG
------------------------------	-----------	----	--	----	----

Accessories for compressed-air sander

Accessories for compressed-air sander					
	Sanding pad, SSH-93x175/8 for RS 300, RS 3, LRS 93; for abrasives for clamping dimensions 93 x 175 mm	489630	1	28,90	1 408004
	Sanding pad, SSH-STF-93x175/8 for RS 300, RS 3, LRS 93; StickFix adhesive layer for quick change of sanding pad dimensions 93 x 175 mm	483905	1	33,00	1 408004
	Iron sanding pad, SSH-STF-V93x266/14 for RS 300, RS 3, LRS 93; StickFix; pressing iron sanding pad version dimensions 93 x 266 mm	486418	1	47,30	1 408004
	Sanding pad, SSH-STF-80x400/17 for LRS 400, HSK 80 x 400, HSK 80 x 200; soft dimensions 80 x 400 mm	493140	1	72,00	1 408004

Accessories for sanding with compressed air



Air tool connections					
	Air hose, D 12,4 x 5 m for LEX 3, LEX 2, LRS, IAS 3-SD; the IAS 3-SD adapter is necessary for connection to the machine length 5 m	497215	1	66,80	1 208008
	IAS adapter, IAS 3-SD for LEX 3, LEX 2, LRS; for connecting a Festool compressed air sander directly to a compressed air line (without dust extraction) length 90 mm	497214	1	78,30	1 208008
	Adapter, IAS-ZA for central extraction units, boom arms manufactured by Rupes, IVO and Herkules, and Rupes power boxes; rubber bushing for connection of IAS 2/IAS 3 air tools via an IAS 2/IAS 3 connection; exterior Ø 59/75 mm; interior Ø 49/57 mm	489222	1	65,10	1 208008
	IAS adapter, IAS-S-ZA/Herkules for connection of IAS 2/IAS 3 suction hoses to Herkules central suction system; with closing slide	490605	1	134,70	1 208008

* Attention: Festool products with Bluetooth® technology are not available in all countries.
 For more information, please contact the official local Festool import partner.
 You can find the overview regarding our products and our partners worldwide on our website www.festool.com

PU = Packaging Units
 SU = Shipping Units

¹⁾ Manufacturer's recommended retail price.
 Dealer prices may vary.

Sanding with compressed air

Denomination and application	Order no.	PU	Trade price		
			€ excl. VAT	SU	DG
			per PU ¹⁾		
 <p>IAS double adapter, IAS 3-DA-CT for LEX 3, LEX 2, LRS, CT extractor (not CT 11/MINI/MIDI); for simultaneously connecting two air tools with IAS 2 and/or IAS 3 adapter to a Festool dust extractor; Not suitable for M dust extractor</p>	497284	1	88,10	1	208008
 <p>Adapter, IAS 3-FA for LEX 3, LEX 2, LRS; for connecting an IAS 3 or IAS 3 light hose to an EAA power box or Herkules exhaust turbine sleeve diameter 47,5 - 51,8 mm</p>	499025	1	31,60	1	208008

Air tool connections IAS 3 light

2-in-1 function: Dust extraction and compressed air in a single hose (Ø 37 mm)



 <p>IAS hose light, IAS 3 light 3500 AS for LEX 3, LEX 2, LRS; antistatic; in accordance with DIN IEC 312; for connecting a Festool compressed air sander to a Festool mobile dust extractor or energy box length 3,5 m; bleeder resistor (DIN IEC 312) <1 MΩ/m; temperature-resistant up to +70 °C; hose dia. 37 mm</p>	497478	1	240,60	1	208008
<p>IAS hose light, IAS 3 light 5000 AS for LEX 3, LEX 2, LRS; antistatic; in accordance with DIN IEC 312; for connecting a Festool compressed air sander to a Festool mobile dust extractor or energy box length 5 m; bleeder resistor (DIN IEC 312) <1 MΩ/m; temperature-resistant up to +70 °C; hose dia. 37 mm</p>	497213	1	283,60	1	208008
<p>IAS hose light, IAS 3 light 7000 AS for LEX 3, LEX 2, LRS; antistatic; in accordance with DIN IEC 312; for connecting a Festool compressed air sander to a Festool mobile dust extractor or energy box length 7 m; bleeder resistor (DIN IEC 312) <1 MΩ/m; temperature-resistant up to +70 °C; hose dia. 37 mm</p>	497479	1	345,20	1	208008
<p>IAS hose light, IAS 3 light 10000 AS for LEX 3, LEX 2, LRS; antistatic; note: not with combination of CT/SR and ASA; in accordance with DIN IEC 312; for connecting a Festool compressed air sander to a Festool energy box length 10 m; bleeder resistor (DIN IEC 312) <1 MΩ/m; temperature-resistant up to +70 °C; hose dia. 37 mm</p>	497480	1	534,10	1	208008

Air tool connections IAS 3

3-in-1 function: dust extraction and exhaust air in a single hose, Ø 44 mm

 <p>IAS hose, IAS 3-3500 AS for LEX 3, LEX 2, LRS; antistatic; in accordance with DIN IEC 312; for connecting a Festool compressed air sander to a Festool mobile dust extractor or energy box length 3,5 m; bleeder resistor (DIN IEC 312) <1 MΩ/m; temperature-resistant up to +70 °C; hose dia. 44 mm</p>	497208	1	274,90	1	208008
<p>IAS hose, IAS 3-5000 AS for LEX 3, LEX 2, LRS; antistatic; in accordance with DIN IEC 312; for connecting a Festool compressed air sander to a Festool mobile dust extractor or energy box length 5 m; bleeder resistor (DIN IEC 312) <1 MΩ/m; temperature-resistant up to +70 °C; hose dia. 44 mm</p>	497209	1	325,10	1	208008
<p>IAS hose, IAS 3-7000 AS for LEX 3, LEX 2, LRS; antistatic; in accordance with DIN IEC 312; for connecting a Festool compressed air sander to a Festool mobile dust extractor or energy box length 7 m; bleeder resistor (DIN IEC 312) <1 MΩ/m; temperature-resistant up to +70 °C; hose dia. 44 mm</p>	497210	1	419,50	1	208008
<p>IAS hose, IAS 3-10000 AS for LEX 3, LEX 2, LRS; antistatic; in accordance with DIN IEC 312; for connecting a Festool compressed air sander to a Festool energy box length 10 m; bleeder resistor (DIN IEC 312) <1 MΩ/m; temperature-resistant up to +70 °C; hose dia. 44 mm</p>	497211	1	647,50	1	208008

Sanding with compressed air

Denomination and application	Order no.	PU	Trade price € excl. VAT per PU ¹⁾	SU	DG
Compressed air materials					
 <p>Cleaning and lubricating oil, LFC 9022/1000 for LEX, LRS; special oil for compressed air preparation in carton</p>	201076	1	37,30	1	308002
 <p>Cleaning and lubricating oil, LFC 9022/50 for LEX, LRS; special oil for compressed air preparation, 50 ml</p>	201077	1	5,60	1	308002

* Attention: Festool products with Bluetooth® technology are not available in all countries.
For more information, please contact the official local Festool import partner.
You can find the overview regarding our products and our partners worldwide on our website www.festool.com

PU = Packaging Units
SU = Shipping Units

¹⁾ Manufacturer's recommended retail price.
Dealer prices may vary.

Abrasive for long-reach sander

StickFix sanding discs dia. 225 mm for plaster filler and dispersion filler

for the PLANEX LHS 2 225 EQ(I), PLANEX 225 EQ and PLANEX LHS-E 225 easy long-reach sanders; for plaster filler and dispersion-based filler

	Grit	Diameter mm					
STF D225/128 P80 GR/5	P80	225	205665	5	15,40	5	508017
STF D225/128 P120 GR/5	P120	225	205666	5	13,00	5	508017
STF D225/128 P180 GR/5	P180	225	205667	5	13,00	5	508017
STF D225/128 P240 GR/5	P240	225	205668	5	13,00	5	508017
STF D225/128 P320 GR/5	P320	225	205669	5	13,00	5	508017
STF D225/48 P40 GR/25	P40	225	205653	25	60,70	1	508017
STF D225/48 P60 GR/25	P60	225	205654	25	56,60	1	508017
STF D225/128 P80 GR/25	P80	225	205655	25	52,80	1	508017
STF D225/128 P100 GR/25	P100	225	205656	25	45,00	1	508017
STF D225/128 P120 GR/25	P120	225	205657	25	45,00	1	508017
STF D225/128 P150 GR/25	P150	225	205659	25	45,00	1	508017
STF D225/128 P180 GR/25	P180	225	205660	25	45,00	1	508017
STF D225/128 P220 GR/25	P220	225	205662	25	45,00	1	508017
STF D225/128 P240 GR/25	P240	225	205663	25	45,00	1	508017
STF D225/128 P320 GR/25	P320	225	205664	25	45,00	1	508017

Granat



Ø 225

Granat



Ø 225

Granat



Ø 225

StickFix abrasive discs dia. 225 mm with foam backing for plaster filler and dispersion filler

sandpaper on foam backing; in a bag; for the PLANEX 225 EQ and PLANEX LHS-E 225 easy long-reach sanders

	Grit	Diameter mm	Foam height mm					
STF D225 P80 GR S/25	P80	225	3,5	204221	25	113,30	1	508017
STF D225 P100 GR S/25	P100	225	3,5	204222	25	96,50	1	508017
STF D225 P120 GR S/25	P120	225	3,5	204223	25	96,50	1	508017
STF D225 P150 GR S/25	P150	225	3,5	204224	25	96,50	1	508017
STF D225 P180 GR S/25	P180	225	3,5	204225	25	96,50	1	508017
STF D225 P240 GR S/25	P240	225	3,5	204226	25	96,50	1	508017
STF D225 P320 GR S/25	P320	225	3,5	204227	25	96,50	1	508017
STF D225 P400 GR S/25	P400	225	3,5	204228	25	96,50	1	508017

Granat Soft



Ø 225 mm

Abrasives

Denomination and application	Order no.	PU	Trade price € excl. VAT per PU ¹⁾	SU	DG
------------------------------	-----------	----	--	----	----

Abrasive mesh dia. 225 mm for plaster filler and dispersion filler

for the PLANEX LHS 2 225 EQ(I), PLANEX 225 EQ and PLANEX LHS-E 225 easy long-reach sanders



	Grit	Diameter mm					
STF D225 P80 GR NET/25	P80	225	203312	25	75,70	1	508021
STF D225 P100 GR NET/25	P100	225	203313	25	64,60	1	508021
STF D225 P120 GR NET/25	P120	225	203314	25	64,60	1	508021
STF D225 P150 GR NET/25	P150	225	203315	25	64,60	1	508021
STF D225 P180 GR NET/25	P180	225	203316	25	64,60	1	508021
STF D225 P220 GR NET/25	P220	225	203317	25	64,60	1	508021
STF D225 P240 GR NET/25	P240	225	203318	25	64,60	1	508021
STF D225 P320 GR NET/25	P320	225	203319	25	64,60	1	508021
STF D225 P400 GR NET/25	P400	225	201885	25	64,60	1	508021

StickFix sanding discs for heavy-duty applications, Ø 225 mm

for the PLANEX LHS 2 225 EQ(I), PLANEX 225 EQ and PLANEX LHS-E 225 easy long-reach sanders

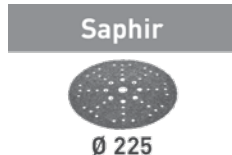

	Grit	Diameter mm					
STF D225/48 P24 SA/25	P24	225	205650	25	124,80	1	508004
STF D225/48 P36 SA/25	P36	225	205652	25	124,80	1	508004

Abrasives for geared eccentric sanders, eccentric sanders and compressed air eccentric sanders

StickFix sanding discs dia. 77 mm for final sanding of paints and minerals

for LEX 3 77

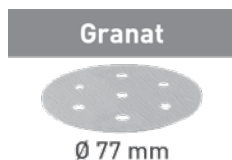

	Grit	Diameter mm					
STF D77/6 P80 GR/50	P80	77	497405	50	27,30	1	508017
STF D77/6 P120 GR/50	P120	77	497406	50	23,20	1	508017
STF D77/6 P150 GR/50	P150	77	497407	50	23,20	1	508017
STF D77/6 P180 GR/50	P180	77	497408	50	23,20	1	508017
STF D77/6 P240 GR/50	P240	77	497409	50	23,20	1	508017
STF D77/6 P280 GR/50	P280	77	497410	50	23,00	1	508017
STF D77/6 P320 GR/50	P320	77	497411	50	23,20	1	508017
STF D77/6 P400 GR/50	P400	77	497412	50	23,20	1	508017
STF D77/6 P500 GR/50	P500	77	497413	50	23,20	1	508017

StickFix sanding discs dia. 77 mm for final sanding of paints and minerals

fine abrasive on material carrier, perforated; for LEX 3 77



	Grit	Diameter mm					
STF D 77/6 P800 GR/50	P800	77	498929	50	44,30	1	508017
STF D 77/6 P1000 GR/50	P1000	77	498930	50	44,30	1	508017
STF D 77/6 P1200 GR/50	P1200	77	498931	50	44,30	1	508017
STF D 77/6 P1500 GR/50	P1500	77	498932	50	44,30	1	508017

* Attention: Festool products with Bluetooth® technology are not available in all countries.
For more information, please contact the official local Festool import partner.
You can find the overview regarding our products and our partners worldwide on our website www.festool.com

PU = Packaging Units
SU = Shipping Units

¹⁾ Manufacturer's recommended retail price.
Dealer prices may vary.

Denomination and application

Order no. PU Trade price
€ excl. VAT SU DG
per PU ¹⁾

StickFix sanding discs, dia. 90 mm for repair compound, fillers, clear coats (specially VOC clear coats and hard under-coats)
for RO 90 DX

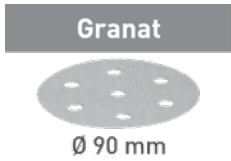

	Grit	Diameter mm					
STF D90/6 P40 GR/50	P40	90	497363	50	32,90	1	508017
STF D90/6 P60 GR/50	P60	90	497364	50	30,70	1	508017
STF D90/6 P80 GR/50	P80	90	497365	50	28,70	1	508017
STF D90/6 P100 GR/100	P100	90	497366	100	48,70	1	508017
STF D90/6 P120 GR/100	P120	90	497367	100	48,70	1	508017
STF D90/6 P150 GR/100	P150	90	497368	100	48,70	1	508017
STF D90/6 P180 GR/100	P180	90	497369	100	48,70	1	508017
STF D90/6 P220 GR/100	P220	90	497370	100	48,70	1	508017
STF D90/6 P240 GR/100	P240	90	497371	100	48,70	1	508017
STF D90/6 P280 GR /100	P280	90	497850	100	48,40	1	508017
STF D90/6 P320 GR/100	P320	90	497372	100	48,70	1	508017
STF D90/6 P400 GR/100	P400	90	497373	100	48,70	1	508017
STF D90/6 P500 GR/100	P500	90	498326	100	48,70	1	508017

StickFix sanding discs Ø 90 mm for final sanding of paints and minerals
fine abrasive on material carrier, perforated; for RO 90 DX

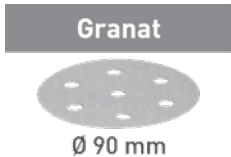

	Grit	Diameter mm					
STF D90/6 P800 GR/50	P800	90	498327	50	46,70	1	508017
STF D90/6 P1000 GR/50	P1000	90	498328	50	46,70	1	508017
STF D90/6 P1200 GR/50	P1200	90	498329	50	46,70	1	508017
STF D90/6 P1500 GR/50	P1500	90	498330	50	46,70	1	508017

StickFix sanding discs for wood, Ø 90 mm
for RO 90 DX

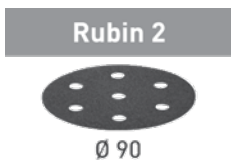



	Grit	Diameter mm					
STF D90/6 P40 RU2/50	P40	90	499077	50	32,90	1	508003
STF D90/6 P60 RU2/50	P60	90	499078	50	30,70	1	508003
STF D90/6 P80 RU2/50	P80	90	499079	50	28,70	1	508003
STF D90/6 P100 RU2/50	P100	90	499080	50	24,50	1	508003
STF D90/6 P120 RU2/50	P120	90	499081	50	24,50	1	508003
STF D90/6 P150 RU2/50	P150	90	499082	50	24,50	1	508003
STF D90/6 P180 RU2/50	P180	90	499083	50	24,50	1	508003
STF D90/6 P220 RU2/50	P220	90	499084	50	24,50	1	508003

Abrasives

Denomination and application	Order no.	PU	Trade price			
			€ excl. VAT	SU	DG	per PU ¹⁾
Stickfix soft sanding discs for extra-fine sanding, Ø 90 mm for RO 90 DX						
			Grit	Diameter mm		
 Platin 2 Ø 90	STF D 90/0 S500 PL2/15		S500	90	498322	15 38,80 1 508005
	STF D 90/0 S1000 PL2/15		S1000	90	498323	15 38,80 1 508005
	STF D 90/0 S2000 PL2/15		S2000	90	498324	15 38,80 1 508005
	STF D 90/0 S4000 PL2/15		S4000	90	498325	15 38,80 1 508005

StickFix abrasive sheets V93 for fillers, clear coats (spec. VOC clear coats and hard undercoats) for RO 90 DX, DX 93 and RS 300, RS 3, LRS 93 (V-shaped sanding pad)						
			Grit			
 Granat 93 V	STF V93/6 P40 GR/50		P40	497390	50 26,40 1 508017	
	STF V93/6 P60 GR/50		P60	497391	50 24,60 1 508017	
	STF V93/6 P80 GR/50		P80	497392	50 23,00 1 508017	
	STF V93/6 P100 GR/100		P100	497393	100 38,80 1 508017	
	STF V93/6 P120 GR/100		P120	497394	100 38,80 1 508017	
	STF V93/6 P150 GR/100		P150	497395	100 38,80 1 508017	
	STF V93/6 P180 GR/100		P180	497396	100 38,80 1 508017	
	STF V93/6 P220 GR /100		P220	497397	100 38,80 1 508017	
	STF V93/6 P240 GR/100		P240	497398	100 38,80 1 508017	
	STF V93/6 P320 GR/100		P320	497399	100 38,80 1 508017	
	STF V93/6 P400 GR/100		P400	497400	100 38,80 1 508017	

V93 StickFix abrasive sheets for wood for RO 90 DX, DX 93 and RS 300, RS 3, LRS 93 (V-shaped sanding pad)						
			Grit			
 Rubin 2 93 V	STF V93/6 P40 RU2/50		P40	499161	50 26,40 1 508003	
	STF V93/6 P60 RU2/50		P60	499162	50 24,60 1 508003	
	STF V93/6 P80 RU2/50		P80	499163	50 23,00 1 508003	
	STF V93/6 P100 RU2/50		P100	499164	50 19,50 1 508003	
	STF V93/6 P120 RU2/50		P120	499165	50 19,50 1 508003	
	STF V93/6 P150 RU2/50		P150	499166	50 19,50 1 508003	
	STF V93/6 P180 RU2/50		P180	499167	50 19,50 1 508003	
	STF V93/6 P220 RU2/50		P220	499168	50 19,50 1 508003	

StickFix sanding discs Ø 125 mm for repair compound, fillers, clear coats (special VOC clear coats and hard undercoats) for RO 125, ES 125, ETS 125, ETSC 125, ETS EC 125, LEX 125						
			Grit	Diameter mm		
 Granat Ø 125	STF D125/8 P40 GR/10		P40	125	497145	10 16,40 5 508017
	STF D125/8 P60 GR/10		P60	125	497146	10 15,20 5 508017
	STF D125/8 P80 GR/10		P80	125	497147	10 14,40 5 508017

* Attention: Festool products with Bluetooth® technology are not available in all countries.
For more information, please contact the official local Festool import partner.
You can find the overview regarding our products and our partners worldwide on our website www.festool.com

PU = Packaging Units
SU = Shipping Units

¹⁾ Manufacturer's recommended retail price.
Dealer prices may vary.

Denomination and application

Order no. PU Trade price
€ excl. VAT SU DG
per PU ¹⁾

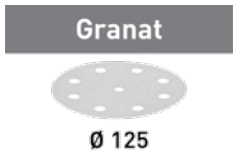

	Grit	Diameter mm					
STF D125/8 P120 GR/10	P120	125	497148	10	12,20	5	508017
STF D125/8 P180 GR/10	P180	125	497149	10	12,20	5	508017
STF D125/8 P320 GR/10	P320	125	497150	10	12,20	5	508017
STF D125/8 P40 GR/50	P40	125	497165	50	50,70	1	508017
STF D125/8 P60 GR/50	P60	125	497166	50	47,30	1	508017
STF D125/8 P80 GR/50	P80	125	497167	50	44,20	1	508017
STF D125/8 P100 GR/100	P100	125	497168	100	75,00	1	508017
STF D125/8 P120 GR/100	P120	125	497169	100	75,00	1	508017
STF D125/8 P150 GR/100	P150	125	497170	100	75,00	1	508017
STF D125/8 P180 GR/100	P180	125	497171	100	75,00	1	508017
STF D125/8 P220 GR/100	P220	125	497172	100	75,00	1	508017
STF D125/8 P240 GR/100	P240	125	497173	100	75,00	1	508017
STF D125/8 P280 GR/100	P280	125	497174	100	74,60	1	508017
STF D125/8 P320 GR/100	P320	125	497175	100	75,00	1	508017
STF D125/8 P360 GR/100	P360	125	497176	100	74,60	1	508017
STF D125/8 P400 GR/100	P400	125	497177	100	75,00	1	508017
STF D125/8 P500 GR/100	P500	125	497178	100	75,00	1	508017

StickFix sanding discs Ø 125 mm for final sanding of paints and minerals

fine abrasive on material carrier, perforated; for RO 125, ES 125, ETS 125, ETSC 125, ETS EC 125, LEX 125



	Grit	Diameter mm					
STF D125/8 P800 GR/50	P800	125	497179	50	71,80	1	508017
STF D125/8 P1000 GR/50	P1000	125	497180	50	71,80	1	508017
STF D125/8 P1200 GR/50	P1200	125	497181	50	71,80	1	508017
STF D125/8 P1500 GR/50	P1500	125	497182	50	71,80	1	508017

Abrasives

Denomination and application

Order no. PU Trade price
€ excl. VAT SU DG
per PU ¹⁾

Abrasive mesh dia. 125 mm for repair compound, filler, paint, varnish and base layers which generally produce a large quantity of dust
for R0 125, ES 125, ETS 125, ETSC 125, ETS EC 125, LEX 125

Granat Net



	Grit	Diameter mm					
STF D125 P80 GR NET/50	P80	125	203294	50	62,80	1	508021
STF D125 P100 GR NET/50	P100	125	203295	50	53,30	1	508021
STF D125 P120 GR NET/50	P120	125	203296	50	53,30	1	508021
STF D125 P150 GR NET/50	P150	125	203297	50	53,30	1	508021
STF D125 P180 GR NET/50	P180	125	203298	50	53,30	1	508021
STF D125 P220 GR NET/50	P220	125	203299	50	53,30	1	508021
STF D125 P240 GR NET/50	P240	125	203300	50	53,30	1	508021
STF D125 P320 GR NET/50	P320	125	203301	50	53,30	1	508021
STF D125 P400 GR NET/50	P400	125	203302	50	53,30	1	508021

Protection pad

for protecting the sanding pad when using abrasive net; for R0 125, ES 125, ETS 125, ETSC 125, ETS EC 125, LEX 125

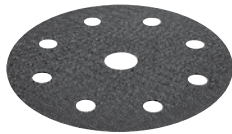

	Diameter mm	Height mm					
PP-STF D125 /2	125	2	203344	2	10,20	1	408006

StickFix sanding discs for wood, Ø 125 mm

for R0 125, ES 125, ETS 125, ETSC 125, ETS EC 125, LEX 125

Rubin 2

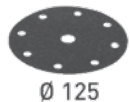

	Grit	Diameter mm					
STF D125/8 P40 RU2/10	P40	125	499101	10	16,40	5	508003
STF D125/8 P60 RU2/10	P60	125	499102	10	15,20	5	508003
STF D125/8 P80 RU2/10	P80	125	499103	10	14,40	5	508003
STF D125/8 P100 RU2/10	P100	125	499104	10	12,20	5	508003
STF D125/8 P120 RU2/10	P120	125	499105	10	12,20	5	508003
STF D125/8 P150 RU2/10	P150	125	499106	10	12,20	5	508003
STF D125/8 P180 RU2/10	P180	125	499107	10	12,20	5	508003
STF D125/8 P220 RU2/10	P220	125	499108	10	12,20	5	508003
STF D125/8 P40 RU2/50	P40	125	499093	50	50,70	1	508003
STF D125/8 P60 RU2/50	P60	125	499094	50	47,30	1	508003
STF D125/8 P80 RU2/50	P80	125	499095	50	44,20	1	508003
STF D125/8 P100 RU2/50	P100	125	499096	50	37,60	1	508003
STF D125/8 P120 RU2/50	P120	125	499097	50	37,60	1	508003
STF D125/8 P150 RU2/50	P150	125	499098	50	37,60	1	508003
STF D125/8 P180 RU2/50	P180	125	499099	50	37,60	1	508003
STF D125/8 P220 RU2/50	P220	125	499100	50	37,60	1	508003

* Attention: Festool products with Bluetooth® technology are not available in all countries.
For more information, please contact the official local Festool import partner.
You can find the overview regarding our products and our partners worldwide on our website www.festool.com

PU = Packaging Units
SU = Shipping Units

¹⁾ Manufacturer's recommended retail price.
Dealer prices may vary.

Denomination and application

Order no. PU Trade price € excl. VAT SU DG per PU ¹⁾

StickFix sanding discs for heavy duty operating conditions, Ø 125 mm

for RO 125, ES 125, ETS 125, ETSC 125, ETS EC 125, LEX 125

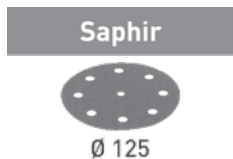

	Grit	Diameter mm					
STF D125/8 P24 SA/25	P24	125	493124	25	42,70	1	508004
STF D125/8 P36 SA/25	P36	125	493125	25	42,70	1	508004
STF D125/8 P50 SA/25	P50	125	493126	25	36,50	1	508004
STF D125/8 P80 SA/25	P80	125	493127	25	36,50	1	508004

StickFix soft sanding discs for extra-fine sanding, Ø 125 mm

for RO 125, ES 125, ETS 125, ETSC 125, ETS EC 125, LEX 125

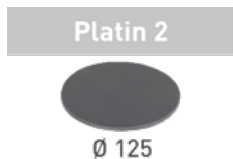

	Grit	Diameter mm					
STF D125/0 S400 PL2/15	S400	125	492373	15	43,60	1	508005
STF D125/0 S500 PL2/15	S500	125	492374	15	43,60	1	508005
STF D125/0 S1000 PL2/15	S1000	125	492375	15	43,60	1	508005
STF D125/0 S2000 PL2/15	S2000	125	492376	15	44,80	1	508005
STF D125/0 S4000 PL2/15	S4000	125	492377	15	44,80	1	508005

StickFix sanding discs for light sanding, Ø 125 mm

for RO 125, ES 125, ETS 125, ETSC 125, ETS EC 125, LEX 125



	Grit	Diameter mm					
STF D125 MD 100 VL/10	MEDIUM 100	125	201131	10	33,90	1	508006
STF D125 FN 320 VL/10	FINE 320	125	201132	10	32,20	1	508006
STF D125 SF 800 VL/10	SUPER-FINE 800	125	201133	10	32,20	1	508006

StickFix special fleece Ø 125 mm for oiling and waxing



	Grit	Diameter mm					
STF D125 green VL/10 for RO 125, ES 125, ETS 125, ETSC 125, ETS EC 125, LEX 125; green; Oil worked into the surface deep and evenly	green	125	496510	10	30,70	1	508006
STF D125 white VL/10 for RO 125, ES 125, ETS 125, ETSC 125, ETS EC 125, LEX 125; white; Even distribution and polishing of oil and wax for further surface refinement; Non-abrasive polishing without grit	white	125	496511	10	30,70	1	508006

StickFix sanding discs, Ø 150 mm for repair compound, fillers, clear coats (special VOC clear coats)

MULTI-JETSTREAM 2; for RO 150, ES 150, ETS 150, ETS EC 150, LEX 150, WTS 150, HSK-D 150

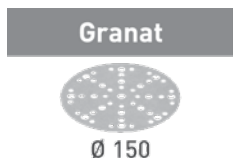

	Grit	Diameter mm					
STF D150/48 P40 GR/10	P40	150	575154	10	17,90	5	508017
STF D150/48 P60 GR/10	P60	150	575155	10	16,80	5	508017
STF D150/48 P80 GR/10	P80	150	575156	10	15,60	5	508017
STF D150/48 P120 GR/10	P120	150	575157	10	13,20	5	508017

* Attention: Festool products with Bluetooth® technology are not available in all countries.
For more information, please contact the official local Festool import partner.
You can find the overview regarding our products and our partners worldwide on our website www.festool.com

PU = Packaging Units
SU = Shipping Units

¹⁾ Manufacturer's recommended retail price.
Dealer prices may vary.

Abrasives

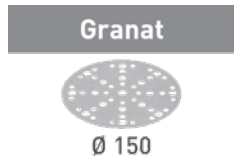

Denomination and application	Grit	Diameter mm	Trade price				
			Order no.	PU	€ excl. VAT per PU ¹⁾	SU	DG
STF D150/48 P180 GR/10	P180	150	575158	10	13,20	5	508017
STF D150/48 P320 GR/10	P320	150	575159	10	13,20	5	508017
STF D150/48 P40 GR/50	P40	150	575160	50	55,70	1	508017
STF D150/48 P60 GR/50	P60	150	575161	50	52,10	1	508017
STF D150/48 P80 GR/50	P80	150	575162	50	48,50	1	508017
STF D150/48 P100 GR/100	P100	150	575163	100	82,30	1	508017
STF D150/48 P120 GR/100	P120	150	575164	100	82,30	1	508017
STF D150/48 P150 GR/100	P150	150	575165	100	82,30	1	508017
STF D150/48 P180 GR/100	P180	150	575166	100	82,30	1	508017
STF D150/48 P220 GR/100	P220	150	575167	100	82,30	1	508017
STF D150/48 P240 GR/100	P240	150	575168	100	82,30	1	508017
STF D150/48 P280 GR/100	P280	150	575169	100	81,90	1	508017
STF D150/48 P320 GR/100	P320	150	575170	100	82,30	1	508017
STF D150/48 P360 GR/100	P360	150	575171	100	81,90	1	508017
STF D150/48 P400 GR/100	P400	150	575172	100	82,30	1	508017
STF D150/48 P500 GR/100	P500	150	575173	100	82,30	1	508017
STF D150/48 P800 GR/50	P800	150	575174	50	79,00	1	508017
STF D150/48 P1000 GR/50	P1000	150	575175	50	79,00	1	508017
STF D150/48 P1200 GR/50	P1200	150	575176	50	79,00	1	508017
STF D150/48 P1500 GR/50	P1500	150	575177	50	79,00	1	508017

Abrasive mesh dia. 150 mm for repair compound, filler, paint, varnish and base layers which generally produce a large quantity of dust

for RO 150, ES 150, ETS 150, ETS EC 150, LEX 150, WTS 150, HSK-D 150



Denomination and application	Grit	Diameter mm	Trade price				
			Order no.	PU	€ excl. VAT per PU ¹⁾	SU	DG
STF D150 P80 GR NET/50	P80	150	203303	50	68,80	1	508021
STF D150 P100 GR NET/50	P100	150	203304	50	58,50	1	508021
STF D150 P120 GR NET/50	P120	150	203305	50	58,50	1	508021
STF D150 P150 GR NET/50	P150	150	203306	50	58,50	1	508021
STF D150 P180 GR NET/50	P180	150	203307	50	58,50	1	508021
STF D150 P220 GR NET/50	P220	150	203308	50	58,50	1	508021
STF D150 P240 GR NET/50	P240	150	203309	50	58,50	1	508021
STF D150 P320 GR NET/50	P320	150	203310	50	58,50	1	508021
STF D150 P400 GR NET/50	P400	150	203311	50	58,50	1	508021

* Attention: Festool products with Bluetooth® technology are not available in all countries. For more information, please contact the official local Festool import partner. You can find the overview regarding our products and our partners worldwide on our website www.festool.com

PU = Packaging Units
SU = Shipping Units

¹⁾ Manufacturer's recommended retail price. Dealer prices may vary.

Denomination and application

Order no. PU Trade price
€ excl. VAT SU DG
per PU ¹⁾

Protection pad

for protecting the sanding pad when using abrasive net; for RO 150, ES 150, ETS 150, ETS EC 150, LEX 150, WTS 150

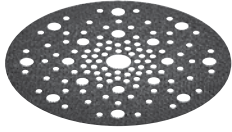

	Diameter mm	Height mm					
PP-STF D150 /2	150	2	203343	2	11,30	1	408006

StickFix sanding discs for wood, Ø 150 mm

MULTI-JETSTREAM 2; for RO 150, ES 150, ETS 150, ETS EC 150, LEX 150, WTS 150, HSK-D 150

Rubin 2

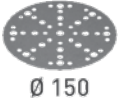

	Grit	Diameter mm					
STF D150/48 P40 RU2/10	P40	150	575178	10	17,90	5	508003
STF D150/48 P60 RU2/10	P60	150	575179	10	16,80	5	508003
STF D150/48 P80 RU2/10	P80	150	575180	10	15,60	5	508003
STF D150/48 P100 RU2/10	P100	150	575181	10	13,20	5	508003
STF D150/48 P120 RU2/10	P120	150	575182	10	13,20	5	508003
STF D150/48 P150 RU2/10	P150	150	575183	10	13,20	5	508003
STF D150/48 P180 RU2/10	P180	150	575184	10	13,20	5	508003
STF D150/48 P220 RU2/10	P220	150	575185	10	13,20	5	508003
STF D150/48 P40 RU2/50	P40	150	575186	50	55,70	1	508003
STF D150/48 P60 RU2/50	P60	150	575187	50	52,10	1	508003
STF D150/48 P80 RU2/50	P80	150	575188	50	48,50	1	508003
STF D150/48 P100 RU2/50	P100	150	575189	50	41,30	1	508003
STF D150/48 P120 RU2/50	P120	150	575190	50	41,30	1	508003
STF D150/48 P150 RU2/50	P150	150	575191	50	41,30	1	508003
STF D150/48 P180 RU2/50	P180	150	575192	50	41,30	1	508003
STF D150/48 P220 RU2/50	P220	150	575193	50	41,30	1	508003

StickFix sanding discs for heavy duty operating conditions, Ø 150 mm



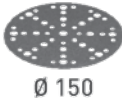

MULTI-JETSTREAM 2; for RO 150, ES 150, ETS 150, ETS EC 150, LEX 150, WTS 150, HSK-D 150

Saphir

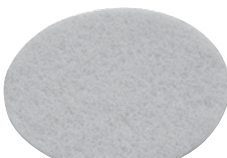

	Grit	Diameter mm					
STF-D150/48 P24 SA/25	P24	150	575194	25	61,20	1	508004
STF-D150/48 P36 SA/25	P36	150	575195	25	61,20	1	508004
STF-D150/48 P50 SA/25	P50	150	575196	25	52,10	1	508004
STF-D150/48 P80 SA/25	P80	150	575197	25	52,10	1	508004

Abrasives

Denomination and application			Order no.	PU	Trade price € excl. VAT per PU ¹⁾	SU	DG	
StickFix soft sanding discs for extra-fine sanding, Ø 150 mm for RO 150, ES 150, ETS 150, ETS EC 150, LEX 150, WTS 150, HSK-D 150								
 <p>Platin 2</p> <p>Ø 150</p>	STF D150/0 S400 PL2/15	Grit	Diameter mm					
		S400	150	492368	15	51,40	1	508005
	STF D150/0 S500 PL2/15	S500	150	492369	15	51,40	1	508005
	STF D150/0 S1000 PL2/15	S1000	150	492370	15	51,40	1	508005
	STF D150/0 S2000 PL2/15	S2000	150	492371	15	52,20	1	508005
	STF D150/0 S4000 PL2/15	S4000	150	492372	15	52,20	1	508005
StickFix sanding discs for light sanding, Ø 150 mm unperforated; for RO 150, ES 150, ETS 150, ETS EC 150, LEX 150, WTS 150, HSK-D 150								
 <p>Vlies</p> <p>Ø 150</p>	STF D150 MD 100 VL/10	Grit	Diameter mm					
		MEDIUM 100	150	201126	10	36,30	1	508006
	STF D150 FN 320 VL/10	FINE 320	150	201127	10	34,50	1	508006
	STF D150 SF 800 VL/10	SUPER- FINE 800	150	201128	10	34,50	1	508006
StickFix special fleece Ø 150 mm for oiling and waxing for RO 150, ES 150, ETS 150, ETS EC 150, LEX 150, WTS 150, HSK-D 150								
 	STF D150 green VL/10	Grit	Diameter mm					
		green	150	496508	10	37,60	1	508006
	STF D150 white VL/10	white	150	496509	10	37,60	1	508006
for RO 150, ES 150, ETS 150, ETS EC 150, LEX 150, WTS 150, HSK-D 150; Oil worked into the surface deep and evenly for RO 150, ES 150, ETS 150, ETS EC 150, LEX 150, WTS 150, HSK-D 150; Even distribution and polishing of oil and wax for further surface refinement; Non-abrasive polishing without grit								
StickFix sanding discs Ø 185 mm for repair compound, fillers, clear coats (special VOC clear coats) for LEX 185								
 <p>Granat</p> <p>Ø 185</p>	STF D185/16 P40 GR/50	Grit	Diameter mm					
		P40	185	497183	50	70,50	1	508017
	STF D185/16 P60 GR/50	P60	185	497184	50	65,50	1	508017
	STF D185/16 P80 GR/50	P80	185	497185	50	61,40	1	508017
	STF D185/16 P100 GR/100	P100	185	499629	100	104,00	1	508017
	STF D185/16 P120 GR/100	P120	185	497186	100	104,00	1	508017
	STF D185/16 P150 GR/100	P150	185	497187	100	104,00	1	508017
	STF D185/16 P180 GR/100	P180	185	497188	100	104,00	1	508017
	STF D185/16 P240 GR/100	P240	185	497189	100	104,00	1	508017
	STF D185/16 P320 GR/100	P320	185	497190	100	104,00	1	508017
	STF D185/16 P400 GR/100	P400	185	497191	100	104,00	1	508017

* Attention: Festool products with Bluetooth® technology are not available in all countries.
 For more information, please contact the official local Festool import partner.
 You can find the overview regarding our products and our partners worldwide on our website www.festool.com

PU = Packaging Units
 SU = Shipping Units

¹⁾ Manufacturer's recommended retail price.
 Dealer prices may vary.

Denomination and application

Order no. PU Trade price
€ excl. VAT SU DG
per PU ¹⁾

Abrasives for orbital sanders, linear sanders and compressed air sanders

StickFix abrasive sheets V93 for fillers, clear coats (spec. VOC clear coats and hard undercoats)
for RO 90 DX, DX 93 and RS 300, RS 3, LRS 93 [V-shaped sanding pad]



	Grit					
STF V93/6 P40 GR/50	P40	497390	50	26,40	1	508017
STF V93/6 P60 GR/50	P60	497391	50	24,60	1	508017
STF V93/6 P80 GR/50	P80	497392	50	23,00	1	508017
STF V93/6 P100 GR/100	P100	497393	100	38,80	1	508017
STF V93/6 P120 GR/100	P120	497394	100	38,80	1	508017
STF V93/6 P150 GR/100	P150	497395	100	38,80	1	508017
STF V93/6 P180 GR/100	P180	497396	100	38,80	1	508017
STF V93/6 P220 GR /100	P220	497397	100	38,80	1	508017
STF V93/6 P240 GR/100	P240	497398	100	38,80	1	508017
STF V93/6 P320 GR/100	P320	497399	100	38,80	1	508017
STF V93/6 P400 GR/100	P400	497400	100	38,80	1	508017

V93 StickFix abrasive sheets for wood
for RO 90 DX, DX 93 and RS 300, RS 3, LRS 93 [V-shaped sanding pad]



	Grit					
STF V93/6 P40 RU2/50	P40	499161	50	26,40	1	508003
STF V93/6 P60 RU2/50	P60	499162	50	24,60	1	508003
STF V93/6 P80 RU2/50	P80	499163	50	23,00	1	508003
STF V93/6 P100 RU2/50	P100	499164	50	19,50	1	508003
STF V93/6 P120 RU2/50	P120	499165	50	19,50	1	508003
STF V93/6 P150 RU2/50	P150	499166	50	19,50	1	508003
STF V93/6 P180 RU2/50	P180	499167	50	19,50	1	508003
STF V93/6 P220 RU2/50	P220	499168	50	19,50	1	508003

StickFix abrasive sheets, 80 x 133 mm for repair compound, fillers, clear coats (special VOC clear coats and hard undercoats)

for RTS 400, RTSC 400, RS 400, RS 4, LS 130, HSK-A 80 x 130, HSK 80 x 133

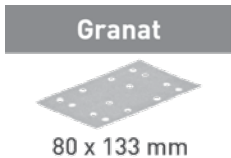

	Grit	Dimensions mm				
STF 80x133 P40 GR/10	P40	80 x 133	497127	10	11,30	5 508017
STF 80x133 P80 GR/10	P80	80 x 133	497128	10	9,90	5 508017
STF 80x133 P120 GR/10	P120	80 x 133	497129	10	8,50	5 508017
STF 80x133 P180 GR/10	P180	80 x 133	497130	10	8,50	5 508017
STF 80x133 P40 GR/50	P40	80 x 133	497117	50	35,00	1 508017
STF 80x133 P60 GR/50	P60	80 x 133	497118	50	32,50	1 508017
STF 80x133 P80 GR/50	P80	80 x 133	497119	50	30,50	1 508017
STF 80x133 P100 GR/100	P100	80 x 133	499628	100	51,50	1 508017
STF 80x133 P120 GR/100	P120	80 x 133	497120	100	51,50	1 508017

* Attention: Festool products with Bluetooth® technology are not available in all countries.
For more information, please contact the official local Festool import partner.
You can find the overview regarding our products and our partners worldwide on our website www.festool.com

PU = Packaging Units
SU = Shipping Units

¹⁾ Manufacturer's recommended retail price.
Dealer prices may vary.

Abrasives

Denomination and application	Order no.	PU	Trade price			
			€ excl. VAT	SU	DG	per PU ¹⁾

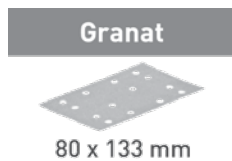

	Grit	Dimensions mm					
STF 80x133 P150 GR/100	P150	80 x 133	497121	100	51,50	1	508017
STF 80x133 P180 GR/100	P180	80 x 133	497122	100	51,50	1	508017
STF 80x133 P220 GR/100	P220	80 x 133	497123	100	51,50	1	508017
STF 80x133 P240 GR/100	P240	80 x 133	497124	100	51,50	1	508017
STF 80x133 P280 GR/100	P280	80 x 133	497204	100	51,20	1	508017
STF 80x133 P320 GR/100	P320	80 x 133	497125	100	51,50	1	508017
STF 80x133 P400 GR/100	P400	80 x 133	497126	100	51,50	1	508017

Abrasive mesh 80 x 133 mm for repair compound, filler, paint, varnish and base layers which generally produce a large quantity of dust
for RTS 400, RTSC 400, RS 400, RS 4, LS 130, HSK-A 80 x 130, HSK 80 x 133



	Grit	Dimensions mm					
STF 80x133 P80 GR NET/50	P80	80 x 133	203285	50	48,50	1	508021
STF 80x133 P100 GR NET/50	P100	80 x 133	203286	50	41,20	1	508021
STF 80x133 P120 GR NET/50	P120	80 x 133	203287	50	41,20	1	508021
STF 80x133 P150 GR NET/50	P150	80 x 133	203288	50	41,20	1	508021
STF 80x133 P180 GR NET/50	P180	80 x 133	203289	50	41,20	1	508021
STF 80x133 P220 GR NET/50	P220	80 x 133	203290	50	41,20	1	508021
STF 80x133 P240 GR NET/50	P240	80 x 133	203291	50	41,20	1	508021
STF 80x133 P320 GR NET/50	P320	80 x 133	203292	50	41,20	1	508021
STF 80x133 P400 GR NET/50	P400	80 x 133	203293	50	41,20	1	508021

Protection pad
for protecting the sanding pad when using abrasive net; for RTS 400, RTSC 400, RS 400, RS 4, LS 130

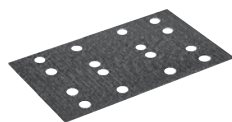

Protection pad, PP-STF 80x133 /2 for RTS 400, RTSC 400, RS 400, RS 4, LS 130 for protecting the sanding pad when using abrasive net dimensions length x width 80 x 133 mm; height 2 mm			203346	2	10,20	1	408006
---	--	--	--------	---	-------	---	--------

StickFix sanding pads for wood, 80 x 133 mm
for RTS 400, RTSC 400, RS 400, RS 4, LS 130, HSK-A 80 x 130, HSK 80 x 133



	Grit	Dimensions mm					
STF 80x133 P40 RU2/10	P40	80 x 133	499054	10	11,20	5	508003
STF 80x133 P60 RU2/10	P60	80 x 133	499055	10	10,50	5	508003
STF 80x133 P80 RU2/10	P80	80 x 133	499056	10	9,80	5	508003
STF 80x133 P100 RU2/10	P100	80 x 133	499057	10	8,40	5	508003
STF 80x133 P120 RU2/10	P120	80 x 133	499058	10	8,40	5	508003
STF 80x133 P150 RU2/10	P150	80 x 133	499059	10	8,40	5	508003
STF 80x133 P180 RU2/10	P180	80 x 133	499060	10	8,40	5	508003
STF 80x133 P220 RU2/10	P220	80 x 133	499061	10	8,40	5	508003
STF 80x133 P40 RU2/50	P40	80 x 133	499046	50	35,00	1	508003

* Attention: Festool products with Bluetooth® technology are not available in all countries.
For more information, please contact the official local Festool import partner.
You can find the overview regarding our products and our partners worldwide on our website www.festool.com

PU = Packaging Units
SU = Shipping Units

¹⁾ Manufacturer's recommended retail price.
Dealer prices may vary.

Denomination and application

Order no. PU Trade price
€ excl. VAT SU DG
per PU ¹⁾



	Grit	Dimensions mm					
STF 80X133 P60 RU2/50	P60	80 x 133	499047	50	32,50	1	508003
STF 80X133 P80 RU2/50	P80	80 x 133	499048	50	30,50	1	508003
STF 80X133 P100 RU2/50	P100	80 x 133	499049	50	26,00	1	508003
STF 80X133 P120 RU2/50	P120	80 x 133	499050	50	26,00	1	508003
STF 80X133 P150 RU2/50	P150	80 x 133	499051	50	26,00	1	508003
STF 80X133 P180 RU2/50	P180	80 x 133	499052	50	26,00	1	508003
STF 80X133 P220 RU2/50	P220	80 x 133	499053	50	26,00	1	508003

80 x 130 mm StickFix abrasive sheet for sanding

for light sanding; for RTS 400, RTSC 400, RS 400, RS 4, LS 130, HSK-A 80 x 130, HSK 80 x 133



	Grit	Dimensions mm					
STF 80x130 SF 800 VL/5	800	80 x 130	483582	5	9,80	1	508006

StickFix abrasive sheets, 80 x 400 mm for repair compound, fillers, clear coats (special VOC clear coats)

for LRS 400, HSK-A 80x400 / 80x200

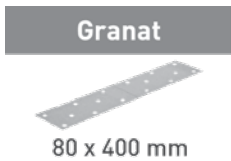

	Grit	Dimensions mm					
STF 80x400 P40 GR/50	P40	80 x 400	497157	50	72,60	1	508017
STF 80x400 P60 GR/50	P60	80 x 400	497158	50	67,50	1	508017
STF 80x400 P80 GR/50	P80	80 x 400	497159	50	63,00	1	508017
STF 80x400 P100 GR/50	P100	80 x 400	499631	50	53,60	1	508017
STF 80x400 P120 GR/50	P120	80 x 400	497160	50	53,60	1	508017
STF 80x400 P150 GR/50	P150	80 x 400	497161	50	53,60	1	508017
STF 80x400 P180 GR/50	P180	80 x 400	497162	50	53,60	1	508017
STF 80x400 P240 GR/50	P240	80 x 400	497163	50	53,60	1	508017
STF 80x400 P280 GR/50	P280	80 x 400	497203	50	53,30	1	508017
STF 80x400 P320 GR/50	P320	80 x 400	497164	50	53,30	1	508017

StickFix abrasive sheets 93 x 178 mm for repair compound, fillers, clear coats (especially VOC clear coats and hard undercoats)

for RS 300, RS 3, LRS 93

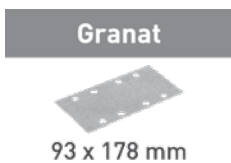

	Grit	Dimensions mm					
STF 93X178 P40 GR/50	P40	93 x 178	498933	50	45,90	1	508017
STF 93X178 P60 GR/50	P60	93 x 178	498934	50	42,60	1	508017
STF 93X178 P80 GR/50	P80	93 x 178	498935	50	39,70	1	508017
STF 93X178 P100 GR/100	P100	93 x 178	499633	100	67,60	1	508017
STF 93X178 P120 GR/100	P120	93 x 178	498936	100	67,60	1	508017
STF 93X178 P150 GR/100	P150	93 x 178	498937	100	67,60	1	508017
STF 93X178 P180 GR/100	P180	93 x 178	498938	100	67,60	1	508017

Abrasives

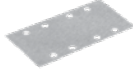
Denomination and application	Grit	Dimensions mm	Order no.	PU	Trade price			DG
					€ excl. VAT	SU	per PU ¹⁾	
  93 x 178 mm	STF 93X178 P220 GR/100	P220	93 x 178	498939	100	67,60	1	508017
	STF 93X178 P240 GR/100	P240	93 x 178	498940	100	67,60	1	508017
	STF 93X178 P280 GR/100	P280	93 x 178	498941	100	67,20	1	508017
	STF 93X178 P320 GR/100	P320	93 x 178	498942	100	67,20	1	508017
	STF 93X178 P400 GR/100	P400	93 x 178	498943	100	67,20	1	508017

StickFix sanding sheets for wood, 93 x 178 mm
for RS 300, RS 3, LRS 93

Denomination and application	Grit	Dimensions mm	Order no.	PU	€ excl. VAT	SU	DG
STF 93X178/8 P60 RU2/50	P60	93 x 178	499062	50	42,60	1	508003
STF 93X178/8 P80 RU2/50	P80	93 x 178	499063	50	39,70	1	508003
STF 93X178/8 P100 RU2/50	P100	93 x 178	499064	50	33,70	1	508003
STF 93X178/8 P120 RU2/50	P120	93 x 178	499065	50	33,70	1	508003
STF 93X178/8 P150 RU2/50	P150	93 x 178	499066	50	33,70	1	508003
STF 93X178/8 P180 RU2/50	P180	93 x 178	499067	50	33,70	1	508003
STF 93X178/8 P220 RU2/50	P220	93 x 178	499068	50	33,70	1	508003

StickFix abrasive sheets 100x150 mm for repair compound, fillers, clear coats (special VOC clear coats and hard undercoats)
for DTS 400, DS 400, DTSC 400

Denomination and application	Grit	Order no.	PU	€ excl. VAT	SU	DG
STF DELTA/7 P80 GR/10	P80	497132	10	11,90	5	508017
STF DELTA/7 P120 GR/10	P120	497133	10	10,00	5	508017
STF DELTA/7 P180 GR/10	P180	497134	10	10,00	5	508017
STF DELTA/7 P40 GR/50	P40	497135	50	41,90	1	508017
STF DELTA/7 P60 GR/50	P60	497136	50	39,00	1	508017
STF DELTA/7 P80 GR/50	P80	497137	50	36,50	1	508017
STF DELTA/7 P100 GR/100	P100	499630	100	61,90	1	508017
STF DELTA/7 P120 GR/100	P120	497138	100	61,90	1	508017
STF DELTA/7 P150 GR/100	P150	497139	100	61,90	1	508017
STF DELTA/7 P180 GR/100	P180	497140	100	61,90	1	508017
STF DELTA/7 P220 GR/100	P220	497141	100	61,90	1	508017
STF DELTA/7 P240 GR/100	P240	497142	100	61,90	1	508017
STF DELTA/7 P320 GR/100	P320	497143	100	61,90	1	508017
STF DELTA/7 P400 GR/100	P400	497144	100	61,90	1	508017

* Attention: Festool products with Bluetooth® technology are not available in all countries.
For more information, please contact the official local Festool import partner.
You can find the overview regarding our products and our partners worldwide on our website www.festool.com

PU = Packaging Units
SU = Shipping Units

¹⁾ Manufacturer's recommended retail price.
Dealer prices may vary.

Denomination and application

Order no. PU Trade price
€ excl. VAT SU DG
per PU ¹⁾

Abrasive mesh 100 x 150 mm for repair compound, filler, paint, varnish and base layers which generally produce a large quantity of dust
for DTS 400, DS 400, DTSC 400

Granat Net

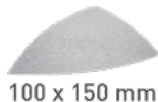

100 x 150 mm

	Grit					
STF DELTA P80 GR NET/50	P80	203320	50	56,90	1	508021
STF DELTA P100 GR NET/50	P100	203321	50	48,40	1	508021
STF DELTA P120 GR NET/50	P120	203322	50	48,40	1	508021
STF DELTA P150 GR NET/50	P150	203323	50	48,40	1	508021
STF DELTA P180 GR NET/50	P180	203324	50	48,40	1	508021
STF DELTA P220 GR NET/50	P220	203325	50	48,40	1	508021
STF DELTA P240 GR NET/50	P240	203326	50	48,40	1	508021
STF DELTA P320 GR NET/50	P320	203327	50	48,40	1	508021
STF DELTA P400 GR NET/50	P400	203328	50	48,40	1	508021

Protection pad

for protecting the sanding pad when using abrasive net; for DTS 400, DTSC 400, DS 400

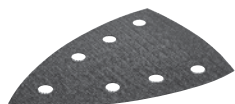

	Dimensions length x width mm	Height mm				
PP-STF DELTA /2	100 x 150	2	203347	2	10,20	408006

StickFix abrasive sheets for wood, 100 x 150 mm

for DTS 400, DS 400, DTSC 400

Rubin 2



100 x 150 mm

	Grit					
STF DELTA/7 P40 RU2/10	P40	499141	10	13,50	5	508003
STF DELTA/7 P60 RU2/10	P60	499142	10	12,50	5	508003
STF DELTA/7 P80 RU2/10	P80	499143	10	11,80	5	508003
STF DELTA/7 P100 RU2/10	P100	499144	10	9,90	5	508003
STF DELTA/7 P120 RU2/10	P120	499145	10	9,90	5	508003
STF DELTA/7 P150 RU2/10	P150	499146	10	9,90	5	508003
STF DELTA/7 P180 RU2/10	P180	499147	10	9,90	5	508003
STF DELTA/7 P220 RU2/10	P220	499148	10	9,90	5	508003
STF DELTA/7 P40 RU2/50	P40	499133	50	41,90	1	508003
STF DELTA/7 P60 RU2/50	P60	499134	50	39,00	1	508003
STF DELTA/7 P80 RU2/50	P80	499135	50	36,50	1	508003
STF DELTA/7 P100 RU2/50	P100	499136	50	31,10	1	508003
STF DELTA/7 P120 RU2/50	P120	499137	50	31,10	1	508003
STF DELTA/7 P150 RU2/50	P150	499138	50	31,10	1	508003
STF DELTA/7 P180 RU2/50	P180	499139	50	31,10	1	508003
STF DELTA/7 P220 RU2/50	P220	499140	50	31,10	1	508003

Abrasives

Denomination and application

Order no. PU Trade price
€ excl. VAT SU DG
per PU ¹⁾

StickFix abrasive sheets 115 x 228 mm for repair compound, fillers, clear coats (especially VOC clear coats and hard undercoats)

for RS 200, RS 2, RS 100, RS 100 C, RS 1, RS 1 C, HSK-A 115 x 226

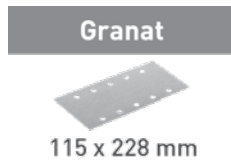

	Grit	Dimensions mm					
STF 115X228 P40 GR/50	P40	115 x 228	498944	50	63,70	1	508017
STF 115X228 P60 GR/50	P60	115 x 228	498945	50	59,20	1	508017
STF 115X228 P80 GR/50	P80	115 x 228	498946	50	55,30	1	508017
STF 115x228 P100 GR/100	P100	115 x 228	499632	100	94,00	1	508017
STF 115X228 P120 GR/100	P120	115 x 228	498947	100	94,00	1	508017
STF 115X228 P150 GR/100	P150	115 x 228	498948	100	94,00	1	508017
STF 115X228 P180 GR/100	P180	115 x 228	498949	100	94,00	1	508017
STF 115X228 P220 GR/100	P220	115 x 228	498950	100	94,00	1	508017
STF 115X228 P240 GR/100	P240	115 x 228	498951	100	94,00	1	508017
STF 115X228 P320 GR/100	P320	115 x 228	498953	100	94,00	1	508017
STF 115X228 P400 GR/100	P400	115 x 228	498954	100	94,00	1	508017

StickFix sanding sheets for wood, 115 x 228 mm

for RS 200, RS 2, RS 100, RS 100 C, RS 1, RS 1 C, HSK-A 115 x 226



	Grit	Dimensions mm					
STF 115X228 P40 RU2/50	P40	115 x 228	499030	50	63,70	1	508003
STF 115X228 P60 RU2/50	P60	115 x 228	499031	50	59,20	1	508003
STF 115X228 P80 RU2/50	P80	115 x 228	499032	50	55,30	1	508003
STF 115X228 P100 RU2/50	P100	115 x 228	499033	50	47,10	1	508003
STF 115X228 P120 RU2/50	P120	115 x 228	499034	50	47,10	1	508003
STF 115X228 P150 RU2/50	P150	115 x 228	499035	50	47,10	1	508003
STF 115X228 P180 RU2/50	P180	115 x 228	499036	50	47,10	1	508003
STF 115X228 P220 RU2/50	P220	115 x 228	499037	50	47,10	1	508003

Abrasives for rotary sander

StickFix sanding discs for wood, Ø 115 mm

unperforated; for RAS 115



	Grit						
STF D115 P40 RU2/50	P40	499085	50	48,60	1	508003	
STF D115 P60 RU2/50	P60	499086	50	45,20	1	508003	
STF D115 P80 RU2/50	P80	499087	50	42,30	1	508003	
STF D115 P100 RU2/50	P100	499088	50	35,90	1	508003	
STF D115 P120 RU2/50	P120	499089	50	35,90	1	508003	

* Attention: Festool products with Bluetooth® technology are not available in all countries.
For more information, please contact the official local Festool import partner.
You can find the overview regarding our products and our partners worldwide on our website www.festool.com

PU = Packaging Units
SU = Shipping Units

¹⁾ Manufacturer's recommended retail price.
Dealer prices may vary.

Abrasives

Denomination and application

Order no. PU Trade price
€ excl. VAT SU DG
per PU ¹⁾

StickFix sanding discs for heavy duty operating conditions, Ø 115 mm
unperforated; for RAS 115



	Grit					
STF D115/0 P24 SA/25	P24	484151	25	49,00	1	508004
STF D115/0 P36 SA/25	P36	484152	25	49,00	1	508004
STF D115/0 P50 SA/25	P50	485245	25	41,90	1	508004
STF D115/0 P80 SA/25	P80	485246	25	41,90	1	508004

StickFix sanding discs for wood, Ø 180 mm
unperforated; for RAS 180



	Grit					
STF D180/0 P40 RU2/50	P40	499125	50	70,90	1	508003
STF D180/0 P60 RU2/50	P60	499126	50	65,90	1	508003
STF D180/0 P80 RU2/50	P80	499127	50	61,70	1	508003
STF D180/0 P100 RU2/50	P100	499128	50	52,50	1	508003
STF D180/0 P120 RU2/50	P120	499129	50	52,50	1	508003
STF D180/0 P150 RU2/50	P150	499130	50	52,50	1	508003
STF D180/0 P180 RU2/50	P180	499131	50	52,50	1	508003
STF D180/0 P220 RU2/50	P220	499132	50	52,50	1	508003

StickFix sanding discs for heavy duty operating conditions, Ø 180 mm
unperforated; for RAS 180

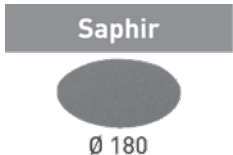

	Grit					
STF D180/0 P24 SA/25	P24	485239	25	102,90	1	508004
STF D180/0 P36 SA/25	P36	485240	25	102,90	1	508004
STF D180/0 P50 SA/25	P50	485241	25	87,60	1	508004
STF D180/0 P80 SA/25	P80	485242	25	87,60	1	508004

Abrasive material for belt sanders

Sanding belts BS75
for BS 75; for wood



	Grit	Dimensions mm				
L533X 75-P40 RU2/10	P40	533 x 75	499155	10	30,90	508003
L533X 75-P60 RU2/10	P60	533 x 75	499156	10	28,80	508003
L533X 75-P80 RU2/10	P80	533 x 75	499157	10	27,00	508003
L533X 75-P100 RU2/10	P100	533 x 75	499158	10	23,00	508003
L533X 75-P120 RU2/10	P120	533 x 75	499159	10	23,00	508003
L533X 75-P150 RU2/10	P150	533 x 75	499160	10	23,00	508003

* Attention: Festool products with Bluetooth® technology are not available in all countries.
For more information, please contact the official local Festool import partner.
You can find the overview regarding our products and our partners worldwide on our website www.festool.com

PU = Packaging Units
SU = Shipping Units

¹⁾ Manufacturer's recommended retail price.
Dealer prices may vary.

Abrasives

Denomination and application	Order no.	PU	Trade price					
			€ excl. VAT	SU	DG	per PU ¹⁾		
Sanding belts BS 105 for BS 105; for wood								
 <p>Rubin 2 620 x 105 mm</p>	L620X105-P40 RU2/10	P40	620 x 105	499149	10	40,30	1	508003
	L620X105-P60 RU2/10	P60	620 x 105	499150	10	37,50	1	508003
	L620X105-P80 RU2/10	P80	620 x 105	499151	10	35,00	1	508003
	L620X105-P100 RU2/10	P100	620 x 105	499152	10	29,90	1	508003
	L620X105-P120 RU2/10	P120	620 x 105	499153	10	29,90	1	508003
	L620X105-P150 RU2/10	P150	620 x 105	499154	10	29,90	1	508003

Abrasives for CMB and CMS-BS 120

CMB 120 and CMS-BS 120 sanding belts sanding belt Saphir CMB 120; for CMB 120								
	Dimensions mm	Grit						
 <p>Saphir 820 x 120 mm</p>	820x120-P50-SA/10	80 x 120	P50	488081	10	86,20	1	508004
	820x120-P80-SA/10	80 x 120	P80	488082	10	86,20	1	508004
	820x120-P100-SA/10	80 x 120	P100	488083	10	76,60	1	508004
	820x120-P120-SA/10	80 x 120	P120	488084	10	76,60	1	508004
	820x120-P150-SA/10	80 x 120	P150	488085	10	76,60	1	508004
	820x120-P180-SA/10	80 x 120	P180	488086	10	76,60	1	508004

Hand sanding blocks and abrasives

Hand abrasive Granat abrasive roll 115 mm x 25 m flexible, universal hand abrasive for paints, repair compounds, fillers, clear coats (especially VOC clear coat and hard undercoats); Dimensions: 115 mm x 25 m								
	Grit							
 <p>Granat 115 mm x 25 m</p>	115x25m P40 GR	P40	201103	1	51,10	3	508020	
	115x25m P60 GR	P60	201104	1	45,40	3	508020	
	115x25m P80 GR	P80	201105	1	42,60	3	508020	
	115x25m P100 GR	P100	201106	1	39,10	3	508020	
	115x25m P120 GR	P120	201107	1	39,10	3	508020	
	115x25m P150 GR	P150	201108	1	39,10	3	508020	
	115x25m P180 GR	P180	201109	1	39,10	3	508020	
	115x25m P220 GR	P220	201110	1	39,10	3	508020	
	115x25m P240 GR	P240	201111	1	39,10	3	508020	
	115x25m P320 GR	P320	201768	1	38,90	3	508020	

Manual abrasive Granat Soft abrasive roll (pre-perforated) 115 mm x 25 m for sanding curves, contours and profiles; for paint repair work; equivalent to approx. 200 soft pads 115x120; on foam backing material								
	Grit							
	115x25m P120 GR SOFT	P120	497091	1	83,20	1	508017	
	115x25m P150 GR SOFT	P150	497092	1	83,20	1	508017	
	115x25m P180 GR SOFT	P180	497093	1	83,20	1	508017	

* Attention: Festool products with Bluetooth® technology are not available in all countries.
For more information, please contact the official local Festool import partner.
You can find the overview regarding our products and our partners worldwide on our website www.festool.com

PU = Packaging Units
SU = Shipping Units

¹⁾ Manufacturer's recommended retail price.
Dealer prices may vary.

Denomination and application

Order no. PU Trade price
€ excl. VAT SU DG
per PU ¹⁾



	Grit					
115x25m P240 GR SOFT	P240	497094	1	83,20	1	508017
115x25m P320 GR SOFT	P320	497095	1	83,20	1	508017
115x25m P400 GR SOFT	P400	497096	1	83,20	1	508017
115x25m P500 GR SOFT	P500	497097	1	83,20	1	508017
115x25m P600 GR SOFT	P600	497098	1	83,20	1	508017
115x25m P800 GR SOFT	P800	497964	1	83,20	1	508017

Hand abrasive Granat sandpaper 230 x 280 mm

flexible, universal hand abrasive for paints, repair compounds, fillers, clear coats (especially VOC clear coat and hard undercoats); dimensions: 230 x 280 mm

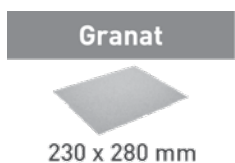

	Grit	Dimensions mm					
230x280 P40 GR/10	P40	230 x 280	201256	10	14,60	15	508020
230x280 P60 GR/10	P60	230 x 280	201257	10	12,60	15	508020
230x280 P80 GR/10	P80	230 x 280	201258	10	11,60	15	508020
230x280 P100 GR/10	P100	230 x 280	201259	10	10,80	15	508020
230x280 P120 GR/10	P120	230 x 280	201260	10	10,80	15	508020
230x280 P150 GR/10	P150	230 x 280	201261	10	10,80	15	508020
230x280 P180 GR/10	P180	230 x 280	201262	10	10,80	15	508020
230x280 P220 GR/10	P220	230 x 280	201263	10	10,80	15	508020
230x280 P240 GR/10	P240	230 x 280	201264	10	10,80	15	508020
230x280 P320 GR/10	P320	230 x 280	201265	10	10,80	15	508020
230x280 P400 GR/10	P400	230 x 280	201266	10	10,80	15	508020
230x280 P60 GR/50	P60	-	201087	50	38,90	3	508020
230x280 P240 GR/50	P240	-	201095	50	33,00	3	508020

Granat sanding block manual abrasive, 69 x 98 x 26 mm

four-sided, rigid abrasive sponge; ideal for sanding edges and profiles; dimensions: 69 x 98 x 26 mm

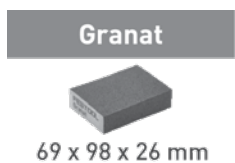

	Grit	Dimensions mm					
69x98x26 36 GR/6	36	69 x 98 x 26	201080	6	5,20	8	508020
69x98x26 60 GR/6	60	69 x 98 x 26	201081	6	5,20	8	508020
69x98x26 120 GR/6	120	69 x 98 x 26	201082	6	5,20	8	508020
69x98x26 220 GR/6	220	69 x 98 x 26	201083	6	5,20	8	508020

Abrasives

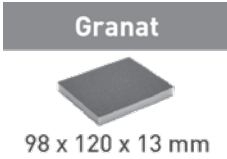
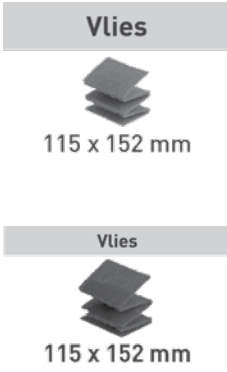
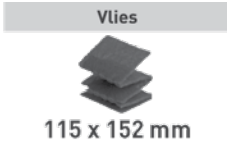
Denomination and application		Order no.	PU	Trade price € excl. VAT per PU ¹⁾	SU	DG		
Granat sanding block manual abrasive, 69 x 98 x 26 mm, "Combiblock" four-sided, rigid abrasive sponge with round and acute-angled side; ideal for sanding areas which are difficult to get to and concave profiles; dimensions: 69 x 98 x 26 mm								
 <p>Granat</p> <p>69 x 98 x 26 mm</p>		Grit	Dimensions mm					
	69x98x26 120 CO GR/6	120	69 x 98 x 26	201084	6	7,20	8	508020
Hand abrasive Granat abrasive sponge 98 x 120 x 13 mm two-sided, flexible abrasive sponge; ideal for sanding radius profiles and mould surfaces; Dimensions: 98 x 120 x 13 mm								
 <p>Granat</p> <p>98 x 120 x 13 mm</p>		Grit	Dimensions mm					
	98x120x13 60 GR/6	60	98 x 120 x 13	201112	6	4,90	8	508020
	98x120x13 120 GR/6	120	98 x 120 x 13	201113	6	4,90	8	508020
	98x120x13 220 GR/6	220	98 x 120 x 13	201114	6	4,90	8	508020
	98x120x13 800 GR/6	800	98 x 120 x 13	201507	6	4,90	8	508020
Hand abrasive Vlies 115 x 152 mm Pre-perforated pads; for roughening and matting old clear coats before applying new coat; Dimensions: 115 x 152 mm								
 <p>Vlies</p> <p>115 x 152 mm</p>		Grit	Dimensions mm					
	115x152 MD 100 VL/25	MEDIUM 100	115 x 152	201115	25	36,90	1	508006
	115x152 FN 320 VL/30	FINE 320	115 x 152	497088	30	36,90	1	508006
 <p>Vlies</p> <p>115 x 152 mm</p>	115x152 SF 800 VL/30	SUPERFINE 800	115 x 152	497089	30	36,90	1	508006





* Attention: Festool products with Bluetooth® technology are not available in all countries.
 For more information, please contact the official local Festool import partner.
 You can find the overview regarding our products and our partners worldwide on our website www.festool.com

PU = Packaging Units
 SU = Shipping Units



¹⁾ Manufacturer's recommended retail price.
 Dealer prices may vary.

Denomination and application		Order no.	PU	Trade price € excl. VAT per PU ¹⁾	SU	DG
Hand abrasive Vlies abrasive roll 115 mm x 10 m for roughening and matting old clear coats before applying new coat; Dimensions: 115 mm x 10 m; in a bag						
			Grit			
 <p>Vlies 115 mm x 10 m</p>	115x10m MD 100 VL Abrasive roll 115x10m FN 320 VL Vlies (201117), Abrasive roll 115x10m SF 800 VL Vlies (201118), Abrasive roll 115x10m UF 1000 VL Vlies (201119) in carton	MEDIUM 100	201116	1	44,60	1 508006
	115x10m FN 320 VL in carton	FINE 320	201117	1	36,70	1 508006
	115x10m SF 800 VL in carton	SUPERFINE 800	201118	1	36,70	1 508006



	Denibber Denibber, LZK-HM with cord; for the accurate removal of trapped particles and unevenness; manufactured from carbide; with hollow grinding dimensions 25 x 30 mm	497525	1	73,50	1	308003
--	---	--------	---	-------	---	--------

Hand sanding block with dust extraction						
   	Sanding block, HSK-A 80x130 compatible abrasive 80 x 133 mm; adapter for Festool hose, bypass adapter Product weight 0,19 kg	496962	1	68,00	1	408004
	Sanding block, HSK-A 115x226 compatible abrasive 115 x 228 mm; adapter for Festool hose, bypass adapter Product weight 0,28 kg	496963	1	128,90	1	408004
	Sanding block, HSK-A 80x400 compatible abrasive 80 x 400 mm; adapter for Festool hose, bypass adapter Product weight 0,52 kg	496964	1	142,30	1	408004
	Sanding block, HSK-A 80x200 compatible abrasive 80 x 400 mm (halved); adapter for Festool hose, bypass adapter Product weight 0,2 kg	496965	1	101,70	1	408004



Abrasives

Denomination and application	Order no.	PU	Trade price		
			€ excl. VAT	SU	DG
 <p>Sanding block, HSK-A-Set compatible abrasive 80 x 133 mm, 115 x 228 mm, 80 x 400 mm; adapter for Festool hose, HSK-A 80x130 [496962], bypass adapter, HSK-A 80x200 [496965], HSK-A 80x400 [496964], HSK-A 115x226 [496963]</p>	497101	1	440,90	1	408004
 <p>Suction hose, D 21,5 x 5m HSK for direct connection (without reducing ring) to hand sanding block with extraction length 5 m; diameter 21,5 mm</p>	495019	1	37,30	1	309001

Hand sanding block without dust extraction

 <p>Sanding block, HSK-D 150 W soft; for attaching StickFix Ø 150 mm sanding discs</p>	495965	1	23,90	1	408004
<p>Sanding block, HSK-D 150 H hard; for attaching StickFix Ø 150 mm sanding discs</p>	495966	1	25,60	1	408004
 <p>Sanding block, HSK 80x133 H hard; for attaching StickFix 80 x 133 mm abrasive sheets</p>	495967	1	25,60	1	408004

Hand-sanding block Pocket StickFix

	Grit	Dimensions mm	Trade price				
			Order no.	PU	€ excl. VAT	SU	DG
 <p>STF 46X178 P40 GR/10</p>	P40	46 x 178	204276	10	7,10	1	508017
<p>STF 46X178 P80 GR/10</p>	P80	46 x 178	204277	10	6,40	1	508017
<p>STF 46X178 P120 GR/10</p>	P120	46 x 178	204278	10	5,50	1	508017
<p>STF 46X178 P180 GR/10</p>	P180	46 x 178	204279	10	5,50	1	508017
 <p>46 x 178 mm</p>  <p>HSK-STF-46x178 for supporting StickFix, abrasive sheets 46 x 178 mm</p>	-	-	583129	1	13,20	1	408004

* Attention: Festool products with Bluetooth® technology are not available in all countries.
For more information, please contact the official local Festool import partner.
You can find the overview regarding our products and our partners worldwide on our website www.festool.com

PU = Packaging Units
SU = Shipping Units

¹⁾ Manufacturer's recommended retail price.
Dealer prices may vary.

Denomination and application

Order no. PU Trade price
€ excl. VAT SU DG
per PU ¹⁾

Geared eccentric sanders

Geared eccentric sander ROTEX RO 90 DX



Geared eccentric sander ROTEX, RO 90 DX FEQ-Plus

FastFix sanding pad, Ø 90 mm (soft-HT) (496804), StickFix sanding pad V93, Festool PROTECTOR (496801), Systainer SYS3 M 187 (204842)

576259 1 535,00 1 108002

Geared eccentric sander ROTEX RO 125



Geared eccentric sander ROTEX, RO 125 FEQ-Plus

FastFix sanding pad Ø 125 mm (soft-HT) (492125), Festool PROTECTOR (493912), Systainer SYS3 M 187 (204842)

576029 1 544,00 1 108002

Geared eccentric sander ROTEX RO 150

MULTI-JETSTREAM 2



Geared eccentric sander ROTEX, RO 150 FEQ

MULTI-JETSTREAM 2 FastFix sanding pad Ø 150 mm (soft W) (202461), Festool PROTECTOR (493913)

575066 1 596,00 1 108002

Geared eccentric sander ROTEX, RO 150 FEQ-Plus

MULTI-JETSTREAM 2 FastFix sanding pad Ø 150 mm (soft W) (202461), Festool PROTECTOR (493913), Systainer SYS3 M 237 (204843)

576017 1 641,00 1 108002

Accessories for geared eccentric sander

Accessories for ROTEX RO 90 FEQ



Protector, FESTOOL 90FX

for RO 90 DX; for protecting the sanding pad and workpiece with minimal edge distance

496801 1 12,10 1 208001



Protector set, FP-RO 90

for RO 90 DX; window protectors S, M, L correspond to approx. 4, 8, 12 mm distance from the edge, depending on frame angle

497936 3 34,10 1 208001

Accessories for ROTEX RO 125 FEQ



Protector, FESTOOL 125FX

for RO 125 FEQ; for protecting the sanding pad and workpiece with minimal edge distance

493912 1 12,10 1 208001

Accessories for ROTEX RO 150 FEQ



Protector, FESTOOL 150FX

for RO 150 FEQ; for protecting the sanding pad and workpiece with minimal edge distance



493913 1 15,00 1 208001

* Attention: Festool products with Bluetooth® technology are not available in all countries.
For more information, please contact the official local Festool import partner.
You can find the overview regarding our products and our partners worldwide on our website www.festool.com





PU = Packaging Units
SU = Shipping Units

¹⁾ Manufacturer's recommended retail price.
Dealer prices may vary.



Polishing

Denomination and application	Order no.	PU	Trade price		
			€ excl. VAT	SU	DG
 <p>Auxiliary handle, ZG-RAS/RO for RO 150, RAS, WTS 150, RAP 150</p>	487865	1	8,90	1	208010
 <p>Handle, BG-RO 150 for RO 150 FEQ</p>	495188	1	23,30	1	208001

Polishing accessories for geared eccentric sander

PoliStick					
 <p>Polishing pad, PT-STF-D90 FX-RO90 for RO 90 DX; FastFix; for holding polishing accessories with dia. 80 mm; Polishing edges; Polishing small surfaces diameter 75 mm</p>	495625	1	35,70	1	408002
 <p>Polishing pad, PT-STF-D125 FX-RO125 for RO 125 FEQ; FastFix; fits polishing accessories diameter 115 mm; height 10 mm</p>	492128	1	25,70	1	408002
 <p>Polishing pad, PT-STF-D150 FX for RO 150 FEQ; FastFix; fits polishing accessories diameter 135 mm; height 10 mm</p>	496151	1	35,40	1	408002
 <p>Polishing pad, PT-STF-D150 M8 for RO 150; fits polishing accessories diameter 135 mm; height 10 mm</p>	496152	1	26,30	1	408002

Rotary polishers

Rotary polisher SHINEX RAP 150					
 <p>Rotary polisher SHINEX, RAP 150-14 FE maximum speed 1400 rpm; additional side-mounted hand grip (487865), StickFix polishing pad Ø 150 mm (488342)</p>	570809	1	528,00	1	108006
 <p>Rotary polisher SHINEX, RAP 150-21 FE maximum speed 2100 rpm; additional side-mounted hand grip (487865), StickFix polishing pad Ø 150 mm (488342)</p>	570811	1	528,00	1	108006
 <p>Rotary polisher SHINEX, RAP 150-21 FE-Set Wood for polishing lacquered surfaces during joining; maximum speed 2100 rpm; additional side-mounted hand grip (487865), StickFix polishing pad Ø 150 mm (488342), denibber (497525), StickFix sanding disc assortment, MPA 5010 OR polish (202048), MPA 9010 BL polish (202050), Polishing sponge PS STF D150x30 OR/5 (201997), Polishing sponge PS STF D150x30 BL/5 (202005), Premium sheepskin LF STF D 150/1 (202046), microfibre polish drapery (205732), finish cleaner (202053), SYS Maxi (490701)</p>	574907	1	702,00	1	108006

* Attention: Festool products with Bluetooth® technology are not available in all countries.
For more information, please contact the official local Festool import partner.
You can find the overview regarding our products and our partners worldwide on our website www.festool.com

PU = Packaging Units
SU = Shipping Units

¹⁾ Manufacturer's recommended retail price.
Dealer prices may vary.

Polishing

Denomination and application

Order no. PU Trade price
€ excl. VAT SU DG
per PU ¹⁾

Accessories for rotary polishers

PoliStick polishing pad



	Diameter mm	Height mm					
PT-STF-D80-M14 for RAP 80; with integrated shock absorber for optimum distribution of pressure during polishing; fits polishing accessories	70	20	488337	1	32,40	1	408002
PT-STF-D150-M14 for RAP 150; with integrated shock absorber for optimum distribution of pressure during polishing; fits polishing accessories	125	25	488342	1	37,30	1	408002
PT-STF-D180-M14 for RAP 180; with integrated shock absorber for optimum distribution of pressure during polishing; fits polishing accessories	165	30	488349	1	41,60	1	408002

PoliStick polishing sponge for dia. 80 mm

for RAP 80, RO 90 DX



	Diameter mm	Height mm					
PS STF D80x20 YE/5 yellow; Coarse; for polishing heavily weathered surfaces (preparation for painting)	80	20	201989	5	26,60	1	508009
PS STF D80x20 OR/5 orange; medium; for preliminary polishing when repairing paint flaws; ideal together with the MPA 5010	80	20	201993	5	29,40	1	508009
PS STF D80x20 BL/5 blue; medium-fine; for removing microscratches in clear coats; ideal together with the MPA 9010	80	20	202001	5	26,90	1	508009
PS STF D80x20 WH/5 white; Fine; for polishing out swirl marks and producing a deep shine; high-gloss polishing; ideal together with the MPA 11010	80	20	202009	5	26,90	1	508009
PS STF D80x20 BA/5 W black; very fine (honeycombed); for removing polish residues on the painted surface	80	20	202017	5	26,60	1	508009

* Attention: Festool products with Bluetooth® technology are not available in all countries.
For more information, please contact the official local Festool import partner.
You can find the overview regarding our products and our partners worldwide on our website www.festool.com

PU = Packaging Units
SU = Shipping Units

¹⁾ Manufacturer's recommended retail price.
Dealer prices may vary.

Polishing

Denomination and application

Order no. PU Trade price
€ excl. VAT SU DG
per PU ¹⁾

Sheepskin and polishing felt for dia. 80 mm

for RAP 80, RO 90 DX



	Diameter mm	Height mm					
LF STF D 80/5 real hair sheepskin for high abrasiveness and an excellent polishing finish; ideal together with the MPA 5010; Suitable for UV paints, scratch-resistant paints; optimum adhesion thanks to full covering with adhesive velour and edge seams	80	18	202044	5	44,00	1	508009
PF-STF-D80x6-H/5 Polishing felt; hard; For preliminary polishing of mineral materials, acrylic glass and gloss paints; white	80	6	488339	5	23,40	1	508009
PF-STF-D80x6-W/5 Polishing felt; soft; for re-polishing mineral materials, acrylic glass and gloss paints; white	80	6	488341	5	23,20	1	508009

PoliStick polishing sponge for dia. 125 mm

for RO 125 FEQ



	Diameter mm	Height mm					
PS STF D125x20 YE/5 yellow; Coarse; for polishing heavily weathered surfaces (preparation for painting)	125	20	201990	5	49,10	1	508009
PS STF D125x20 OR/1 orange; medium; for preliminary polishing when repairing paint flaws; ideal together with the MPA 5010	125	20	202367	1	15,80	1	508009
PS STF D125x20 OR/5 orange; medium; for preliminary polishing when repairing paint flaws; ideal together with the MPA 5010	125	20	201995	5	68,40	1	508009
PS STF D125x20 BL/1 blue; medium-fine; for removing microscratches in clear coats; ideal together with the MPA 9010	125	20	202371	1	14,10	1	508009
PS STF D125x20 BL/5 blue; medium-fine; for removing microscratches in clear coats; ideal together with the MPA 9010	125	20	202003	5	61,10	1	508009
PS STF D125x20 WH/1 white; Fine; for polishing out swirl marks and producing a deep shine; high-gloss polishing; ideal together with the MPA 11010	125	20	202375	1	14,10	1	508009
PS STF D125x20 WH/5 white; Fine; for polishing out swirl marks and producing a deep shine; high-gloss polishing; ideal together with the MPA 11010	125	20	202011	5	61,10	1	508009
PS STF D125x20 BA/1 W black; very fine (honeycombed); for removing polish residues on the painted surface	125	20	202379	1	12,10	1	508009
PS STF D125x20 BA/5 W black; very fine (honeycombed); for removing polish residues on the painted surface	125	20	202018	5	51,20	1	508009

* Attention: Festool products with Bluetooth® technology are not available in all countries.
For more information, please contact the official local Festool import partner.
You can find the overview regarding our products and our partners worldwide on our website www.festool.com

PU = Packaging Units
SU = Shipping Units

¹⁾ Manufacturer's recommended retail price.
Dealer prices may vary.

Sheepskin and polishing felt for dia. 125 mm

for RO 125 FEQ



	Diameter mm	Height mm					
LF STF D 125/1 real hair sheepskin for high abrasiveness and an excellent polishing finish; ideal together with the MPA 5010; Suitable for UV paints, scratch-resistant paints; optimum adhesion thanks to full covering with adhesive velour and edge seams	125	18	202045	1	16,50	1	508009
PF-STF-D125x6-H/5 Polishing felt; hard; For preliminary polishing of mineral materials, acrylic glass and gloss paints; white	125	6	493078	5	30,90	1	508009
PF-STF-D125x6-W/5 Polishing felt; soft; For re-polishing mineral materials, acrylic glass and gloss paints; white	125	6	493077	5	30,70	1	508009

PoliStick polishing sponge for dia. 150 mm

for RO 150, RAP 150



	Diameter mm	Height mm					
PS STF D150x30 YE/5 yellow; Coarse; for polishing heavily weathered surfaces (preparation for painting)	150	30	201991	5	71,80	1	508009
PS STF D150x30 OR/1 orange; medium; for preliminary polishing when repairing paint flaws; ideal together with the MPA 5010	150	30	202369	1	21,00	1	508009
PS STF D150x30 OR/5 orange; medium; for preliminary polishing when repairing paint flaws; ideal together with the MPA 5010	150	30	201997	5	92,30	1	508009
PS STF D150x30 BL/1 blue; medium-fine; for removing microscratches in clear coats; ideal together with the MPA 9010	150	30	202373	1	17,00	1	508009
PS STF D150x30 BL/5 blue; medium-fine; for removing microscratches in clear coats; ideal together with the MPA 9010	150	30	202005	5	72,20	1	508009
PS STF D150x30 WH/1 white; Fine; for polishing out swirl marks and producing a deep shine; high-gloss polishing; ideal together with the MPA 11010	150	30	202377	1	17,00	1	508009
PS STF D150x30 WH/5 white; Fine; for polishing out swirl marks and producing a deep shine; high-gloss polishing; ideal together with the MPA 11010	150	30	202013	5	72,20	1	508009
PS STF D150x30 BA/1 W black; very fine (honeycombed); for removing polish residues on the painted surface	150	30	202380	1	16,50	1	508009
PS STF D150x30 BA/5 W black; very fine (honeycombed); for removing polish residues on the painted surface	150	30	202019	5	71,70	1	508009

* Attention: Festool products with Bluetooth® technology are not available in all countries.
For more information, please contact the official local Festool import partner.
You can find the overview regarding our products and our partners worldwide on our website www.festool.com

PU = Packaging Units
SU = Shipping Units

¹⁾ Manufacturer's recommended retail price.
Dealer prices may vary.

Polishing

Denomination and application

Order no. PU Trade price
€ excl. VAT SU DG
per PU ¹⁾

Sheepskin and polishing felt for dia. 150 mm for RO 150, RAP 150



	Diameter mm	Height mm					
LF STF D 150/1 real hair sheepskin for high abrasiveness and an excellent polishing finish; ideal together with the MPA 5010; Suitable for UV paints, scratch-resistant paints; optimum adhesion thanks to full covering with adhesive velour and edge seams	150	18	202046	1	19,80	1	508009
PF-STF-D150x6-H/1 Polishing felt; hard; For preliminary polishing of mineral materials, acrylic glass and gloss paints; white	150	6	485970	1	9,90	1	508009
PF-STF-D150x6-H/5 Polishing felt; hard; For preliminary polishing of mineral materials, acrylic glass and gloss paints; white	150	6	488348	5	38,80	1	508009
PF-STF-D150x6-W/1 Polishing felt; soft; For re-polishing mineral materials, acrylic glass and gloss paints; white	150	6	485972	1	9,90	1	508009
PF-STF-D150x6-W/5 Polishing felt; soft; For re-polishing mineral materials, acrylic glass and gloss paints; white	150	6	488347	5	38,60	1	508009

PoliStick for Ø 180 mm for RAP 180, POLLUX 180



	Diameter mm	Height mm					
PS STF D180x30 YE/5 yellow; Coarse; for polishing heavily weathered surfaces (preparation for painting)	180	30	201992	5	106,50	1	508009
PS STF D180x30 OR/5 orange; medium; for preliminary polishing when repairing paint flaws; ideal together with the MPA 5010	180	30	201999	5	108,80	1	508009
PS STF D180x30 BL/5 blue; medium-fine; for removing microscratches in clear coats; ideal together with the MPA 9010	180	30	202007	5	103,10	1	508009
PS STF D180x30 WH/5 white; Fine; for polishing out swirl marks and producing a deep shine; high-gloss polishing; ideal together with the MPA 11010	180	30	202015	5	103,10	1	508009
PS STF D180x30 BA/5 W black; very fine (honeycombed); for removing polish residues on the painted surface	180	30	202020	5	101,70	1	508009

* Attention: Festool products with Bluetooth® technology are not available in all countries.
For more information, please contact the official local Festool import partner.
You can find the overview regarding our products and our partners worldwide on our website www.festool.com

PU = Packaging Units
SU = Shipping Units

¹⁾ Manufacturer's recommended retail price.
Dealer prices may vary.

Polishing



Denomination and application			Order no.	PU	Trade price € excl. VAT per PU ¹⁾	SU	DG	
Sheepskin and polishing felt for dia. 180 mm for RAP 180, POLLUX 180								
	LF STF D 180/1 real hair sheepskin for high abrasiveness and an excellent polishing finish; ideal together with the MPA 5010; Suitable for UV paints, scratch-resistant paints; optimum adhesion thanks to full covering with adhesive velour and edge seams	Diameter mm	Height mm					
		180	18	202047	1	28,60	1	508009
	PF-STF-D180x6-H/5 Polishing felt; hard; For preliminary polishing of mineral materials, acrylic glass and gloss paints; white	180	6	488355	5	68,60	1	508009
	PF-STF-D180x6-W/5 Polishing felt; soft; for re-polishing mineral materials, acrylic glass and gloss paints; white	180	6	488354	5	68,60	1	508009
Denibber								
	Denibber, LZK-HM with cord; for the accurate removal of trapped particles and unevenness; manufactured from carbide; with hollow grinding dimensions 25 x 30 mm			497525	1	73,50	1	308003
	Polishing agents							
	Polishing agent, MPA 5010 OR/0,5L Speed Cut 1-step sanding polish; does not contain silicone; water-based; perfect in combination with a sheepskin pad or polishing pad (ORANGE) volume 500 ml			202048	1	33,40	6	508009
	Polishing agent, MPA 9010 BL/0,5L Speed Gloss fine sanding polish; does not contain silicone; water-based; perfect in combination with a polishing pad (BLUE) volume 500 ml			202050	1	27,80	6	508009
	Polishing agent, MPA 11010 WH/0,5L anti-swirl-mark high-gloss polish; does not contain silicone; water-based; perfect in combination with a polishing pad (WHITE) volume 500 ml			202051	1	27,80	6	508009
	Sealing spray, MPA SV+/0,5L for sealing painted surfaces; does not contain silicone; water-based volume 500 ml			202052	1	24,60	6	508009

* Attention: Festool products with Bluetooth® technology are not available in all countries.
For more information, please contact the official local Festool import partner.
You can find the overview regarding our products and our partners worldwide on our website www.festool.com

PU = Packaging Units
SU = Shipping Units

¹⁾ Manufacturer's recommended retail price.
Dealer prices may vary.

Polishing

Denomination and application	Order no.	PU	Trade price € excl. VAT per PU ¹⁾	SU	DG
 <p>Finish-Cleaner, MPA F+/0,5L for removing polish residues and grease marks; does not contain silicone; water-based volume 500 ml</p>	202053	1	19,50	6	508009
 <p>Microfibre cloth, MPA-Microfibre/2 for excellent finish of new paints; for removing polish residues and grease marks</p>	205732	2	25,20	1	508009

* Attention: Festool products with Bluetooth® technology are not available in all countries.
For more information, please contact the official local Festool import partner.
You can find the overview regarding our products and our partners worldwide on our website www.festool.com

PU = Packaging Units
SU = Shipping Units

¹⁾ Manufacturer's recommended retail price.
Dealer prices may vary.

Denomination and application

Order no. PU Trade price
€ excl. VAT SU DG
per PU ¹⁾

CTL SYS mobile dust extractor



CTL SYS mobile dust extractor

Mobile dust extractor CLEANTEC, CTL SYS

container/filter bag capacity 4.5/3.5 l; approval for dust class L; only suitable for dry extraction; fitted filter bag, smooth suction hose dia. 27 x 3 m AS/CT with rotating angle adapter on the extractor side (201665), hose holder, SYS-Dock with T-LOC function, upholstery nozzle D 36 PD (500592), crevice nozzle D 36 FD-150 (500593), SYS-CT carrying belt (500532)

575279 1 360,00 1 109003

Mobile dust extractors CT

CLEANTEC CT 15 mobile dust extractor

Mobile dust extractor CLEANTEC, CT 15 E

container/filter bag capacity 15 l; High-performance main filter (204200), suction hose diameter 27/32 x 3.5 m (205201), SC FIS-CT SELFCLEAN filter bag, crevice nozzle D 36 FD-150 (500593), upholstery nozzle D 36 PD (500592)

574827 1 321,00 1 109003

Mobile dust extractor CLEANTEC, CT 15 E-Set

container/filter bag capacity 15 l; High-performance main filter (204200), suction hose diameter 27/32 x 3.5 m (205201), SC FIS-CT SELFCLEAN filter bag, crevice nozzle D 36 FD-150 (500593), upholstery nozzle D 36 PD (500592), curved hand tube D 36 HR-K AS (203129), extension pipes D 36 VR-K AS (203137), 4-piece floor nozzle D 36 BD270 (452906)

575988 1 357,00 1 109003



Mobile dust extractors CTL

Mobile dust extractor CLEANTEC CTL MINI

Mobile dust extractor CLEANTEC, CTL MINI

approval for dust class L; container/filter bag capacity 10/7,5 l; with manual filter and filter bag cleaning; smooth suction hose dia. 27/32 x 3.5 m AS/CTR (204921), SC FIS-CT SELFCLEAN filter bag, hose holder, cable holder, SYS-Dock with T-LOC function

575442 1 454,00 1 109003



Mobile dust extractor CLEANTEC CTL MIDI

Mobile dust extractor CLEANTEC, CTL MIDI

approval for dust class L; container/filter bag capacity 15/12.5 l; with manual filter and filter bag cleaning; smooth suction hose dia. 27/32 x 3.5 m AS/CTR (204921), SC FIS-CT SELFCLEAN filter bag, hose holder, cable holder, SYS-Dock with T-LOC function

575443 1 496,00 1 109003



Mobile dust extractor CLEANTEC CTL 26







Mobile dust extractor CLEANTEC, CTL 26 E

container/filter bag capacity 26/24 l; approval for dust class L; High-performance main filter (496170), SELFCLEAN filter bag, smooth suction hose dia. 27/32 x 3.5 m AS/CTR (204921), hose holder, SYS-Dock with T-LOC function, cable holder

574947 1 627,00 1 109004



Dust extraction







Denomination and application		Order no.	PU	Trade price € excl. VAT per PU ¹⁾	SU	DG
	Mobile dust extractor CLEANTEC, CTL 26 E SD container/filter bag capacity 26/24 l; approval for dust class L; High-performance main filter (496170), SELFCLEAN filter bag, smooth suction hose dia. 27/32 x 3.5 m AS/CTR (204921), hose holder, SYS-Dock with T-LOC function, second socket with continuous current, cable holder	574955	1	672,00	1	109004
	Mobile dust extractor CLEANTEC, CTL 26 E SD E/A container/filter bag capacity 26/24 l; approval for dust class L; High-performance main filter (496170), SELFCLEAN filter bag, smooth suction hose dia. 27/32 x 3.5 m AS/CTR (204921), hose holder, SYS-Dock with T-LOC function, second socket with automatic electronic switch-on/shut-off, cable holder	574956	1	672,00	1	109004
Mobile dust extractor CLEANTEC CTL 26 AC with automatic main filter cleaning						
	Mobile dust extractor CLEANTEC, CTL 26 E AC container/filter bag capacity 26/24 l; with AUTOCLEAN function; approval for dust class L; High-performance main filter (203759), SELFCLEAN filter bag, disposal bag, smooth suction hose dia. 27/32 x 3.5 m AS/CTR (204921), hose holder, SYS-Dock with T-LOC function, cable holder	574945	1	735,00	1	109004
	Mobile dust extractor CLEANTEC, CTL 26 E AC RENOFIX container/filter bag capacity 26/24 l; with AUTOCLEAN function; approval for dust class L; special extractor for RENOFIX surface-restoration millers and diamond grinders; High-performance main filter (203759), disposal bag, smooth suction hose dia. 36/32 x 3.5 m AS/R with rotating connecting sleeves (204923), Comfort clean closing slide (497926), hose holder, cable holder	575841	1	752,00	1	109004
Mobile dust extractor CLEANTEC CTL 36						
	Mobile dust extractor CLEANTEC, CTL 36 E container/filter bag capacity 36/34 l; approval for dust class L; High-performance main filter (496170), SELFCLEAN filter bag, smooth suction hose dia. 27/32 x 3.5 m AS/CTR (204921), hose holder, SYS-Dock with T-LOC function, cable holder	574965	1	757,00	1	109004
	Mobile dust extractor CLEANTEC, CTL 36 E LE container/filter bag capacity 36/34 l; approval for dust class L; with LE compressed air supply; High-performance main filter (496170), SELFCLEAN filter bag, compressed air module (496141), smooth suction hose dia. 27/32 x 3.5 m AS/CTR (204921), hose holder, SYS-Dock with T-LOC function, cable holder	574972	1	957,00	1	109004
Mobile dust extractor CLEANTEC CTL 36 AC with automatic main filter cleaning						
	Mobile dust extractor CLEANTEC, CTL 36 E AC container/filter bag capacity 36/34 l; with AUTOCLEAN function; approval for dust class L; High-performance main filter (203759), SELFCLEAN filter bag, disposal bag, smooth suction hose dia. 27/32 x 3.5 m AS/CTR (204921), hose holder, SYS-Dock with T-LOC function, cable holder	574958	1	864,00	1	109004

* Attention: Festool products with Bluetooth® technology are not available in all countries.
 For more information, please contact the official local Festool import partner.
 You can find the overview regarding our products and our partners worldwide on our website www.festool.com

PU = Packaging Units
 SU = Shipping Units

¹⁾ Manufacturer's recommended retail price.
 Dealer prices may vary.

Dust extraction







Denomination and application		Order no.	PU	Trade price € excl. VAT per PU ¹⁾	SU	DG
	Mobile dust extractor CLEANTEC, CTL 36 E AC-LHS container/filter bag capacity 36/34 l; with AUTOCLEAN function; approval for dust class L; High-performance main filter (203759), kink-resistant suction hose D36x3.5-AS/LHS 225 (496972), SELFCLEAN filter bag, disposal bag, Comfort clean closing slide (497926), hose holder, cable holder	574960	1	882,00	1	109004
	Mobile dust extractor CLEANTEC, CTL 36 E AC RENOFIX container/filter bag capacity 36/34 l; with AUTOCLEAN function; approval for dust class L; special extractor for RENOFIX surface-restoration millers and diamond grinders; High-performance main filter (203759), disposal bag, smooth suction hose dia. 36/32 x 3.5 m AS/R with rotating connecting sleeves (204923), Comfort clean closing slide (497926), hose holder, cable holder	575842	1	882,00	1	109004
	Mobile dust extractor CLEANTEC, CTL 36 E AC-PLANEX container/filter bag capacity 36/34 l; with AUTOCLEAN function; approval for dust class L; special extractor for all PLANEX long-reach sanders; High-performance main filter (203759), SELFCLEAN filter bag, disposal bag, kink-resistant suction hose D36x3.5-AS/LHS 225 (496972), Comfort clean closing slide (497926), hose holder, PLANEX tool holder (205274), cable holder	576850	1	916,00	1	109004
Mobile dust extractor CLEANTEC CTL 48						
	Mobile dust extractor CLEANTEC, CTL 48 E container/filter bag capacity 48/46 l; approval for dust class L; High-performance main filter (496170), SELFCLEAN filter bag, smooth suction hose dia. 27/32 x 3.5 m AS/CTR (204921), hose holder, SYS-Dock with T-LOC function, cable holder, handle (497295)	574975	1	865,00	1	109004
Mobile dust extractor CLEANTEC CTL 48 AC with automatic main filter cleaning						
	Mobile dust extractor CLEANTEC, CTL 48 E AC container/filter bag capacity 48/46 l; with AUTOCLEAN function; approval for dust class L; High-performance main filter (203759), SELFCLEAN filter bag, disposal bag, smooth suction hose dia. 27/32 x 3.5 m AS/CTR (204921), hose holder, SYS-Dock with T-LOC function, cable holder, handle (497295)	574974	1	968,00	1	109004
Mobile dust extractors CTM						
Mobile dust extractor CLEANTEC CTM 26						
	Mobile dust extractor CLEANTEC, CTM 26 E container/filter bag capacity 26/24 l; approved for dust class M; High-performance main filter (496170), SELFCLEAN filter bag, smooth suction hose dia. 27/32 x 3.5 m AS/CTR (204921), end cap for intake adapter, hose holder, SYS-Dock with T-LOC function, cable holder	574981	1	835,00	1	109005
Mobile dust extractor CLEANTEC CTM 26 AC with automatic main filter cleaning						
	Mobile dust extractor CLEANTEC, CTM 26 E AC container/filter bag capacity 26/24 l; with AUTOCLEAN function; approved for dust class M; High-performance main filter (203759), SELFCLEAN filter bag, disposal bag, smooth suction hose dia. 27/32 x 3.5 m AS/CTR (204921), end cap for intake adapter, hose holder, SYS-Dock with T-LOC function, cable holder	574978	1	938,00	1	109005

* Attention: Festool products with Bluetooth® technology are not available in all countries.
For more information, please contact the official local Festool import partner.
You can find the overview regarding our products and our partners worldwide on our website www.festool.com

PU = Packaging Units
SU = Shipping Units

¹⁾ Manufacturer's recommended retail price.
Dealer prices may vary.

Dust extraction

Denomination and application		Order no.	PU	Trade price € excl. VAT per PU ¹⁾	SU	DG
Mobile dust extractor CLEANTEC CTM 36						
	Mobile dust extractor CLEANTEC, CTM 36 E container/filter bag capacity 36/34 l; approved for dust class M; High-performance main filter (496170), SELFCLEAN filter bag, smooth suction hose dia. 27/32 x 3.5 m AS/CTR (204921), end cap for intake adapter, hose holder, SYS-Dock with T-LOC function, cable holder	574988	1	957,00	1	109005
	Mobile dust extractor CLEANTEC, CTM 36 E LE container/filter bag capacity 36/34 l; approved for dust class M; with LE compressed air supply; High-performance main filter (496170), SELFCLEAN filter bag, smooth suction hose dia. 27/32 x 3.5 m AS/CTR (204921), end cap for intake adapter, hose holder, SYS-Dock with T-LOC function, cable holder, compressed air module (496141)	574990	1	1.155,00	1	109005
Mobile dust extractor CLEANTEC CTM 36 AC with automatic main filter cleaning						
	Mobile dust extractor CLEANTEC, CTM 36 E AC container/filter bag capacity 36/34 l; with AUTOCLEAN function; approved for dust class M; High-performance main filter (203759), SELFCLEAN filter bag, disposal bag, smooth suction hose dia. 27/32 x 3.5 m AS/CTR (204921), end cap for intake adapter, hose holder, SYS-Dock with T-LOC function, cable holder	574983	1	1.060,00	1	109005
	Mobile dust extractor CLEANTEC, CTM 36 E AC-LHS container/filter bag capacity 36/34 l; with AUTOCLEAN function; approved for dust class M; High-performance main filter (203759), SELFCLEAN filter bag, disposal bag, kink-resistant suction hose D36x3.5-AS/LHS 225 (496972), Comfort clean closing slide (497926), hose holder, SYS-Dock with T-LOC function, cable holder	574984	1	1.073,00	1	109005
	Mobile dust extractor CLEANTEC, CTM 36 E AC RENOFIX container/filter bag capacity 36/34 l; with AUTOCLEAN function; approved for dust class M; special extractor for RENOFIX surface-restoration millers and diamond grinders; High-performance main filter (203759), disposal bag, smooth suction hose dia. 36/32 x 3.5 m AS/R with rotating connecting sleeves (204923), Comfort clean closing slide (497926), hose holder, cable holder	575846	1	1.073,00	1	109005
	Mobile dust extractor CLEANTEC, CTM 36 E AC-PLANEX container/filter bag capacity 36/34 l; with AUTOCLEAN function; approved for dust class M; special extractor for all PLANEX long-reach sanders; for mineral dust; High-performance main filter (203759), SELFCLEAN filter bag, disposal bag, kink-resistant suction hose D36x3.5-AS/LHS 225 (496972), Comfort clean closing slide (497926), hose holder, PLANEX tool holder (205274), SYS-Dock with T-LOC function, cable holder	576853	1	1.108,00	1	109005
Mobile dust extractor CLEANTEC CTM 48						
	Mobile dust extractor CLEANTEC, CTM 48 E container/filter bag capacity 48/46 l; approved for dust class M; High-performance main filter (496170), SELFCLEAN filter bag, smooth suction hose dia. 27/32 x 3.5 m AS/CTR (204921), end cap for intake adapter, hose holder, SYS-Dock with T-LOC function, cable holder, handle (497295)	574992	1	1.058,00	1	109005

* Attention: Festool products with Bluetooth® technology are not available in all countries.
For more information, please contact the official local Festool import partner.
You can find the overview regarding our products and our partners worldwide on our website www.festool.com



PU = Packaging Units
SU = Shipping Units

¹⁾ Manufacturer's recommended retail price.
Dealer prices may vary.

Dust extraction

Denomination and application	Order no.	PU	Trade price		
			€ excl. VAT	SU	DG
Mobile dust extractor CLEANTEC CTM 48 AC with automatic main filter cleaning					
					
Mobile dust extractor CLEANTEC, CTM 48 E AC container/filter bag capacity 48/46 l; with AUTOCLEAN function; approved for dust class M; High-performance main filter (203759), hose holder, SELFCLEAN filter bag, disposal bag, smooth suction hose dia. 27/32 x 3.5 m AS/CTR (204921), end cap for intake adapter, SYS-Dock with T-LOC function, handle (497295), cable holder	574991	1	1.161,00	1	109005

Special extractors

Mobile dust extractor CLEANTEC CT 48 EC B22 with EC-TEC motor; for flammable and explosive dust from St1, St2 and St3 explosion classes in zone 22					
					
Mobile dust extractor CLEANTEC, CTL 48 E LE EC/B22 R1 container/filter bag capacity 48/46 l; approval for dust class L; compressed air connection with additional air flow -I/O- Automatic; EAA connection; High-performance main filter (496170), SELFCLEAN filter bag, smooth suction hose dia. 27/32 x 3.5 m AS/CTR (204921), cable holder, compressed air module (496141)	575275	1	2.281,00	1	109008
					
Mobile dust extractor CLEANTEC, CTM 48 E LE EC B22 R1 container/filter bag capacity 48/46 l; approved for dust class M; compressed air connection with additional air flow -I/O- Automatic; EAA connection; SELFCLEAN filter bag, smooth suction hose dia. 27/32 x 3.5 m AS/CTR (204921), cable holder, compressed air module (496141)	575286	1	2.474,00	1	109008



Special application mobile dust extractor CLEANTEC CTH 26					
					
Mobile dust extractor CLEANTEC, CTH 26 E / a container/filter bag capacity 26/24 l; approval for dust class H, for carcinogenic dust; High-performance main filter (498995), safety filter bag, smooth suction hose dia. 27/32 x 3.5 m AS/CTR (204921), hose holder, SYS-Dock with T-LOC function, cable holder	574939	1	964,00	1	109008

Special application mobile dust extractor CLEANTEC CTH 48					
					
Mobile dust extractor CLEANTEC, CTH 48 E / a container/filter bag capacity 48/46 l; approval for dust class H, for carcinogenic dust; High-performance main filter (498995), safety filter bag, smooth suction hose dia. 27/32 x 3.5 m AS/CTR (204921), hose holder, SYS-Dock with T-LOC function, cable holder, handle (497295)	574941	1	1.189,00	1	109008



Pre-separator

CT-VA pre-separator					
					
CT pre-separator, CT-VA-20 for CT 26/36/48; for combining with all Festool CT 26/36/48 dust extractors with and without AUTOCLEAN function; approved for dust categories L and M; optimum use with machines and applications with high levels of dust; prevents suction support on the LHS 225 EQ; cyclone Systainer, VAB-20 collection container (204294), Systainer pan, connecting hose, disposal bag, container lid	204083	1	383,10	1	209002

Dust extraction

Denomination and application	Order no.	PU	Trade price € excl. VAT per PU ¹⁾	SU	DG
Accessories for CT-VA pre-separator					
 <p>Collection container, VAB-20/1 for CT-VA 20 pre-separator; can be stacked, with compact dimensions, easy to handle and robust design; can be well sealed for transportation using the cover (included in scope of delivery) dimensions (L x W x H) 395 x 295 x 350 mm; max. container capacity 20 l</p>	204294	1	76,70	1	209002
 <p>Disposable bag, ENS-VA-20/10 ideal shape for CT-VA 20 pre-separator collection container; for class L and M dust; for use in VAB-20 collection container; includes 10 cable ties max. container capacity 20 l</p>	204296	10	24,80	1	409001
 <p>Connecting cable, CT-VA AK for CT-VA 20 pre-separator; for retrofitting the CT-VA pre-separator with additional electrical outlet module; enables particularly easy connection of the plug it suction hose with the CT-VA pre-separator max. appliance socket connected load 2400 W; cable length 0,85 m</p>	575667	1	38,40	1	209002

Mobile boom arm

CT boom arm					
 <p>Boom arm, CT-ASA CT 26/36/SB for CT 26/36; with the SB-CT 26/36 handle; boom arm for mounting to all CT 26/36 models (except CT 26/36 AC HD); pipe set with connections, handle length 2119 mm; width 1136 mm</p>	496372	1	450,90	1	209003
 <p>Boom arm, CT-ASA for CT 44, CT 48; without handle; pipe set with connections length 2119 mm; width 1136 mm</p>	492452	1	311,30	1	209003

Accessories for CT boom arm

 <p>Tool holder, WHR/CT-ASA for CT-ASA, CT-ASA/SB; for safe, ergonomic storage of two electric power or pneumatic tools</p>	493558	1	63,90	1	215001
---	--------	---	-------	---	--------







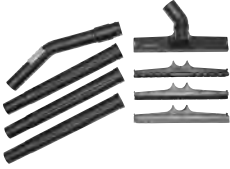

Accessories for mobile dust extractors CT and dust extractors SR

Cleaning sets					
 <p>Cleaning set, D 27 / D 36 D-RS for simple cleaning tasks and to supplement existing cleaning sets; crevice nozzle D 36 FD-210 [492391], upholstery nozzle D 36 PD [500592], suction brush D 36 SP [440404]</p>	492392	1	15,70	1	309002

* Attention: Festool products with Bluetooth® technology are not available in all countries.
For more information, please contact the official local Festool import partner.
You can find the overview regarding our products and our partners worldwide on our website www.festool.com

PU = Packaging Units
SU = Shipping Units

¹⁾ Manufacturer's recommended retail price.
Dealer prices may vary.

Denomination and application	Order no.	PU	Trade price		
			€ excl. VAT per PU ¹⁾	SU	DG
 <p>Standard cleaning set, D 27/D 36 S-RS curved hand tube D 36 HR-K AS (203129), extension pipes D 36 VR-K AS (203137), 4-piece floor nozzle D 36 BD270 (452906), upholstery nozzle D 36 PD (500592), crevice nozzle D 36 FD-210 (492391)</p>	203428	1	45,40	1	309002
 <p>Standard cleaning set, D 27/D 36 B-RS curved hand tube D 36 HR-K AS (203129), extension pipes D 36 VR-K AS (203137), 4-piece floor nozzle D 36 BD270 (452906)</p>	205109	1	36,60	1	309002
 <p>Professional cleaning set, D 27/36 P-RS curved hand tube D 36 HR-K AS (203129), extension tube, special steel 3-piece D 36 VR-M3x (452902), D 36 TD II carpet nozzle (203797), crevice nozzle D 36 FD-210 (492391)</p>	203429	1	91,40	1	309002
 <p>Compact cleaning set, D 27/36 K-RS-Plus curved hand tube D 36 HR-K AS (203129), extension pipes D 36 VR-K AS (203137), 4-piece floor nozzle D 36 BD270 (452906), crevice nozzle, D 36 FD-300 (452904), upholstery nozzle D 36 PD (500592), Systainer SYS3 M 112 (204840)</p>	576839	1	81,70	1	309002
 <p>Construction cleaning set, D 36 BA-RS for all CT and VCP (except VCP 30 E); construction set; suction hose D 36 x 3 m, curved hand tube D 36 HR-K AS (203129), stainless steel extension tubes, 2-piece, 4-piece floor nozzle D 36 BD270 (452906), crevice nozzle D 36 FD-210 (492391), suction brush D 36 SP (440404)</p>	203433	1	134,70	1	309002
 <p>Cleaning set, D 36 BU-RS for all CT and VCP (except VCP 30 E); office set; suction hose D 36 x 3 m, curved hand tube D 36 HR-K AS (203129), stainless steel extension tubes, 2-piece, D 36 TD II carpet nozzle (203797), upholstery nozzle D 36 PD (500592), crevice nozzle D 36 FD-210 (492391)</p>	203434	1	134,70	1	309002
 <p>Masonry renovation cleaning set, D 36 M-RS-Plus curved hand tube D 36 HR-K AS (203129), extension tube, special steel 3-piece D 36 VR-M3x (452902), D 36 TD II carpet nozzle (203797), crevice nozzle D 36 FD-210 (492391), upholstery nozzle D 36 PD (500592), Systainer SYS3 M 187 (204842)</p>	576840	1	151,10	1	309002
 <p>Floor cleaning set, D 36 BD 370 RS-Plus curved hand tube D 36 HR-K AS (203129), extension tube, special steel 3-piece D 36 VR-M3x (452902), floor nozzle, D 36 BD 370 (452908), Systainer SYS3 M 187 (204842)</p>	576841	1	225,90	1	309002
 <p>Cleaning set for tradesmen, D 36 HW-RS-Plus smooth suction hose D 36 x 3.5 m, antistatic (204924), curved hand tube D 36 HR-K AS (203129), extension tube, special steel 3-piece D 36 VR-M3x (452902), D 36 TD II carpet nozzle (203797), crevice nozzle D 36 FD-210 (492391), upholstery nozzle D 36 PD (500592), suction brush D 36 SP (440404), Systainer SYS3 M 437 (204845)</p>	576837	1	257,60	1	309002
 <p>Cleaning set for the workshop, D 36 WB-RS-Plus smooth suction hose D 36 x 3.5 m, antistatic (204924), curved hand tube D 36 HR-K AS (203129), extension tube, special steel 3-piece D 36 VR-M3x (452902), floor nozzle, D 36 BD 370 (452908), Systainer SYS3 M 437 (204845)</p>	576838	1	274,60	1	309002

* Attention: Festool products with Bluetooth® technology are not available in all countries.
For more information, please contact the official local Festool import partner.
You can find the overview regarding our products and our partners worldwide on our website www.festool.com

PU = Packaging Units
SU = Shipping Units

¹⁾ Manufacturer's recommended retail price.
Dealer prices may vary.

Dust extraction

Denomination and application		Order no.	PU	Trade price € excl. VAT per PU ¹⁾	SU	DG
	Universal cleaning set, D 36 UNI-RS-Plus suction hose D 36 x 3.5 m (452881), curved hand tube D 36 HR-K AS (203129), extension pipes D 36 VR-K AS (203137), floor nozzle, D 36 BD 300 (452907), crevice nozzle D 36 FD-210 (492391), suction brush D 36 SP (440404), upholstery nozzle D 36 PD (500592), Systainer SYS3 M 437 (204845)	576842	1	161,70	1	309002
	Cleaning set for industrial use, D 50 GS-RS suction hose Ø 50 x 2,5m, extension tubes D50VR-K (440412), floor nozzle D 50 BD370, square nozzle D 50 QD, suction brush D 50 SP (440419), crevice nozzle D 50 FD (452912)	454770	1	123,10	1	309002
Tubes						
	Hand tube, D 36 HR-K AS for D 27/D 36; antistatic; with sliding air regulator for suction power adjustment; with bayonet fitting for secure connection to the extractor hose; curved diameter 36 mm	203129	1	25,50	1	309001
	Extension pipe, D 36 VR-M 3x for D 27/D 36; of stainless steel, 3-piece length 950 mm	452902	3	62,30	1	309001
	Extension pipe, D 36 VR-K AS 3x for D 27/D 36; antistatic; 3-piece length 950 mm	203137	3	28,60	1	309001
	Extension pipe, D 50 VR-M for D 50; anodised aluminium, 1 piece length 1100 mm; in carton	447599	1	122,40	1	309001
	Extension pipe, D 50 VR-K 2x for D 50; plastic, 2 pieces length 970 mm	440412	2	38,80	1	309001
Floor nozzles						
	Floor nozzle, D 36 BD 370 for D 27/D 36; high-quality industrial design, aluminium, with 2 castors and 2 brush inserts width 370 mm; diameter 36 mm	452908	1	151,60	1	309001
	Floor nozzle, D 50 BD 450 for D 50; high-quality industrial design, aluminium, with 2 castors and 2 brush inserts width 450 mm	452910	1	170,50	1	309001
	Floor nozzle, D 36 BD 300 for D 27/D 36; plastic, with 2 castors and 2 brush inserts width 300 mm; diameter 36 mm	452907	1	38,90	1	309001

* Attention: Festool products with Bluetooth® technology are not available in all countries.
For more information, please contact the official local Festool import partner.
You can find the overview regarding our products and our partners worldwide on our website www.festool.com

PU = Packaging Units
SU = Shipping Units

¹⁾ Manufacturer's recommended retail price.
Dealer prices may vary.

Dust extraction



Denomination and application		Order no.	PU	Trade price € excl. VAT per PU ¹⁾	SU	DG
	Floor nozzle, D 36 BD 270 for D 27/D 36; 4 pieces, plastic, with 3 replaceable inserts (brushes, rubber lips, carpet) width 270 mm; diameter 36 mm	452906	1	35,50	1	309001
	Carpet nozzle, D 36 TD II for D 27/D 36; with sliding base, changeover from carpet to smooth floor width 292 mm	203797	1	53,60	1	309001
	Turbo combination suction brush, D 36 TKB II for D 27/D 36; for textile and linoleum floors, with 4 castors, brush rollers driven by intake air width 270 mm	203809	1	137,30	1	309001
Special nozzles/brushes						
	Crevice nozzle, D 36 FD-150 for D 27/D 36; for CTL SYS; plastic; suitable for the accessory storage of the CTL SYS and CT 15 length 150 mm; diameter 36 mm	500593	1	7,10	1	309001
	Crevice nozzle, D 36 FD-210 for D 27/D 36; plastic length 210 mm; diameter 36 mm	492391	1	7,10	1	309001
	Crevice nozzle, D 36 FD-300 for D 27/D 36; plastic length 300 mm; diameter 36 mm	452904	1	8,60	1	309001
	Crevice nozzle, D 50 FD for D 50; plastic length 200 mm	452912	1	22,60	1	309001
	Suction brush, D 36 SP for D 27/D 36; Plastic diameter 70 mm	440404	1	12,00	1	309001
	Suction brush, D 50 SP for D 50; Plastic diameter 85 mm	440419	1	32,00	1	309001

* Attention: Festool products with Bluetooth® technology are not available in all countries.
For more information, please contact the official local Festool import partner.
You can find the overview regarding our products and our partners worldwide on our website www.festool.com

PU = Packaging Units
SU = Shipping Units

¹⁾ Manufacturer's recommended retail price.
Dealer prices may vary.

Dust extraction

Denomination and application	Order no.	PU	Trade price		
			€ excl. VAT	SU	DG
			per PU ¹⁾		
 <p>Upholstery nozzle, D 36 PD for D 27/D 36; for CTL SYS; plastic, with brush insert; fits in the accessory storage of the CTL SYS width 120 mm</p>	500592	1	9,30	1	309001
 <p>Universal brush nozzle, D 36 UBD for D 27/D 36; plastic; with brush rim and rotary hinge</p>	498527	1	17,10	1	309001
 <p>Flat nozzle, D 27 FDG for D 27; special rubber, oil resistant width 100 mm; diameter 27 mm</p>	440408	1	60,00	1	309001

Smooth suction hose, antistatic version

	Diameter mm	Length m	Bleeder resistor (DIN IEC 312) MΩ/m					
 <p>D27/32x3,5m-AS/CTR for CT 26/36/48; for CT MINI and CT MIDI from YOM 2019 onwards; antistatic; temperature-resistant to +70 °C; with rotating adapter and connector; smooth; Conical</p>	27 / 32	3,5	<1	204921	1	155,50	1	309001
 <p>D27/32x5m-AS/CTR for CT 26/36/48; for CT MINI and CT MIDI from YOM 2019 onwards; antistatic; temperature-resistant to +70 °C; with rotating adapter and connector; smooth; Conical</p>	27 / 32	5	<1	204922	1	189,80	1	309001
 <p>D 27x3,0m-AS-90°/CT for CTL SYS; antistatic; temperature-resistant to +70 °C; with rotating angle adapter at extractor side; smooth</p>	27	3	<1	201665	1	123,00	1	309001
 <p>D 27/32x3,5m-AS-90°/CT for CTL MINI/MIDI manufactured until 12/2018; antistatic; temperature-resistant to +70 °C; with rotating angle adapter at extractor side; smooth; Conical</p>	27 / 32	3,5	<1	500680	1	155,50	1	309001
 <p>D36/32x3,5m-AS/R suitable for dust extractors with AUTOCLEAN; antistatic; temperature-resistant to +70 °C; for masonry renovation and cleaning work; smooth; Conical</p>	36 / 32	3,5	<1	204923	1	165,40	1	309001
 <p>D36x3,5m-AS/CTR for cleaning tasks with CT dust extractors; not suitable for dust extractors with AUTOCLEAN; antistatic; temperature-resistant to +70 °C; with rotating adapter and connector; smooth</p>	36	3,5	<1	204924	1	176,80	1	309001

* Attention: Festool products with Bluetooth® technology are not available in all countries.
For more information, please contact the official local Festool import partner.
You can find the overview regarding our products and our partners worldwide on our website www.festool.com

PU = Packaging Units
SU = Shipping Units

¹⁾ Manufacturer's recommended retail price.
Dealer prices may vary.

Dust extraction

Denomination and application

Order no. PU Trade price
€ excl. VAT SU DG
per PU ¹⁾



	Diameter mm	Length m	Bleeder resistor (DIN IEC 312) MΩ/m					
D36x5m-AS/CTR for cleaning tasks with CT dust extractors; not suitable for dust extractors with AUTOCLEAN; antistatic; temperature-resistant to +70 °C; with rotating adapter and connector; smooth	36	5	<1	204925	1	227,40	1	309001
D36x7m-AS/CTR for cleaning tasks with CT dust extractors; not suitable for dust extractors with AUTOCLEAN; antistatic; temperature-resistant to +70 °C; with rotating adapter and connector; smooth	36	7	<1	204926	1	288,70	1	309001

Suction hose antistatic version



	Diameter mm	Length m	Bleeder resistor (DIN IEC 312) MΩ/m					
D 27 MW-AS antistatic; temperature-resistant to +70 °C; ordered by metre (without rotating adapter or reducing sleeve)	27	–	<1	452384	1	36,40	1	309001
D 36x3,5-AS/KS/LHS 225 for long-reach sander PLANEX; antistatic; temperature-resistant to +70 °C; extremely flexible; kink-resistant suction hose	36	3,5	<1	496972	1	170,80	1	309001
D 36x3,5-AS/KS/B/LHS 225 for long-reach sander PLANEX; antistatic; temperature-resistant to +70 °C; extremely flexible; kink-resistant suction hose; with bypass sleeve for extremely light fillers: enables the suction effect of the PLANEX on the wall to be reduced to an absolute minimum	36	3,5	<1	577101	1	171,70	1	309001
D 36 MW-AS antistatic; temperature-resistant to +70 °C; ordered by metre (without rotating adapter or reducing sleeve)	36	–	<1	452385	1	45,60	1	309001
D 50x2,5m-AS antistatic; temperature-resistant to +70 °C; with 2x rotating adapter	50	2,5	<1	452888	1	141,30	1	309001
D 50x4m-AS antistatic; temperature-resistant to +70 °C; with 2x rotating adapter	50	4	<1	452890	1	213,70	1	309001
D 50 MW-AS antistatic; ordered by metre (without rotating adapter or reducing sleeve); temperature-resistant to +70 °C	50	–	<1	452386	1	50,20	1	309001

Suction hose





	Diameter mm	Length m					
D 27 MW ordered by metre (without rotating adapter or reducing sleeve); temperature-resistant to +70 °C	27	–	452383	1	23,20	1	309001
D 27/32x3,5m for CT 15; temperature-resistant to +70 °C; with rotating adapter and connector	27/32	3,5	205201	1	78,30	1	309001

* Attention: Festool products with Bluetooth® technology are not available in all countries.
For more information, please contact the official local Festool import partner.
You can find the overview regarding our products and our partners worldwide on our website www.festool.com



PU = Packaging Units
SU = Shipping Units

¹⁾ Manufacturer's recommended retail price.
Dealer prices may vary.

Dust extraction

Denomination and application	Diameter mm	Length m	Order no.	PU	Trade price			DG
					€ excl. VAT	SU	per PU ¹⁾	
 <p>D 36x3,5m/CT temperature-resistant to +70 °C; with rotating adapter and connector</p>	36	3,5	452881	1	98,20	1	309001	
 <p>D 36 MW ordered by metre (without rotating adapter or reducing sleeve); temperature-resistant to +70 °C</p>	36	-	454157	1	28,80	1	309001	
 <p>AD-D 36/CS50/CS70/CMS for CS 50, CS 70, CMS; 0.5 m hose D36 with two rotating adapters and connection coupling, anti-static D50/D50 VM-AS; for Y-shaped connection (452898) in conjunction with CTL MINI/MIDI and CTM MIDI</p>	36	0,5	499196	1	37,60	1	309001	

CLEANTEC suction hose plug it D 27 and D 32

	Diameter mm	Length m	Bleeder resistor (DIN IEC 312) MΩ/m	Trade price				
				Order no.	PU	€ excl. VAT	SU	DG
 <p>D 27/22x3,5m-AS-GQ/CT for all power tools with D27 and D36 flange (all Festool power tools) and cleaning accessories; with plug it-connection; antistatic; suitable for sanding applications; with rotating adapter and reducing sleeve with bayonet fitting; temperature-resistant to +70 °C; smooth</p>	27 /22	3,5	<1	200041	1	192,90	1	209004
<p>D 27/22x5m-AS-GQ/CT for all power tools with D27 and D36 flange (all Festool power tools) and cleaning accessories; with plug it-connection; antistatic; suitable for sanding applications; with rotating adapter and reducing sleeve with bayonet fitting; temperature-resistant to +70 °C; smooth</p>	27 /22	5	<1	201758	1	250,50	1	209004
 <p>D 32/22x10m-AS-GQ/CT for all power tools with D27 and D36 flange (all Festool power tools) and cleaning accessories; with plug it-connection; antistatic; suitable for sanding applications; with rotating adapter and reducing sleeve with bayonet fitting; temperature-resistant to +70 °C; smooth</p>	32 /22	10	<1	200051	1	360,70	1	209004

Antistatic rotating adapter

 <p>Rotating adapter, D 27 DAG-AS for antistatic suction hose D 27; antistatic; hose sleeve for connection to the inlet nozzle on the mobile dust extractor, outside dia. 58 mm diameter 27 mm</p>	452892	1	24,90	1	309001
 <p>Rotating adapter, D32/27 DAG-AS/CTR for D 27/32 antistatic suction hose; antistatic; hose sleeve for connection to the inlet nozzle on the mobile dust extractor, outside dia. 58 mm</p>	204919	1	25,00	1	309001
<p>Rotating adapter, D36 DAG-AS/CTR antistatic; hose sleeve for connection to the inlet nozzle on the mobile dust extractor, outside dia. 58 mm diameter 36 mm</p>	204920	1	30,20	1	309001

* Attention: Festool products with Bluetooth® technology are not available in all countries. For more information, please contact the official local Festool import partner. You can find the overview regarding our products and our partners worldwide on our website www.festool.com

PU = Packaging Units
SU = Shipping Units

¹⁾ Manufacturer's recommended retail price. Dealer prices may vary.

Dust extraction

Denomination and application		Order no.	PU	Trade price € excl. VAT per PU ¹⁾	SU	DG
	Rotating adapter, D 50 DAG-AS for antistatic suction hose D 50; antistatic; hose sleeve for connection to the inlet nozzle on the mobile dust extractor, outside dia. 58 mm	452896	1	35,90	1	309001
	Rotating adapter, D 36 DAG-AS-GQ/CT for antistatic suction hose D27/22x3.5 AS-GQ/CT and D27/22x5 AS-GQ/CT; antistatic; hose sleeve for connection to the inlet nozzle on the mobile dust extractor, outside dia. 58 mm diameter 36 mm	202931	1	30,20	1	309001
	Rotating adapter, D 50 DAG-AS-GQ/CT for antistatic suction hose D32/22x10 AS-GQ/CT; antistatic; hose sleeve for connection to the inlet nozzle on the mobile dust extractor, outside dia. 58 mm diameter 50 mm	203206	1	36,00	1	309001
Antistatic rotating angle adapter						
	Rotating angle adapter, D 27 DAG90-AS/CT for D 22 and D 27 antistatic suction hoses on CTL MINI and CTL MIDI up to BJ 08/2013 and CTL SYS; hose sleeve for connection to the inlet nozzle on the mobile dust extractor, outside dia. 58 mm diameter 27 mm	202505	1	25,30	1	309001
	Rotating angle adapter, D 32/27 DAG/90°-AS/CT for antistatic suction hose D 32/27 on CTL MINI and CTL MIDI; antistatic; for CTL MINI and CTL MIDI from YOM September 2013 to YOM December 2018; hose sleeve for connection to the inlet nozzle on the mobile dust extractor, outside dia. 58 mm	500673	1	27,00	1	309001
Reducing sleeve, antistatic						
	Connecting sleeve, D 27 DM-AS/CT for suction hose D 27; for all power tools with D27 flange and cleaning accessories; antistatic; hose connector for electric tool or suction nozzle; the bayonet fitting produces a secure connection between the mobile dust extractor and the power tool diameter 27 mm	202346	1	17,70	1	309001
	Connecting sleeve, D 27/22 DM-AS/CT for all power tools with D27 and D36 flange (all Festool power tools) and cleaning accessories; only for the smooth suction hoses with integrated plug-it-cable (GQ); antistatic; for connection to tools (power tools or suction nozzle); the bayonet fitting creates a secure connection between the mobile dust extractor and the power tool diameter 27 /22 mm	500668	1	17,70	1	309001
	Connecting sleeve, D 36 DM-AS/CT for suction hose D 36; for all power tools with D36 flange and cleaning accessories; antistatic; hose connector for electric tool or suction nozzle; the bayonet fitting produces a secure connection between the mobile dust extractor and the power tool diameter 36 mm	500670	1	22,60	1	309001
	Connecting sleeve, D 36/32 DM-AS for D 36/32 suction hose; for all power tools with D36 flange and cleaning accessories; antistatic; hose connector for electric tool or suction nozzle diameter 36 mm	500671	1	22,60	1	309001

* Attention: Festool products with Bluetooth® technology are not available in all countries.
For more information, please contact the official local Festool import partner.
You can find the overview regarding our products and our partners worldwide on our website www.festool.com

PU = Packaging Units
SU = Shipping Units

¹⁾ Manufacturer's recommended retail price.
Dealer prices may vary.

Dust extraction



Denomination and application		Order no.	PU	Trade price € excl. VAT per PU ¹⁾	SU	DG
	Connecting sleeve, D 36 DM-AS-LHS 225 for suction hose D 36; for long-reach sander PLANEX; antistatic; hose connector for electric tool or suction nozzle diameter 36 mm	495013	1	23,70	1	309001
	Connecting sleeve, D 36 DM-AS-B-LHS 225 for suction hose D 36; for long-reach sander PLANEX; antistatic; hose connector for electric tool or suction nozzle; for extremely light fillers: enables the suction effect of the PLANEX on the wall to be reduced to an absolute minimum diameter 36 mm	577100	1	23,90	1	309001
Reducing sleeve						
	Reducing sleeve, RM D 36/27-AS for suction hose D 36; for reducing to D 27 (machine); sleeve needs to be replaced diameter 27 mm	498528	1	17,50	1	309001
	Reducing sleeve, DC-D 36/27-AS for all VCP/CT; dust extraction end; reduction of dia. 36 to 27 mm; can be attached if necessary diameter 36 mm	768135	1	24,50	1	309001
Other accessories						
	Suction sleeve, D27 BP-AS/CT for improved control of all sanders, especially recommended for RTS 400, RTSC 400, DTS 400, DTSC 400, ETS 125, ETSC 125 and RO 90; prevents sticking on smooth surfaces diameter 27 mm	204822	1	19,40	1	309001
	Extraction adapter, D 50/D 36 for antistatic suction hose D 50; for connecting a D 50 suction hose to D 36 accessory	452897	1	16,40	1	309001
	Y-piece, D 50 SV-AS/D 50 V for D 50/D 36/D 27; antistatic; for connection of two dust extraction hoses; with blanking plug; for extractors that admit hazardous dust, simultaneous operation is not permitted	452898	1	44,00	1	309001

* Attention: Festool products with Bluetooth® technology are not available in all countries.
 For more information, please contact the official local Festool import partner.
 You can find the overview regarding our products and our partners worldwide on our website www.festool.com

PU = Packaging Units
 SU = Shipping Units

¹⁾ Manufacturer's recommended retail price.
 Dealer prices may vary.

Dust extraction

Denomination and application	Order no.	PU	Trade price		
			€ excl. VAT	SU	DG
 <p>Blanking plug, D 50/V for closing the inlet nozzle, for retrofitting all CTM/CTH mobile dust extractors</p>	452899	1	17,40	1	309001
 <p>Connector sleeve, D 50/D 50 VM-AS antistatic; for connecting suction hoses D 50/D 36/D 27; the reducing sleeve on D 27/D 36 hoses must be replaced with a D 36/D 27 rotating adapter</p>	493047	1	19,70	1	309001

CT accessories



 <p>HighPower battery pack, BP 18 Li 4,0 HPC-AS with AIRSTREAM function; lithium-ion (Li-ion) replacement battery pack for all Festool 18 V cordless tools (except CXS, TXS, ETSC 125, RTSC 400, DTSC 400) tensioner 18 V; capacity 4 Ah; Product weight 0,6 kg</p>	205033	1		1	
 <p>Adapter, AD-WCR adapter for attaching the WCR and/or service unit VE CT 26/36/48 for CT 48 EC and CT 48 EC B22</p>	498805	1	67,40	1	209002
 <p>Electrical outlet module, Modul-SD CT 26/36/48 for CT 26/36/48; electrical outlet with continuous power</p>	496142	1	54,20	1	209002
<p>Electrical outlet module, Modul-SD E/A CT 26/36/48 for CT 26/36/48</p>	496405	1	54,20	1	209002
 <p>Vacuum clamping nozzle, CT-W for CT mobile dust extractors and D 27 suction hose; flexible aid for temporary clamping and fixing of workpieces at horizontal and vertical areas max. clamping height 50 mm; max. load 3 kg; dimensions (L x W x H) 130 x 80 x 50 mm; Product weight 0,35 kg</p>	500312	1	40,50	1	209002
 <p>Shoulder strap, SYS-TG for CT-SYS and all Systainers T-LOC; easy transport of the CTL SYS and the Systainer T-LOC max. load 20 kg</p>	500532	1	20,70	1	214004
 <p>Energy box module, EAA CT 26/36/48 for CT 26/36/48; for connecting a CT mobile dust extractor with an energy box or boom arm</p>	496143	1	69,40	1	209002
 <p>Hose holder, CT-SG for CT 11, 22, 33, 44, 55; for storing the suction hose and mains cable; suitable hose sizes: plug it hose D 22 x 3,5 m / D 27 x 3,5 m / D 27 x 5 m / D 36 x 3,5 m / D 50 x 2,5 m / IAS 2-3500 AS; not suitable for CT 26/36/48 dimensions (L x W x H) 530 x 360 x 110 mm</p>	494388	1	51,40	1	209002

* Attention: Festool products with Bluetooth® technology are not available in all countries.
For more information, please contact the official local Festool import partner.
You can find the overview regarding our products and our partners worldwide on our website www.festool.com

PU = Packaging Units
SU = Shipping Units

¹⁾ Manufacturer's recommended retail price.
Dealer prices may vary.

Dust extraction



Denomination and application	Order no.	PU	Trade price € excl. VAT per PU ¹⁾	SU	DG
 <p>Sys-Adapter, SYS-AP-CT 36 HD for CT 36 E HD-AC, CT 26 HD, VCP 260 E-L AC, VCP 260 E-M AC, VCP 260 E-H, from YOM 2011; for VCP 360 E-L AC, VCP 360 E-M AC, VCP 480 E-L AC, VCP 480 E-M AC; for connecting Systainer to extractor</p>	768115	1	38,80	1	209005
 <p>Sealing slide, VS-CT AC/SRM45 PLANEX for CT AC / CT 36 AC PLANEX; ensures extreme vacuum in container; the filter undergoes thorough cleaning</p>	497926	1	53,20	1	209002
 <p>Tool holder, WHR-CT for CT 26/36; galvanised steel tool holder for sanders; for stable and ergonomic placement of an electrical or compressed air power tool</p>	496122	1	54,20	1	209002
 <p>Tool holder, WHR-CT LHS 2 for CT 36 PLANEX; with practical carrier handle; storage space for abrasives, interface pads and other small parts; easy to attach to Festool extractors with T-LOC or SYS-dock; fits all PLANEX long-reach sanders</p>	205274	1	34,40	1	209002
 <p>Handle, SB-CT MINI/MIDI-2/CT15 for CT MINI, CT MINI I, CT MIDI and CT MIDI I manufactured from 2019 onwards as well as CT 15; handle can be lowered when not in use; made of steel and aluminium pipes; with practical holder for storing cleaning accessories (hand tube, three extension pipes and floor nozzle) and parked position for plug-in suction hose with floor nozzle; cable holder</p>	204310	1	91,10	1	209002
 <p>Handle, SB-CT 26/36 for CT 26/36; for the convenient transportation of mobile dust extractors; with nozzle holder</p>	495802	1	82,00	1	209002
 <p>Handle, SB-CT 48 for CT 48; for the convenient transportation of mobile dust extractors; with nozzle holder</p>	497295	1	145,40	1	209002
CT compressed air accessories					
 <p>Compressed air module, DL CT 26/36/48 for CT 26/36/48; for upgrading E model mobile dust extractors; with additional compressed air automatic On and Off switching mechanism</p>	496141	1	234,50	1	209002

* Attention: Festool products with Bluetooth® technology are not available in all countries.
For more information, please contact the official local Festool import partner.
You can find the overview regarding our products and our partners worldwide on our website www.festool.com

PU = Packaging Units
SU = Shipping Units

¹⁾ Manufacturer's recommended retail price.
Dealer prices may vary.

Dust extraction

Denomination and application	Order no.	PU	Trade price € excl. VAT per PU ¹⁾	SU	DG
 <p>Service unit, VE-CT 26/36/48 for LE version of CT 26/36/48; pressure controller, condensate quick discharge, oiler and oil-free compressed air outlet with quick coupling</p>	495886	1	485,10	1	209002
 <p>Assembly set, MS DH VE-CT-ASA-CT26/36 for assembly of supply unit VE-CT 26/36 in conjunction with CT-ASA CT 26/36 SB</p>	496862	1	54,30	1	209002

* Attention: Festool products with Bluetooth® technology are not available in all countries.
For more information, please contact the official local Festool import partner.
You can find the overview regarding our products and our partners worldwide on our website www.festool.com

PU = Packaging Units
SU = Shipping Units

¹⁾ Manufacturer's recommended retail price.
Dealer prices may vary.

Dust extraction

Denomination and application	Order no.	PU	Trade price € excl. VAT per PU ¹⁾	SU	DG
CT main filter					
 <p>Main filter, HF-CT/2 for CT 11, 22, 33, 44, 55</p>	452923	2	36,50	1	209002
 <p>Main filter, HF-CT SYS for CTL SYS</p>	500558	1	19,40	1	209002
 <p>Filter element, HF-CT 17 for CT 17 E, VCP 170 E, VCP 320 E; used only for extraction of dust types which are not hazardous to health; for dry extraction</p>	769134	1	32,50	1	209005
 <p>Main filter, HF-CT-MINI/MIDI for CT MINI and CT MIDI manufactured until 2018</p>	456790	1	22,50	1	209002
 <p>Main filter, HF-CT MINI/MIDI-2/CT15 for CT MINI, CT MINI I, CT MIDI and CT MIDI I manufactured from 2019 onwards as well as CT 15; main filter surrounded by practical plastic frame; easy replacement of filter cartridge from outside without opening the mobile dust extractor</p>	204200	1	20,40	1	209002
 <p>Main filter, HF-CT 26/36/48 For CT 26/36/48 and TURBO II; Filters residual dust not retained by the filter bag so that clean air is directed back into the room; High-performance main filter; not suitable for mobile dust extractors with AUTOCLEAN function</p>	496170	1	36,50	1	209002
 <p>Main filter, HF-CT 26/36/48 HP for CT AC, VCP 260 AC, 360 AC, 480 AC; main filter optimised for cleaning with PTFE coating</p>	203759	1	57,50	1	209002
 <p>Main filter, HF CTH 26/48 for CTH 26, CTH 48; special filter complies with the requirements of dust class H dust class H</p>	498995	1	78,30	1	209002
CT Longlife main filter					
 <p>Long-life main filter, Longlife-HF-CT/2 for CT 11, 22, 33, 44, 55; used only for extraction of dust types which are not hazardous to health</p>	454869	2	78,50	1	209002

* Attention: Festool products with Bluetooth® technology are not available in all countries.
For more information, please contact the official local Festool import partner.
You can find the overview regarding our products and our partners worldwide on our website www.festool.com

PU = Packaging Units
SU = Shipping Units

¹⁾ Manufacturer's recommended retail price.
Dealer prices may vary.

Dust extraction









Denomination and application	Order no.	PU	Trade price € excl. VAT per PU ¹⁾	SU	DG
CT wet filter					
 <p>Wet filter, NF-CT MINI/MIDI for CT MINI and CT MIDI manufactured until 2018; for wet extraction</p>	456805	1	12,60	1	209002
 <p>Wet filter, NF-CT MINI/MIDI-2/CT15 for CT MINI, CT MINI I, CT MIDI and CT MIDI I manufactured from 2019 onwards as well as CT 15; for wet extraction; wet filter surrounded by practical plastic frame; easy replacement of filter cartridge from outside without opening the mobile dust extractor</p>	204202	1	20,40	1	209002
 <p>Wet filter, NF-CT/2 for CT 11, 22, 33, 44, 55; for wet extraction</p>	452924	2	17,10	1	209002
 <p>Wet filter, NF-CT 26/36/48 for CT 26/36/48; for wet extraction</p>	496169	1	17,20	1	209002
 <p>Wet filter, NF-CT 17 for CT 17 E, VCP 170 E, VCP 320 E, VCP 171 E-L, VCP 321 E-L; for wet extraction</p>	769135	1	23,90	1	209002
CT SELF CLEAN filter bags					
 <p>SELF CLEAN filter bag, SC FIS-CT SYS/5 for CTL SYS; optimum usage of the filter bag volume, with highly tear resistant filter fleece; SELF CLEAN filter bag made of cloth</p>	500438	5	17,10	1	409001
 <p>SELF CLEAN filter bag, SC FIS-CT MINI/5 for CTL MINI manufactured until 2018; optimum utilisation of filter bag capacity and consistently high suction power thanks to SELF CLEAN filter bag; FSC™-certified</p>	498410	5	19,60	1	409001
 <p>SELF CLEAN filter bag, SC FIS-CT MIDI/5 for CTL MIDI manufactured until 2018; optimum utilisation of filter bag capacity and consistently high suction power thanks to SELF CLEAN filter bag; FSC™-certified</p>	498411	5	28,70	1	409001
 <p>SELF CLEAN filter bag, SC-FIS-CT MINI/MIDI-2/5/CT15 for CT MINI, CT MINI I, CT MIDI and CT MIDI I manufactured from 2019 onwards as well as CT 15; optimum utilisation of filter bag volume thanks to SELF CLEAN filter material, optimised for cleaning; FSC™-certified max. filling volume 15 l</p>	204308	5	19,90	1	409001

* Attention: Festool products with Bluetooth® technology are not available in all countries.
For more information, please contact the official local Festool import partner.
You can find the overview regarding our products and our partners worldwide on our website www.festool.com

PU = Packaging Units
SU = Shipping Units

¹⁾ Manufacturer's recommended retail price.
Dealer prices may vary.

Dust extraction

Denomination and application		Order no.	PU	Trade price € excl. VAT per PU ¹⁾	SU	DG
	SELCLEAN filter bag, SC FIS-CT 26/5 for CT 26; optimum utilisation of filter bag capacity and consistently high suction power thanks to SELFCLEAN filter bag	496187	5	43,80	1	409001
	SELCLEAN filter bag, SC FIS-CT 36/5 for CT 36; optimum utilisation of filter bag capacity and consistently high suction power thanks to SELFCLEAN filter bag; for dry extraction	496186	5	47,90	1	409001
	SELCLEAN filter bag, SC FIS-CT 48/5 for CT 48; optimum utilisation of filter bag capacity and consistently high suction power thanks to SELFCLEAN filter bag	497539	5	51,90	1	409001
CTH safety filter bags						
	Safety filter bag, FIS-CTH 26/3 for CTH 26; double-layered	497541	3	62,30	1	409001
	Safety filter bag, FIS-CTH 48/3 for CTH 48; double-layered	497542	3	70,00	1	409001
CT disposal bags						
	Disposable bag, ENS-CT 26 AC/5 for CT 26 AC; not suitable for CT standard version (without AC)	496216	5	38,20	1	409001
	Disposable bag, ENS-CT 36 AC/5 for CT 36 AC/CTL 36 E AC HD; not suitable for CT standard version (without AC)	496215	5	41,60	1	409001
	Disposable bag, ENS-CT 48 AC/5 for CT/CTL/CTM 48 AC; not suitable for CT standard version (without AC)	497540	5	44,80	1	409001
CT filter bags						
	Filter bag, FIS-CT 17/5 for CT 17 E, VCP 170 E, VCP 171 E-L; double wall; for dry extraction	769136	5	31,60	1	409001
	Filter bag, FIS-CT 22/5 for CT 22; for dry extraction	452970	5	43,80	1	409001
	Filter bag, FIS-CT 22/20 for CT 22; for dry extraction	494631	20	156,30	1	409001
	Filter bag, FIS-CT 22 SP VLIIES/5 for CT 22; with spunbond outer layer; extremely tearproof; for extracting fine dust particles	456870	5	55,80	1	409001
	Filter bag, FIS-CT 33/5 for CT 33; for dry extraction	452971	5	47,90	1	409001

* Attention: Festool products with Bluetooth® technology are not available in all countries.
For more information, please contact the official local Festool import partner.
You can find the overview regarding our products and our partners worldwide on our website www.festool.com





PU = Packaging Units
SU = Shipping Units

¹⁾ Manufacturer's recommended retail price.
Dealer prices may vary.

Dust extraction

Denomination and application	Order no.	PU	Trade price		
			€ excl. VAT	SU	DG
 <p>Filter bag, FIS-CT 33/20 for CT 33; for dry extraction</p>	494632	20	170,90	1	409001
 <p>Filter bag, FIS-CT 33 SP VLIES/5 for CT 33; with spunbond outer layer; extremely tearproof; for extracting fine dust particles</p>	456871	5	61,40	1	409001
 <p>Filter bag, FIS-CT 44/5 for CT 44</p>	452972	5	51,90	1	409001
 <p>Filter bag, FIS-CT 44 SP VLIES/5 for CT 44; with spunbond outer layer; extremely tearproof; for extracting fine dust particles</p>	456874	5	66,10	1	409001
 <p>Filter bag, FIS-CT 55/5 for CT 55</p>	452973	5	55,80	1	409001

CT Longlife filter bags



 <p>Longlife filter bag, Longlife-FIS-CT SYS for CTL SYS; used only for extraction of dust types which are not hazardous to health; from high strength, 3-layer polyester fleece with a long service life; multiple filter bag for disposal of dust; Not recommended for fine dust</p>	500642	1	66,10	1	209002
 <p>Longlife filter bag, Longlife-FIS-CTL MINI for CT MINI manufactured until 2018; used only for extraction of dust types which are not hazardous to health; from high strength, 3-layer polyester fleece with a long service life; Not recommended for fine dust</p>	499703	1	85,10	1	209002
 <p>Longlife filter bag, Longlife-FIS-CTL MIDI for CT MIDI manufactured until 2018; used only for extraction of dust types which are not hazardous to health; from high strength, 3-layer polyester fleece with a long service life; Not recommended for fine dust</p>	499704	1	121,80	1	209002
 <p>Longlife filter bag, LL-FIS-CT MINI/MIDI-2/CT15 for CT MINI, CT MINI I, CT MIDI and CT MIDI I manufactured from 2019 onwards as well as CT 15; used only for extraction of dust types which are not hazardous to health; from high strength, 3-layer polyester fleece with a long service life; Not recommended for fine dust max. filling volume 15 l</p>	204309	1	139,20	1	209002

* Attention: Festool products with Bluetooth® technology are not available in all countries.
For more information, please contact the official local Festool import partner.
You can find the overview regarding our products and our partners worldwide on our website www.festool.com

PU = Packaging Units
SU = Shipping Units

¹⁾ Manufacturer's recommended retail price.
Dealer prices may vary.

Dust extraction

Denomination and application	Order no.	PU	Trade price € excl. VAT per PU ¹⁾	SU	DG	
	Longlife filter bag, Longlife-FIS-CT 26 for CT 26; used only for extraction of dust types which are not hazardous to health; from high strength, 3-layer polyester fleece with a long service life; Not recommended for fine dust	496120	1	168,80	1	209002
	Longlife filter bag, Longlife-FIS-CT 36 for CT 36; used only for extraction of dust types which are not hazardous to health; from high strength, 3-layer polyester fleece with a long service life; Not recommended for fine dust	496121	1	177,70	1	209002
	Longlife filter bag, Longlife-FIS-CT 48 for CT 48; used only for extraction of dust types which are not hazardous to health; from high strength, 3-layer polyester fleece with a long service life; Not recommended for fine dust	498506	1	186,50	1	209002
	Longlife filter bag, Longlife-FIS-CT 22 for CT 22; used only for extraction of dust types which are not hazardous to health; Not recommended for fine dust; from high strength, 3-layer polyester fleece with a long service life	456737	1	168,80	1	209002
	Longlife filter bag, Longlife-FIS-CT 33 for CT 33; used only for extraction of dust types which are not hazardous to health; from high strength, 3-layer polyester fleece with a long service life; Not recommended for fine dust	456738	1	177,70	1	209002

SR-filters and filter bags

BIA-approved





	Absolute filter, AB-FI SRM 45/70 for SRM 45 LE-EC, SRM 70 LE-EC	493826	1	65,60	1	209001
	Main filter, NANO HF-SRM 45-LHS 225 for SRM 45 E-PLANEX, VCP 450 E-L, VCP 450 E-M; Nano	496406	1	61,80	1	209001
	Absolute filter, AB-FI/U for SR 5, SR 200, SR 201	485808	1	46,70	1	209001
	Absolute filter, AB-FI for SR151	488461	1	60,70	1	209001
	Absolute filter, AB-FI/C for SR 6, SR 12, SR 14, SR 202, SR 203, SR 212, SR 301, SR 302, SR 303; application category C/M	486241	1	63,80	1	209001
	Filter bag, FIS-SRM 45 /5 for SRM 45 LE-EC	493775	5	51,60	1	409001
	Filter bag, FIS-SRM 45-LHS 225 /5 for SRM 45 E-PLANEX, VCP 450 E-L, VCP 450 E-M	495014	5	42,40	1	409001

* Attention: Festool products with Bluetooth® technology are not available in all countries.
For more information, please contact the official local Festool import partner.
You can find the overview regarding our products and our partners worldwide on our website www.festool.com

PU = Packaging Units
SU = Shipping Units

¹⁾ Manufacturer's recommended retail price.
Dealer prices may vary.

Dust extraction

Denomination and application	Order no.	PU	Trade price € excl. VAT per PU ¹⁾	SU	DG
 <p>Disposable bag, ENS-SRM 45-LHS 225/5 for SRM 45 E-PLANEX, VCP 450 E-L, VCP 450 E-M</p>	495015	5	36,90	1	409001
 <p>Filter bag, FIS-SRM 70 /5 for SRM 70 LE-EC</p>	493777	5	66,40	1	409001
 <p>Filter bag, FIS-SRH 45 /5 for SRH 45 E</p>	493776	5	168,90	1	409001
 <p>Two-ply filter bag, FIS-SR 5/6 /5 for SR 5, SR 6; double-layered</p>	483143	5	48,60	1	409001
<p>Two-ply filter bag, FIS-SR 12/14 /5 for SR 12, SR 14</p>	483142	5	61,50	1	409001
<p>Two-ply filter bag, FIS-SR 150 /5 for SR 151, SRM 152</p>	488460	5	48,60	1	409001
<p>Two-ply filter bag, FIS-SR 200 /5 for SR 200, SR 201, SR 203</p>	487070	5	52,90	1	409001
<p>Two-ply filter bag, FIS-SR 300 /5 for SR 301, SR 303, SRM 312</p>	487790	5	68,60	1	409001
<p>Two-ply filter bag, FIS-SR 15 /5 for SR15, SR12, SR14; for substances with dust emission limits and carcinogenic substances as defined by GefStoffV35; BIA-approved</p>	483889	5	101,60	1	409001
<p>Two-ply filter bag, FIS-SR 202 /5 for SR 202, SR 212, SRH 204, SR 200, SR 201, SR 203</p>	487482	5	90,60	1	409001

* Attention: Festool products with Bluetooth® technology are not available in all countries.
For more information, please contact the official local Festool import partner.
You can find the overview regarding our products and our partners worldwide on our website www.festool.com

PU = Packaging Units
SU = Shipping Units

¹⁾ Manufacturer's recommended retail price.
Dealer prices may vary.





Denomination and application		Order no.	PU	Trade price € excl. VAT per PU ¹⁾	SU	DG
ErgoFix stirrers						
	Stirrer, MX 1000 RE EF HS2 stirrer rod HS 2 120x600 M14 (769030), ErgoFix adapter (769091), double open-ended wrench, MX-A extraction (576759)	575806	1	269,00	1	111001
	Stirrer, MX 1000 RE EF HS3R stirrer rod HS 3 120x600 R M14 (767887), ErgoFix adapter (769091), double open-ended wrench, MX-A extraction (576759)	575807	1	269,00	1	111001
	Stirrer, MX 1200 RE EF HS2 stirrer rod HS 2 140x600 M14 (769031), ErgoFix adapter (769091), double open-ended wrench, MX-A extraction (576759)	575813	1	375,00	1	111001
	Stirrer, MX 1200 RE EF HS3R stirrer rod HS 3 140x600 R M14 (768708), ErgoFix adapter (769091), double open-ended wrench, MX-A extraction (576759)	576743	1	375,00	1	111001
	Stirrer, MX 1200/2 RE EF HS3R stirrer rod HS 3 140x600 R M14 (768708), ErgoFix adapter (769091), double open-ended wrench, MX-A extraction (576759)	575815	1	459,00	1	111001
Stirrer, MX 1600/2 RE EF HS3R stirrer rod HS 3 160x600 R M14 (768710), ErgoFix adapter (769091), double open-ended wrench, MX-A extraction (576759)	575818	1	518,00	1	111001	

DUO stirrers						
	Stirrer, MX 1600/2 REQ DUO DOUBLE one pair of stirring rods, HS 3 Double 140 x 600 (768800), MX-A extraction (576759)	575822	1	713,00	1	111001





Stirring rods

HS 3 R helical stirrer with ring for stiff materials with a high viscosity, mortar, concrete, cement and lime plaster, mounting binder, screed, quartz-filled epoxy resin, bitumen, thick coatings; upward mixing action, "screws" itself into the material; 3 clockwise spirals						
	Spiral stirrer, HS 3 120x600 R M14 for MX 1000, MX 1000/2, MXP 800, MXP 1000, MXP 1002 material quantity 10 – 25 kg; diameter 120 mm; length 600 mm	767887	1	37,60	1	511001
	Spiral stirrer, HS 3 140x600 R M14 for MX 1200, MX 1200/2, MXP 1200, MXP 1202 material quantity 25 – 40 kg; diameter 140 mm; length 600 mm	768708	1	42,00	1	511001
	Spiral stirrer, HS 3 160x600 R M14 for MX 1600/2, MXP 1602 material quantity 30 – 60 kg; diameter 160 mm; length 600 mm	768710	1	48,00	1	511001

Stirring

	Denomination and application	Order no.	PU	Trade price		
				€ excl. VAT	SU	DG
per PU ¹⁾						
	Spiral stirrer HS 2 for viscous materials, tile cement, filling compounds, flooring mixtures, ready-mix plasters, screed, smoothing cement, filling mixtures; 2 spirals					
	Spiral stirrer, HS 2 70x400 SW 8 for chuck with clamping range ≥10mm material quantity – 8 kg; diameter 70 mm; length 400 mm	769025	1	14,30	1	511001
	Spiral stirrer, HS 2 85x400 SW 8 for chuck with clamping range ≥10mm material quantity 8 – 10 kg; diameter 85 mm; length 400 mm	769026	1	15,30	1	511001
	Spiral stirrer for viscous materials, tile cement, filling compounds, flooring mixtures, ready-mix plasters, screed, smoothing cement, filling mixtures; 2 spirals					
	Spiral stirrer, HS 2 100x400 SW 8 for chuck with clamping range ≥10mm material quantity 10 – 15 kg; diameter 100 mm; length 400 mm	769027	1	19,60	1	511001
	Spiral stirrer, HS 2 120x600 SW 10 for chuck with clamping range ≥13mm material quantity 15 – 20 kg; diameter 120 mm; length 600 mm	769028	1	24,70	1	511001
	Spiral stirrer, HS 2 120x600 M14 for MX 1000, MX 1000/2, MXP 800, MXP 1000, MXP 1002 material quantity 10 – 20 kg; diameter 120 mm; length 600 mm	769030	1	29,10	1	511001
	Spiral stirrer, HS 2 140x600 M14 for MX 1200, MX 1200/2, MXP 1200, MXP 1202 material quantity 20 – 40 kg; diameter 140 mm; length 600 mm	769031	1	31,40	1	511001
	Spiral stirrer, HS 2 160x600 M14 for MX 1600/2, MXP 1602 material quantity 30 – 60 kg; diameter 160 mm; length 600 mm	769032	1	43,70	1	511001
	Stirrer CS for filling mixtures and smoothing cement, sealant, adhesives, for stirring without trapping air (no air bubbles)					
	Stirrer, CS 120x600 SW10 for chuck with clamping range ≥13mm material quantity 10 – 25 kg; diameter 120 mm; length 600 mm	769119	1	30,20	1	511001
	Stirrer, CS 120x600 M14 for MX 1000, MX 1000/2, MXP 800, MXP 1000, MXP 1002 material quantity 10 – 20 kg; diameter 120 mm; length 600 mm	769118	1	32,40	1	511001
	Stirrer, CS 140x600 M14 for MX 1200, MX 1200/2, MXP 1200, MXP 1202 material quantity 20 – 40 kg; diameter 140 mm; length 600 mm	769117	1	36,50	1	511001
	Stirrer, CS 160x600 M14 for MX 1600/2, MXP 1602 material quantity 40 – 60 kg; diameter 160 mm; length 600 mm	769116	1	40,60	1	511001
	Spiral stirrer for thin materials, gypsum plaster, emulsion paint, clear coats, wall paints, sealing compounds; mixing from top to bottom. Solid materials are well mixed. Material does not spray; 3 anticlockwise spirals					
	Spiral stirrer, HS 3 120x600 L M14 for MX 1000, MX 1000/2, MXP 800, MXP 1000, MXP 1002 material quantity 10 – 25 kg; diameter 120 mm; length 600 mm	767921	1	37,60	1	511001
	Spiral stirrer, HS 3 140x600 L M14 for MX 1200, MX 1200/2, MXP 1200, MXP 1202 material quantity 25 – 40 kg; diameter 140 mm; length 600 mm	768138	1	42,00	1	511001
	Spiral stirrer, HS 3 160x600 L M14 for MX 1600/2, MXP 1602 material quantity 30 – 60 kg; diameter 160 mm; length 600 mm	768709	1	48,00	1	511001

Stirring

Denomination and application		Order no.	PU	Trade price € excl. VAT per PU ¹⁾	SU	DG
Disk stirrer WS for liquid materials, paints, varnishes, wall paint, emulsion paint, wallpaper paste, glue, tile cement						
	Disc stirrer, WS 2 60x350 SW 8 for chuck with clamping range ≥10mm material quantity – 5 kg; diameter 60 mm; length 350 mm	769033	1	12,70	1	511001
	Disc stirrer, WS 2 80x350 SW 8 for chuck with clamping range ≥10mm material quantity 5 – 10 kg; diameter 80 mm; length 350 mm	769034	1	14,40	1	511001
	Disc stirrer, WS 2 100x600 SW 10 for chuck with clamping range ≥13mm material quantity 10 – 15 kg; diameter 100 mm; length 600 mm	769035	1	22,80	1	511001
Disk stirrer for liquid materials, paints, varnishes, wall paint, emulsion paint, wallpaper paste, glue, tile cement						
	Disc stirrer, WS 2 120x600 M14 for MX 1000, MX 1000/2, MXP 800, MXP 1000, MXP 1002 material quantity 10 – 20 kg; diameter 120 mm; length 600 mm	768122	1	27,60	1	511001
	Disc stirrer, WS 2 140x600 M 14 for MX 1200, MX 1200/2, MXP 1200, MXP 1202 material quantity 20 – 30 kg; diameter 140 mm; length 600 mm	769022	1	35,00	1	511001
	Disc stirrer, WS 2 160x600 M 14 for MX 1600/2, MXP 1602 material quantity 30 – 60 kg; diameter 160 mm; length 600 mm	769036	1	42,30	1	511001
Round stirrer for liquid materials, wall and emulsion paints, standard paste, sealing compounds, clear coats, bitumen, sludge						
	Round stirrer, RS 2 85x400 SW 8 for chuck with clamping range ≥10mm material quantity – 15 kg; diameter 85 mm; length 400 mm	769023	1	14,30	1	511001
	Round stirrer, RS 2 100x600 SW 10 for chuck with clamping range ≥13mm material quantity 15 – 25 kg; diameter 100 mm; length 600 mm	769024	1	18,10	1	511001
	Round stirrer, RS 2 100x600 M14 for MX 1000, MX 1000/2, MXP 800, MXP 1000, MXP 1002 material quantity 10 – 25 kg; diameter 100 mm; length 600 mm	769020	1	22,80	1	511001
	Round stirrer, RS 2 120x600 M14 for MX 1000, MX 1000/2, MXP 800, MXP 1000, MXP 1002 material quantity 20 – 40 kg; diameter 120 mm; length 600 mm	769021	1	24,80	1	511001
Stirring rod for MX 1600/2 DUO						
	Stirring rod, HS 3 COMBI 140x600 FF for MX 1600/2 DUO, MXP 1602 DUO; for liquid and viscous materials; lower part of the stirrer cage raises mixture from the bottom of the container upwards. Upper part of the stirrer cage pushes mixture downwards diameter 140 mm; length 600 mm; material quantity 30 - 60 kg	768092	1	153,60	1	411001
	Stirring rod, HS 3 DOUBLE 140x600 FF for MX 1600/2 DUO, MXP 1602 DUO; For high viscosity or heavy materials needing thorough mixing; two stirrer rods, each with three helixes, counter-rotate. Mixture is pulverised and whisked diameter 140 mm; length 600 mm; material quantity 30 - 60 kg	768800	1	153,60	1	411001
Spiral stirrer with anticlockwise motion for thin mixtures; connecting thread M14						
	Spiral stirrer, WR 120 L for RW 1000; anticlockwise stirring rod; up to 25 kg height of mixing head 140 mm; diameter 120 mm; length 625 mm	484285	1	78,00	1	411001
	Spiral stirrer, WR 140 L for RW 1000; anticlockwise stirring rod; up to 50 kg height of mixing head 180 mm; diameter 140 mm; length 625 mm	484286	1	90,80	1	411001

* Attention: Festool products with Bluetooth® technology are not available in all countries.
For more information, please contact the official local Festool import partner.
You can find the overview regarding our products and our partners worldwide on our website www.festool.com

PU = Packaging Units
SU = Shipping Units

¹⁾ Manufacturer's recommended retail price.
Dealer prices may vary.

Stirring



Denomination and application	Order no.	PU	Trade price			
			€ excl. VAT per PU ¹⁾	SU	DG	
Spiral stirrer with clockwise motion for viscous materials; connecting thread M14						
	Spiral stirrer, WR 120 R for RW 1000; clockwise stirring rod; up to 25 kg height of mixing head 110 mm; diameter 120 mm; length 625 mm	434285	1	78,00	1	411001
	Spiral stirrer, WR 140 R for RW 1000; clockwise stirring rod; up to 50 kg height of mixing head 145 mm; diameter 140 mm; length 625 mm	484288	1	90,80	1	411001

Accessories for stirrers



Mixing centre, stirrer						
	Adapter ring, A-GD 57/43 for holding stirrers with a collar dia. 43 mm in MS 57	768712	1	13,70	1	201007
	Fixed rod, CL-MS for attaching mixing containers to the stirrer stand MS 57; suitable for container heights between 300 mm and 500 mm	769048	1	89,00	1	211002

Dust extraction						
	Dust extraction, MX - A for all MX stirrers and CT/CTL/CTM mobile dust extractors; for dust-free work with the stirrers dust extraction connection dia. 36 / 27 mm	576759	1	52,10	1	211002

Adapter accessories

ErgoFix adapter						
	Adapter, AD-EF-M14/80 ErgoFix with M14 thread; For holding Festool stirrer rods M14 at ErgoFix stirrers stroke length 80 mm	769091	1	16,10	1	211002
	Adapters					
 	Adapter, MA M14-M14 fitting stirrer rods with internal thread	769148	1	12,80	1	311001
	Adapter, MAI M14-M14 fitting Festool stirring rods with external thread to stirrers (RW 1000)	769151	1	14,40	1	311001

Stirring

Denomination and application	Order no.	PU	Trade price € excl. VAT per PU ¹⁾	SU	DG
 <p>Adapter, AD-D10/M14 for Festool stirrers: to mount in a drill chuck; for sanding disc with M14 thread: for mounting in drilling and boring machines; for polishing pad Ø 80: for use in cordless drills camping flange dia. 10 mm</p>	483944	1	21,10	1	311001
 <p>Guide extension, PL 400 M14/M14 for extending all stirrer rods by 400 mm, thread M14; M14 thread on both ends</p>	769037	1	23,00	1	311001

* Attention: Festool products with Bluetooth® technology are not available in all countries.
For more information, please contact the official local Festool import partner.
You can find the overview regarding our products and our partners worldwide on our website www.festool.com

PU = Packaging Units
SU = Shipping Units

¹⁾ Manufacturer's recommended retail price.
Dealer prices may vary.

Denomination and application

Order no. PU Trade price
€ excl. VAT SU DG
per PU ¹⁾

Working light

SYSLITE DUO working light

Unique LED configuration for 180° scattering angle and homogeneous illumination; High illuminating power (8000 lm) for brilliant lighting of a large surface area; Daylight-like colour (5000 K)



Working light SYSLITE, DUO	200164	1	312,00	1	115002
Working light SYSLITE, DUO-Plus Systainer SYS3 M 237 (204843)	576406	1	344,00	1	115002
Working light SYSLITE, DUO-Set ST DUO 200 tripod (200038), Systainer SYS3 M 237 (204843)	576402	1	495,00	1	115002

Accessories for SYSLITE DUO working light

Tripod, ST DUO 200

for SYSLITE DUO; continuously height-adjustable from 150 to 200 cm via two pull-outs, folds to save space and easy to transport at just 5,6 kg



Tripod, ST DUO 200	200038	1	151,20	1	215005
---------------------------	--------	---	--------	---	--------

Surface control light

STL 450 inspection light

Surface control light SYSLITE, STL 450
bag (203639)

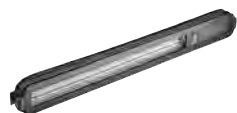

Surface control light SYSLITE, STL 450	201937	1	305,00	1	115002
---	--------	---	--------	---	--------

Surface control light SYSLITE, STL 450-Set

grazing light in bag; AD-ST DUO 200 adapter (201936), ST DUO 200 tripod (200038), bag (203639)



Surface control light SYSLITE, STL 450-Set	202911	1	541,00	1	115002
---	--------	---	--------	---	--------

Accessories for STL 450

Adapter, AD-ST DUO 200

for SYSLITE STL 450 inspection light; for attaching to the ST DUO 200 tripod
Product weight 1,1 kg



Adapter, AD-ST DUO 200	201936	1	84,60	1	215005
-------------------------------	--------	---	-------	---	--------

Bag, ST-BAG

for the ST DUO 200 tripod, STL 450 surface control light and AD-ST DUO 200 adapter; transport bag with shoulder strap and carry handle; for storage and simple transport of the tripod for the SYSLITE DUO and the SYSLITE STL surface control light; with practical side pockets for additional system accessories



Bag, ST-BAG	203639	1	74,50	1	215005
--------------------	--------	---	-------	---	--------

Illuminating

Denomination and application		Order no.	PU	Trade price € excl. VAT per PU ¹⁾	SU	DG
Working light						
SYSLITE KAL II working light						
	Working light SYSLITE, KAL II integrated battery 7.2 V, car charger adapter, 230 V adapter, transport bag	500721	1	184,00	1	115002
	Working light SYSLITE, KAL II-Set integrated battery 7.2 V, car charger adapter, 230 V adapter, magnetic spherical head with flat disc (499814), transport bag	499815	1	218,00	1	115002
Working light SYSLITE						
	Working light SYSLITE, SYSLITE UNI scaffolding holder, without charger, without battery pack	769079	1	86,60	1	201008
Accessories for working light						
Accessories for working light SYSLITE KAL						
	Magnetic spherical head, MA KAL for Festool guide rail clamps; spherical head can be rotated 360°; for flexible positioning of the work light SYSLITE KAL and KAL II; pad for external stand magnetic holding force 16 kg	499814	1	54,20	1	215005

* Attention: Festool products with Bluetooth® technology are not available in all countries.
For more information, please contact the official local Festool import partner.
You can find the overview regarding our products and our partners worldwide on our website www.festool.com

PU = Packaging Units
SU = Shipping Units



¹⁾ Manufacturer's recommended retail price.
Dealer prices may vary.



Systainer

Systainer³ M

	Dimensions with adjustable legs (L x W x H) mm	Inner dimensions (L x W x H) mm	Volume l	Load capacity kg	Load capacity (connected) kg					
 <p>SYS3 M 112 incl. cover for label field</p>	396 x 296 x 112	389 x 275 x 71	7,7	20	40	204840	1	58,50	1	214001
 <p>SYS3 M 137 for practical transportation of hand tools, consumable materials and accessories; incl. cover for label field</p>	396 x 296 x 137	389 x 275 x 96	10,4	20	40	204841	1	62,80	1	214001
 <p>SYS3 M 187 incl. cover for label field</p>	396 x 296 x 187	389 x 275 x 146	15,9	20	40	204842	1	67,10	1	214001
 <p>SYS3 M 237 incl. cover for label field</p>	396 x 296 x 237	389 x 275 x 196	21,4	20	40	204843	1	71,40	1	214001
 <p>SYS3 M 337 incl. cover for label field</p>	396 x 296 x 337	389 x 275 x 296	32,4	20	40	204844	1	75,70	1	214001
 <p>SYS3 M 437 incl. cover for label field</p>	396 x 296 x 437	389 x 275 x 394	43,1	20	40	204845	1	79,80	1	214001
 <p>SYS3 M 112 MFT-FX for MFT 3, MW 1000 mobile workshop and T-LOC-SYS-MFT; round and flat workpieces can be securely clamped on the MFT/3 thanks to the vertical fixing system; compatible with the MFT clamping system: MFT/3, MW 1000 and T-LOC SYS-MFT; 2 x FS-HZ 160 lever clamp (491594), 2 x MFT-HZ 80 lever clamp (577132), 2 x low-profile stop, 4 x MFT bench clamps, Deep-drawer insert, Systainer SYS3 M 112, blue</p>	396 x 296 x 112	-	-	-	-	577131	1	295,00	1	205005

Systainer and transport systems

Denomination and application							Order no.	PU	Trade price € excl. VAT per PU ¹⁾	SU	DG
Systainer³ L											
	SYS3 L 137 with a broader base area for even more space; incl. cover for label field	Dimensions with adjustable legs (L x W x H) mm 508 x 296 x 137	Inner dimensions (L x W x H) mm 501 x 275 x 94	Volume l 13,2	Load capacity kg 20	Load capacity (connected) kg 40	204846	1	76,20	1	214001
	SYS3 L 187 with a broader base area for even more space; incl. cover for label field	508 x 296 x 187	501 x 275 x 144	20,2	20	40	204847	1	81,50	1	214001
	SYS3 L 237 with a broader base area for even more space; incl. cover for label field	508 x 296 x 237	501 x 275 x 194	27,4	20	40	204848	1	86,90	1	214001



Systainer³ Organizer M											
		Dimensions with adjustable legs (L x W x H) mm	Inner dimensions (L x W x H) mm	Volume l	Load capacity kg	Permitted lid load kg					
	SYS3 ORG M 89 without plastic containers; clear organisation and transportation solution for small parts with transparent lid	396 x 296 x 89	389 x 246 x 60	7,4	20	100	204852	1	58,50	1	214015
	SYS3 ORG M 89 22xESB clear organisation and transportation solution for small parts with transparent lid; 13 x plastic container 50 x 50 x 68, 8 x plastic container 50 x 100 x 68, plastic container 100 x 150 x 68	396 x 296 x 89	389 x 246 x 60	7,4	20	100	204853	1	73,50	1	214015
	SYS3 ORG M 89 6xESB clear organisation and transportation solution for small parts with transparent lid; plastic container 50 x 50 x 68, plastic container 50 x 100 x 68, 3 x plastic container 100 x 150 x 68, plastic container 100 x 350 x 68	396 x 296 x 89	389 x 246 x 60	7,4	20	100	204854	1	73,50	1	214015

* Attention: Festool products with Bluetooth® technology are not available in all countries.
For more information, please contact the official local Festool import partner.
You can find the overview regarding our products and our partners worldwide on our website www.festool.com



PU = Packaging Units
SU = Shipping Units

¹⁾ Manufacturer's recommended retail price.
Dealer prices may vary.

Systainer and transport systems

Denomination and application	Order no.	PU	Trade price € excl. VAT per PU ¹⁾	SU	DG
 <p>SYS3 M 89 ORG CE-SORT for all Festool cordless drills with FastFix interface; D 3 CE/W spiral wood drill bits (492512), D 4 CE/W spiral wood drill bits (492513), D 5 CE/W spiral wood drill bits (492514), D 6 CE/W spiral wood drill bits (492515), D 8 CE/W spiral wood drill bits (492517), D 10 CE/W spiral wood drill bits (492518), CENTROTEC BH 60 CE Imp magnetic bit holder (498974), extra-long CENTROTEC magnetic bit holder BV 150 CE (492540), deburring countersink QLS D2-8 CE (492520), deburring countersink QLS D5-15 CE (492521), BTA HW D5 CE drill bit with depth stop (492522), drill countersink with depth stop, BSTA HS D3.5 CE (492523), centering bit ZB HS D5 EURO CE (492525), hook driver HD D18 CE (492526), twinBOX BB-MIX range of bits (496936), drill bit case BKS D3-8 CE/W-K (495130), 12 x 100 mm CENTROTEC bits PZ1/PZ2/PZ3/PH1/PH2/PH3/TX15/TX20/TX25/TX30/SZ 0.8 x 5.5/SZ 1.2 x 6.5, 60 x 25 mm bits, five units each: PZ1/PZ2/PZ3/PH1/PH2/PH3/TX10/TX15/TX20/TX25/TX30/TX40, CENTROTEC BHS 60 CE rapid-change bit holder (205097), screwdriver SD-CE-DRIVE-UNI (200140), CENTROTEC tool chuck (492135), Systainer SYS3 ORG M 89 (204852)</p>	576804	1	471,30	1	401003
 <p>SYS3 M 112 RA 1/2" fine-toothed reversible ratchet, 72 teeth, backswing angle: 5°, 1/2" guide extension 100 mm and 250 mm, 1/2" universal joint, 1/2" socket wrench insert, consisting of SW 13/14/15/16/17/18/19/21/22, 1/4" fine-toothed reversible ratchet, 72 teeth, backswing angle: 5°, 1/4" guide extension 75 mm and 150 mm, 1/4" universal joint, 1/4" socket wrench insert, consisting of SW 5/6/7/8/9/10/11/12/13, fine-toothed reversible bit ratchet, 60 teeth, backswing angle: 6°, includes 1/4" adapter for socket spanners, "Stubby" screwdriver with bit holder, 20 x 25 mm bits (1 x PH 1, 1 x PH 2, 1 x PH 3, 1 x PZ 1, 1 x PZ 2, 1 x PZ 3, 1 x TX 10, 1 x TX 15, 1 x TX 20, 1 x TX 25, 1 x TX 30, 1 x TX 40, 1 x HEX 2, 1 x HEX 2.5, 1 x HEX 3, 1 x HEX 4, 1 x HEX 5, 1 x HEX 6, 1 x SZ 0.8, 1 x SZ 1.2), Systainer SYS3 M 112, blue, EPP tool inlay; Dimensions with adjustable legs (L x W x H) 396 x 296 x 112 mm</p>	577134	1	206,00	1	501001

Systainer³ Organizer L

	Dimensions with adjustable legs (L x W x H) mm	Inner dimensions (L x W x H) mm	Volume l	Load capacity kg	Permitted lid load kg					
 <p>SYS3 ORG L 89 without plastic containers; with a broader base area for even more space; clear organisation and transportation solution for small parts with transparent lid</p>	508 x 296 x 89	501 x 278 x 60	9,7	20	100	204855	1	70,90	1	214015
 <p>SYS3 ORG L 89 20xESB with a broader base area for even more space; clear organisation and transportation solution for small parts with transparent lid; 10 x plastic container 50 x 50 x 68, 6 x plastic container 50 x 100 x 68, 2 x plastic container 100 x 100 x 68, plastic container 100 x 150 x 68, plastic container 150 x 150 x 68</p>	508 x 296 x 89	501 x 278 x 60	9,7	20	100	204856	1	85,80	1	214015
 <p>SYS3 ORG L 89 10xESB with a broader base area for even more space; clear organisation and transportation solution for small parts with transparent lid; plastic container 50 x 50 x 68, 4 x plastic container 50 x 100 x 68, plastic container 100 x 100 x 68, 3 x plastic container 100 x 150 x 68, plastic container 100 x 350 x 68</p>	508 x 296 x 89	501 x 278 x 60	9,7	20	100	204857	1	85,80	1	214015

* Attention: Festool products with Bluetooth® technology are not available in all countries.
For more information, please contact the official local Festool import partner.
You can find the overview regarding our products and our partners worldwide on our website www.festool.com

PU = Packaging Units
SU = Shipping Units

¹⁾ Manufacturer's recommended retail price.
Dealer prices may vary.

Systainer and transport systems

Denomination and application		Order no.	PU	Trade price € excl. VAT per PU ¹⁾	SU	DG
Accessories for Systainer³ Organizer M/L						
all variants: For Systainer ³ Organizer, for clear storage and organisation, boxes excluding content, in a bag						
		Dimensions (L x W x H) mm				
	Box 50x50x68/10 for Systainer ³ Organizer; for clear storage and organisation; boxes excl. content	50 x 50 x 68	204858	10	13,00	1 214003
	Box 50x100x68/10 for Systainer ³ Organizer; for clear storage and organisation; boxes excl. content	50 x 100 x 68	204859	10	14,10	1 214003
	Box 100x100x68/6 for Systainer ³ Organizer; for clear storage and organisation; boxes excl. content	100 x 100 x 68	204860	6	13,00	1 214003
	Box 100x150x68/6 for Systainer ³ Organizer; for clear storage and organisation; boxes excl. content	100 x 150 x 68	204861	6	14,10	1 214003
	Box 100x350x68/2 for Systainer ³ Organizer; for clear storage and organisation; boxes excl. content	100 x 350 x 68	204862	2	15,10	1 214003
	Box 150x150x68/6 for Systainer ³ Organizer; for clear storage and organisation; boxes excl. content	150 x 150 x 68	204863	6	10,80	1 214003
	Box 150x300x68/2 for Systainer ³ Organizer; for clear storage and organisation; boxes excl. content	150 x 300 x 68	204864	2	12,00	1 214003
	BS-BOX/25 for all plastic containers with a height of 68 mm; for individual labelling	-	204949	25	11,50	1 214003

* Attention: Festool products with Bluetooth® technology are not available in all countries.
For more information, please contact the official local Festool import partner.
You can find the overview regarding our products and our partners worldwide on our website www.festool.com

PU = Packaging Units
SU = Shipping Units



¹⁾ Manufacturer's recommended retail price.
Dealer prices may vary.

Systainer and transport systems







Denomination and application

Order no. PU Trade price
€ excl. VAT SU DG
per PU ¹⁾

Systainer³ XXL

	Dimensions with adjustable legs (L x W x H) mm	Inner dimensions (L x W x H) mm	Volume l	Load capacity kg	Load capacity (connected) kg					
 SYS3 XXL 237 incl. cover for label field	792 x 296 x 237	786 x 279 x 188	42,3	40	80	204850	1	95,60	1	214001
 SYS3 XXL 337 incl. cover for label field	792 x 296 x 337	786 x 279 x 288	64,2	40	80	204851	1	103,90	1	214001

Systainer T-LOC without inserts







	Dimensions (L x W x H) mm	Dimensions with adjustable legs (L x W x H) mm	Inner dimensions (L x W x H) mm	Product weight kg						
 SYS 1 TL incl. cover for label field in carton	396 x 296 x 105	396 x 296 x 112	383 x 273 x 75	1,3	497563	1	58,20	1	214001	
 SYS 2 TL incl. cover for label field in carton	396 x 296 x 157,5	396 x 296 x 164,5	383 x 267 x 127,5	1,5	497564	1	63,30	1	214001	
 SYS 3 TL incl. cover for label field in carton	396 x 296 x 210	396 x 296 x 217	382 x 266 x 180	1,8	497565	1	68,50	1	214001	
 SYS 4 TL incl. cover for label field in carton	396 x 296 x 315	396 x 296 x 322	382 x 266 x 285	2,1	497566	1	73,80	1	214001	
 SYS 5 TL incl. cover for label field in carton	396 x 296 x 420	396 x 296 x 427	381 x 265 x 384	2,7	497567	1	78,80	1	214001	
 Box TZE-SYS 1 TL for SYS 1 T-LOC box; insert for fixing and positioning boxes; plastic containers are not included in the scope of delivery	-	-	-	-	498043	1	7,80	1	214003	

* Attention: Festool products with Bluetooth® technology are not available in all countries.
For more information, please contact the official local Festool import partner.
You can find the overview regarding our products and our partners worldwide on our website www.festool.com

PU = Packaging Units
SU = Shipping Units

¹⁾ Manufacturer's recommended retail price.
Dealer prices may vary.

Systainer and transport systems

Denomination and application	Order no.	PU	Trade price		SU	DG			
			€ excl. VAT	per PU ¹⁾					
 <p>Box 49x49/12 SYS1 TL for SYS 1 T-LOC box; red; boxes excl. content; for clear storage and organisation</p>	49 x 49 x 71	-	-	-	498038	12	14,00	1	214003
 <p>Box 49x98/6 SYS1 TL for SYS 1 T-LOC box; yellow; boxes excl. content; for clear storage and organisation</p>	49 x 98 x 71	-	-	-	498039	6	10,70	1	214003
 <p>Box 98x98/3 SYS1 TL for SYS 1 T-LOC box; blue; boxes excl. content; for clear storage and organisation</p>	98 x 98 x 71	-	-	-	498040	3	9,00	1	214003
 <p>Box 98x147/2 SYS1 TL for SYS 1 T-LOC box; green; boxes excl. content; for clear storage and organisation</p>	98 x 147 x 71	-	-	-	498041	2	11,60	1	214003
 <p>Box 49x245/2 SYS1 TL for SYS 1 T-LOC box; orange; boxes excl. content; for clear storage and organisation</p>	49 x 245 x 71	-	-	-	498042	2	11,80	1	214003
 <p>Set 60x60/120x71 3xFT for SYS-COMBI 2, SYS-COMBI 3 and SYS 4 TL-SORT/3; plastic containers and compartment dividers for individual drawer partitions; 8 x box of plastic containers 60 x 60 x 71 mm, 4 x box of plastic containers 60 x 120 x 71 mm, 3 x compartment dividers, 2 x cover pads</p>	-	-	-	-	201124	1	21,40	1	214003

MAXI-Systainer T-LOC

	Dimensions (L x W x H) mm	Inner dimensions (L x W x H) mm	Product weight kg					
 <p>SYS MAXI can be connected with Systainer³ M, T-LOC, SORTAINER in carton</p>	596 x 390 x 210	545 x 330 x 168	4	490701	1	101,10	1	214001
<p>SYS MAXI 2 can be connected with Systainer³ M, T-LOC, SORTAINER in carton</p>	596 x 390 x 157,5	545 x 330 x 124	3	492582	1	92,20	1	214001

* Attention: Festool products with Bluetooth® technology are not available in all countries.
For more information, please contact the official local Festool import partner.
You can find the overview regarding our products and our partners worldwide on our website www.festool.com

PU = Packaging Units
SU = Shipping Units







¹⁾ Manufacturer's recommended retail price.
Dealer prices may vary.

Systainer and transport systems

Denomination and application

Order no. PU Trade price
€ excl. VAT SU DG
per PU ¹⁾

MINI-Systainer T-LOC



	Dimensions (L x W x H) mm	Inner dimensions (L x W x H) mm	Product weight kg					
 <p>SYS-MINI 1 TL for clear and structured arrangement of small parts and hand-held tools; can be combined with SYS-MINI 1 and 3 TL; cannot be connected to Systainer³, Systainer T-LOC or Systainer classic</p>	265 x 171 x 71	255 x 155 x 53	0,4	499622	1	18,50	1	214001
 <p>SYS-MINI 1 TL TRA for clear and structured arrangement of small parts and hand-held tools; can be combined with SYS-MINI 1 and 3 TL; cannot be connected to Systainer³, Systainer T-LOC or Systainer classic; transparent cover</p>	265 x 171 x 71	255 x 155 x 53	0,4	203813	1	22,40	1	214001
 <p>SYS-MINI 1 TL TRA UNI for clear and structured arrangement of small parts and hand-held tools; can be combined with SYS-MINI 1 and 3 TL; cannot be connected to Systainer³, Systainer T-LOC or Systainer classic; TZE-UNI SYS MINI TL multi-purpose insert (499620), transparent cover</p>	265 x 171 x 71	255 x 155 x 53	0,6	203821	1	37,70	1	214001
 <p>SYS-MINI 3 TL for clear and structured arrangement of small parts and hand-held tools; can be combined with SYS-MINI 1 and 3 TL; cannot be connected to Systainer³, Systainer T-LOC or Systainer classic</p>	265 x 171 x 142	255 x 155 x 124	0,6	202544	1	24,40	1	214001
 <p>SE-DP SYS-MINI TL for SYS MINI TL</p>	247 x 134 x 15	-	-	499619	1	6,60	1	214003
 <p>TZE-UNI SYS MINI TL for SYS MINI TL</p>	258 x 163 x 45	-	-	499620	1	8,90	1	214003



* Attention: Festool products with Bluetooth® technology are not available in all countries.
For more information, please contact the official local Festool import partner.
You can find the overview regarding our products and our partners worldwide on our website www.festool.com

PU = Packaging Units
SU = Shipping Units

¹⁾ Manufacturer's recommended retail price.
Dealer prices may vary.

Systainer and transport systems

Denomination and application	Order no.	PU	Trade price			SU	DG				
			€ excl. VAT	per PU ¹⁾							
Systainer T-LOC with lid compartment											
 <p>SYS 1 TL-DF incl. cover for label field</p>			Dimensions (L x W x H) mm 396 x 296 x 105	Dimensions with adjustable legs (L x W x H) mm 296 x 296 x 112	Inner dimensions (L x W x H) mm 273 x 273 x 68	Product weight kg 1,5	497851	1	70,50	1	214001
 <p>SYS 2 TL-DF incl. cover for label field</p>			396 x 296 x 157,5	396 x 296 x 164,5	383 x 267 x 121	1,7	497852	1	75,70	1	214001
 <p>SYS 3 TL-DF incl. cover for label field</p>			396 x 296 x 210	396 x 296 x 217	382 x 266 x 173	2	498390	1	79,50	1	214001

Systainer T-LOC SYS-Combi												
			Dimensions (L x W x H) mm	Dimensions with adjustable legs (L x W x H) mm	Internal dimensions of the top compartment (L x W x H) mm	Internal dimensions of the drawer (L x W x H) mm	Product weight kg					
 <p>SYS-COMBI 2 combination of the Systainer T-LOC size 2 and a spacious drawer; flexibly divisible drawer for accessories, consumables, small parts and sundries</p>			396 x 296 x 263	396 x 296 x 270	383 x 267 x 127	350 x 255 x 69	3,2	200117	1	112,50	1	214013
 <p>SYS-COMBI 3 flexibly divisible drawer for accessories, consumables, small parts and sundries; combination of the Systainer T-LOC size 3 and a spacious drawer</p>			396 x 296 x 315	396 x 296 x 322	382 x 266 x 180	350 x 255 x 69	3,5	200118	1	120,90	1	214013
 <p>Set 60x60/120x71 3xFT for SYS-COMBI 2, SYS-COMBI 3 and SYS 4 TL-SORT/3; plastic containers and compartment dividers for individual drawer partitions; 8 x box of plastic containers 60 x 60 x 71 mm, 4 x box of plastic containers 60 x 120 x 71 mm, 3 x compartment dividers, 2 x cover pads</p>			-	-	-	-	-	201124	1	21,40	1	214003

* Attention: Festool products with Bluetooth® technology are not available in all countries. For more information, please contact the official local Festool import partner. You can find the overview regarding our products and our partners worldwide on our website www.festool.com

PU = Packaging Units
SU = Shipping Units





¹⁾ Manufacturer's recommended retail price. Dealer prices may vary.

Systainer and transport systems



Denomination and application

Order no. PU Trade price
€ excl. VAT SU DG
per PU ¹⁾

SORTAINER

	Dimensions (L x W x H) mm	Product weight kg					
 <p>SYS 4 TL-SORT/3 three drawers, each with a capacity of 6.7 litres, can be set up and divided individually with plastic containers and partitions (plastic containers and small partitions are not included); compatible and can be connected to all Systainer generations, mobile dust extractors and many other system accessories</p>	396 x 296 x 322	5,95	200119	1	124,30	1	214002
 <p>SYS 3-SORT/4 2 x small drawer (L x W x D) 255 x 75 x 30 mm, medium drawer (L x W x D) 255 x 165 x 30 mm, large drawer (L x W x D) 255 x 348 x 85 mm, 2 dividers per drawer, 6 x label holders, 8 x lettering strips</p>	395 x 295 x 210	4	491522	1	138,80	1	214002
 <p>SYS 3-SORT/6 6 x medium drawer (L x W x D) 255 x 165 x 30 mm, 2 dividers per drawer, 6 x label holders, 8 x lettering strips</p>	395 x 295 x 210	4,9	491984	1	154,50	1	214002
 <p>SYS 3-SORT/9 6 x small drawer (L x W x D) 255 x 75 x 30 mm, 3 x medium drawer (L x W x D) 255 x 165 x 30 mm, 2 dividers per drawer, 9 x label holders, 16 x lettering strips</p>	395 x 295 x 210	5,1	491985	1	154,50	1	214002
 <p>SYS 3-SORT/12 12 x small drawer (L x W x D) 255 x 75 x 30 mm, 2 dividers per drawer, 12 x label holders, 16 x lettering strips</p>	395 x 295 x 210	5,3	491986	1	154,50	1	214002

Systainer³ ToolBox



	Contact surface mm	Height mm	Load capa- city kg	Volume l	Dimensions (L x W x H) mm					
 <p>SYS-TB-2 for practical transportation of hand tools, consumable materials and accessories</p>	396 x 296	257	14	20	396 x 296 x 257	499550	1	54,80	1	214009
 <p>SYS3 TB M 137 for practical transportation of hand tools, consumable materials and accessories; incl. cover for label field</p>	-	-	-	10,4	-	204865	1	49,80	1	214009

* Attention: Festool products with Bluetooth® technology are not available in all countries.
For more information, please contact the official local Festool import partner.
You can find the overview regarding our products and our partners worldwide on our website www.festool.com





PU = Packaging Units
SU = Shipping Units

¹⁾ Manufacturer's recommended retail price.
Dealer prices may vary.

Systainer and transport systems

Denomination and application						Order no.	PU	Trade price € excl. VAT	SU	DG
						per PU ¹⁾				
	Contact surface mm	Height mm	Load capacity kg	Volume l	Dimensions (L x W x H) mm					
	-	-	-	21,4	-	204866	1	56,60	1	214009
SYS3 TB M 237 for practical transportation of hand tools, consumable materials and accessories; incl. cover for label field										
	-	-	-	13,2	-	204867	1	60,30	1	214009
SYS3 TB L 137 with a broader base area for even more space; for practical transportation of hand tools, consumable materials and accessories; incl. cover for label field										
	-	-	-	27,4	-	204868	1	68,90	1	214009
SYS3 TB L 237 with a broader base area for even more space; for practical transportation of hand tools, consumable materials and accessories; incl. cover for label field										

SYS-StorageBox

	Dimensions (L x W x H) mm	Height including handle mm	Product weight kg					
	396 x 296 x 167	240	2,5	499901	1	101,10	1	214010
SYS-SB plastic container, no content; with individually removable plastic containers; can be connected to the entire Systainer range (except SYS-Mini); 2 x box 60 x 60 x 71 mm SYS-SB; 2 x box 60 x 120 x 71 mm SYS-SB; 1 x box 180 x 120 x 71 mm SYS-SB								
	60 x 60 x 71	-	-	500066	6	11,20	1	214010
Box 60x60x71/6 SYS-SB for SYS-Storage Box SYS-SB								
	60 x 120 x 71	-	-	500067	4	12,90	1	214010
Box 60x120x71/4 SYS-SB for SYS-Storage Box SYS-SB								
	180 x 120 x 71	-	-	500068	2	14,30	1	214010
Box 180x120x71/2 SYS-SB for SYS-Storage Box SYS-SB								

* Attention: Festool products with Bluetooth® technology are not available in all countries.
For more information, please contact the official local Festool import partner.
You can find the overview regarding our products and our partners worldwide on our website www.festool.com

PU = Packaging Units
SU = Shipping Units

¹⁾ Manufacturer's recommended retail price.
Dealer prices may vary.

Systainer and transport systems

Denomination and application

Order no. PU Trade price
€ excl. VAT SU DG
per PU ¹⁾

Systainer SYS3-CE XXS



SYS3 XXS 33 GRY

made from sturdy ABS plastic; can be connected to other Systainer³ XXS; functional handle and T-LOC fastener; made in Germany

Inner dimensions (L x W x H) mm	Dimensions (L x W x H) mm	Order no.	PU	Trade price € excl. VAT per PU ¹⁾	SU	DG
59 x 102 x 23	66 x 105 x 31	205398	1	5,30	1	397003

Application Systainer

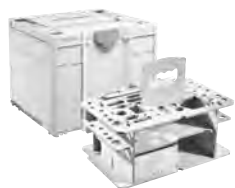

SYS3 HWZ M 337

with wooden insert for hand tools; items included without tools (equipment recommendation)



SYS-MFT

incl. cover for label field; can be connected to the entire Systainer range (except SYS-MINI); simple, compact transportation; cover with MDF board for clamping and fixing workpieces



SYS-PH

for connecting power tools, chargers, mobile dust extractors, working lights, etc.; also suitable for charging a smartphone while protecting it from contamination, for example, thanks to the internal socket; 4x external sockets; 1x internal socket; integrated thermal protection switch; 10 m connection cable, type H07 RN F3G1.5, securely connected; Systainer SYS 2 T-LOC (497564)

Dimensions (L x W x H) mm	Dimensions with adjustable legs (L x W x H) mm	Inner dimensions (L x W x H) mm	Product weight kg	Volume l	Order no.	PU	Trade price € excl. VAT per PU ¹⁾	SU	DG
-	396 x 296 x 337	389 x 275 x 296	4,4	32,4	205518	1	163,60	1	214001
396 x 296 x 105	396 x 296 x 112	383 x 273 x 75	2	-	500076	1	73,00	1	214001
396 x 296 x 157,5	-	383 x 154 x 128	4,2	-	200231	1	174,70	1	214012

Systainer with inserts for abrasives



SYS-STF D125

with insert for abrasives Ø 125 mm







SYS-STF D 150 4S

with insert for abrasives Ø 150 mm; for grits P80, P180, P280, P400 and P500 according to the Festool "4-step sanding" system

Dimensions (L x W x H) mm	Inner dimensions (L x W x H) mm	SYSTAINER size	Number of compartments	Order no.	PU	Trade price € excl. VAT per PU ¹⁾	SU	DG
396 x 296 x 105	-	SYS 1 T-LOC	5	497685	1	62,60	1	214001
396 x 296 x 237	-	SYS3 M 237	10	576843	1	78,30	1	214001

Systainer and transport systems

Denomination and application					Order no.	PU	Trade price € excl. VAT	SU	DG
					per PU ¹⁾				
	Dimensions (L x W x H) mm	Inner dimensions (L x W x H) mm	SYSTAINER size	Number of compart- ments					
 SYS-STF-80x133/D125/Delta with insert for abrasives measuring 80 x 133 mm with dia. 125 mm and Delta	396 x 296 x 112	-	SYS3 M 112	5	576781	1	63,00	1	214001
 SYS-STF-D77/D90/93V with insert for abrasives with dia. 77 mm, dia. 90 mm and V93	396 x 296 x 112	-	SYS3 M 112	8	576784	1	62,20	1	214001
 SYS-STF D150 with insert for abrasives Ø 150 mm	396 x 296 x 237	-	SYS3 M 237	10	576785	1	73,70	1	214001
 SYS-STF-D225 for long-reach sander PLANEX LHS 2 225 EQ(I); with insert for abrasive, dia. 225 mm	396 x 296 x 337	-	SYS3 M 337	5	576786	1	78,20	1	214001
 SYS3-OF D8/D12 with foam insert; for safe storage of cutters D 8, D 12	396 x 296 x 112	389 x 275 x 71	SYS3 M 112	-	576835	1	82,10	1	214001

Systainer with insert for battery and charging technology



	Number of compartments (battery packs)	Number of compartments (charger)	SYSTAINER size	Dimensions with adjustable legs (L x W x H) mm	Product weight kg					
 SYS3 M 187 ENG 18V suitable for the BP 18 Li battery packs and the TCL 6, TCL 6 DUO and SCA 8 chargers; not suitable for the Ergo battery packs (ETSC, DTSC, RTSC); for practical and tidy storage and transport of up to four 18 V battery packs (excluding Ergo battery pack) and two Li-ion rapid chargers (TCL 6, SCA 8)	4	2	SYS3 M 187	396 x 296 x 187	1,8	577133	1	73,70	1	214001

* Attention: Festool products with Bluetooth® technology are not available in all countries.
For more information, please contact the official local Festool import partner.
You can find the overview regarding our products and our partners worldwide on our website www.festool.com

PU = Packaging Units
SU = Shipping Units

¹⁾ Manufacturer's recommended retail price.
Dealer prices may vary.

Systainer and transport systems

Denomination and application		Order no.	PU	Trade price € excl. VAT per PU ¹⁾	SU	DG
Means of transport for Systainer						
	Roll board, SYS-RB for easy transportation of Systainer ³ and T-LOC; 4 robust handles; 4 steering rollers, (2 of which can be locked); feedthroughs for straps bASE 508 x 396 mm; load capacity 100 kg; roll dia. 100 mm; Product weight 2,9 kg	204869	1	87,40	1	214004
	SYS-Roll, SYS-Roll 100 for transporting Systainer ³ , T-LOC and Classic; extra large wheels (D 200 mm) for easy transportation up and down steps; rotating lockable front rollers - manoeuvre in all directions; incl. safety belt total load capacity 100 kg; drawer load capacity 5 kg; front roll dia. 75 mm; rear roll dia. 200 mm; Product weight 6,5 kg	498660	1	185,90	1	214004
Systainer-Port						
	Systainer-Port, SYS-PORT 500/2 the height of the individual pull-out drawers can be adjusted – for flexible equipping with different Systainer and SORTAINER sizes; no admission for assembly in car; without Systainer; stable full metal body, 5 x labels for drawers, with 3 Systainer telescopic drawers dimensions (L x W x H) 400 x 500 x 500 mm; Product weight 19 kg	491921	1	461,40	1	214005
	Systainer-Port, SYS-PORT 1000/2 the height of the individual pull-out drawers can be adjusted – for flexible equipping with different Systainer and SORTAINER sizes; no admission for assembly in car; without Systainer; stable full metal body, 5 x labels for drawers, with 5 Systainer telescopic drawers, 4 ball bearing-mounted swivel castors (2 with locking brakes) dimensions (L x W x H) 400 x 500 x 1100 mm; Product weight 33 kg	491922	1	620,60	1	214005
	Set of castors, SYS-PORT R/2 for SYS port; for assembly on SYS-Port diameter 75 mm	491932	1	82,20	1	214005
	Telescopic drawer, SYS-PORT/TA	491923	1	114,30	1	214005
Systainer pull-out drawer						
	Pull-out drawer, SYS-AZ for Systainer ³ M, T-LOC and Classic; for constructing an individual shelf system; in 32 hole grid max. load 20 kg; dimensions (L x W x H) 425 x 376 x 57 mm	500692	1	43,40	1	214011
	Pull-out drawer, SYS-AZ-Set for Systainer ³ M, T-LOC and Classic; for constructing an individual shelf system; in 32 hole grid max. load 20 kg; dimensions (L x W x H) 425 x 376 x 57 mm	500767	5	216,80	1	214011
	Lock, S-AZ for SYS-AZ; simultaneous lock; for subsequent installation in the pull-out drawer SYS-AZ; locks the individual pull-out drawer on the side of the body (simultaneous)	500693	1	12,80	1	214011

* Attention: Festool products with Bluetooth® technology are not available in all countries.
 For more information, please contact the official local Festool import partner.
 You can find the overview regarding our products and our partners worldwide on our website www.festool.com

PU = Packaging Units
 SU = Shipping Units

¹⁾ Manufacturer's recommended retail price.
 Dealer prices may vary.

Systainer and transport systems

Denomination and application	Order no.	PU	Trade price		
			€ excl. VAT	SU	DG
 <p>Other accessories Cover, AB-BF SYS TL 55x85mm /10 transparent cover for the labelling panels of Systainer³, Systainer³ Organizer and T-LOC; protects the labelling from damage and moisture</p>	497855	10	5,10	1	214003

Accessories for Systainer



Foam inserts for Systainer					
 <p>SE-VAR SYS3 M/2 for Systainer³ M; diced sections can be pushed out to produce any desired aperture</p>	204942	2	17,90	1	214003
 <p>SE-VAR SYS3 L/2 for Systainer³ L; diced sections can be pushed out to produce any desired aperture</p>	204946	2	39,50	1	214003
 <p>SE-VAR SYS3 M/2 for Systainer³ M; diced sections can be pushed out to produce any desired aperture</p>	204942	2	17,90	1	214003
 <p>SE-VAR SYS3 L/2 for Systainer³ L; diced sections can be pushed out to produce any desired aperture</p>	204946	2	39,50	1	214003
Lids and bottoms for Systainers					
 <p>Cover pad, SE-DP SYS3 M for Systainer³ M; protects the content</p>	204940	1	6,60	1	214003
 <p>Base pad, SE-BP SYS3 M for Systainer³ M; protects the content</p>	204941	1	7,30	1	214003
 <p>Cover pad, SE-DP SYS3 L for Systainer³ L; protects the content</p>	204944	1	15,60	1	214003
 <p>Base pad, SE-BP SYS3 L for Systainer³ L; protects the content</p>	204945	1	13,40	1	214003

* Attention: Festool products with Bluetooth® technology are not available in all countries.
 For more information, please contact the official local Festool import partner.
 You can find the overview regarding our products and our partners worldwide on our website www.festool.com

PU = Packaging Units
 SU = Shipping Units

¹⁾ Manufacturer's recommended retail price.
 Dealer prices may vary.

Systainer and transport systems

Denomination and application		Order no.	PU	Trade price € excl. VAT per PU ¹⁾	SU	DG
	Cover pad, SE-DP SYS3 XXL for Systainer ³ XXL; protects the content	204947	1	32,90	1	214003
	Base pad, SE-BP SYS3 XXL for Systainer ³ XXL; protects the content	204948	1	36,60	1	214003
Other accessories for the Systainer						
	Cartridge inlay, TZE-KT SYS3 M for Systainer ³ M 337/437; for storage of cartridges and cartridge caps	204943	1	22,30	1	214003

* Attention: Festool products with Bluetooth® technology are not available in all countries.
For more information, please contact the official local Festool import partner.
You can find the overview regarding our products and our partners worldwide on our website www.festool.com

PU = Packaging Units
SU = Shipping Units

¹⁾ Manufacturer's recommended retail price.
Dealer prices may vary.

Denomination and application	Order no.	PU	Trade price		
			€ excl. VAT	SU	DG

Construction site radios and Bluetooth® speakers

SYSROCK construction site radio					
	Digital radio SYSROCK, BR 10 DAB+ operation with Festool 18 V battery packs (with the exception of Ergo battery packs) or power cable; Receives analogue (FM) and digital (DAB+) stations; USB interface for charging external devices; 230 V adapter, aux-in cable, bag	202111	1	193,00	115005
	Site radio SYSROCK, BR 10 FM radio with Bluetooth® and AUX-IN interface; operation with Festool 18 V battery packs (with the exception of Ergo battery packs) or power cable; 230 V adapter, aux-in cable, bag	200183	1	155,00	115005

Bluetooth® TOPROCK speaker					
	Bluetooth® speaker, SYS3 BT20 M 137 230 V adapter speaker 20 W; Number of speakers 4; Bluetooth® standard V5; max. Bluetooth® range 50 m; integrated battery 11 V	205502	1	219,00	115005

Mobile workshop

Mobile workshop					
	Mobile workshop, MW 1000 Basic SYS-AZ-MW 1000 pull-out drawer [203456] work height 900 mm; dimensions [L x W x H] 641 x 600 x 1076 mm; table dimensions 445 x 363 mm; total load capacity 100 kg; drawer load capacity 20 kg	203454	1	503,50	205012
	Mobile workshop, MW 1000 SYS-AZ-MW 1000 pull-out drawer [203456], TSB/1-MW 1000 table [203457] work height 900 mm; dimensions [L x W x H] 641 x 600 x 1185 mm; table dimensions 445 x 363 mm; extension table dimensions 1045 x 500 mm; total load capacity 100 kg	203802	1	793,50	205012

Accessories for mobile workshop					
	Pull-out drawer, SYS-AZ-MW 1000 for MW 1000 mobile workshop; tool-free attachment and customised height adjustment dimensions [L x W x H] 493 x 373 x 118 mm; drawer load capacity 20 kg; Product weight 3,2 kg	203456	1	71,30	205005
	Pull-out drawer, SYS-AZ for Systainer ³ M, T-LOC and Classic; for constructing an individual shelf system; in 32 hole grid max. load 20 kg; dimensions [L x W x H] 425 x 376 x 57 mm	500692	1	43,40	214011

* Attention: Festool products with Bluetooth® technology are not available in all countries.
For more information, please contact the official local Festool import partner.
You can find the overview regarding our products and our partners worldwide on our website www.festool.com

PU = Packaging Units
SU = Shipping Units

¹⁾ Manufacturer's recommended retail price.
Dealer prices may vary.







Workplace organisation

Denomination and application		Order no.	PU	Trade price € excl. VAT per PU ¹⁾	SU	DG
	Base, TSB/1-MW 1000 for MW 1000 mobile workshop and MFT 3; extended work space; aluminium profile and perforated top allow for use of many existing accessories work height 900 mm; dimensions [L x W x H] 1045 x 500 x 74 mm; Product weight 12,2 kg	203457	1	290,00	1	205005
	Additional clamp, MFT/3-ZK for securing the stop rail to the V-groove	495541	1	36,90	1	205005
	Fixed clamps, MFT-SP for MFT; for safe and precise securing of the workpiece (sawing, sanding, routing, drilling, etc.)	488030	2	101,80	1	205005
	Lever clamp, MFT-HZ 80 for MW 1000 mobile workshop and MFT 3; It is possible to secure different materials up to a height of 80 mm dimensions [L x W x H] 130 x 40 x 155 mm; maximum height of workpiece 80 mm	577132	1	41,10	1	205005
	Lever clamp, FS-HZ 160 for FS/2, MFT; solid steel version clamping width 160 mm	491594	1	55,80	1	213002
	Fastening clamp, FSZ 120 for FS/2, MFT; solid steel version clamping width 120 mm	489570	2	40,60	1	213002
	Fastening clamp, FSZ 300 for FS/2, MFT; solid steel version clamping width 300 mm	489571	2	50,00	1	213002

Universalcenter and sets

Universalcenter		Order no.	PU	Trade price € excl. VAT per PU ¹⁾	SU	DG
	Universalcenter, UCR 1000 mobile and compact work station for work without dust extraction; WCR 1000 Workcenter (497471), multifunction stool MFH 1000 (without seat cushion)	498966	1	762,40	1	215007

Workplace organisation





Denomination and application		Order no.	PU	Trade price € excl. VAT per PU ¹⁾	SU	DG
Workcenter						
	Workcenter Workcenter, WCR 1000 not compatible with high-pressure mobile dust extractors; Storage shelf, storage trough, storage base for pegboard (497477), double tool hook (497474), 6 x standard hooks (125 mm long) (497475), 2 x pegboards with square holes, Systainer retainer	497471	1	437,70	1	215007
Multifunction stool						
	Multifunction stool Multifunction stool, MFH 1000 mobile in the workshop; seat cushion MFH 1000 SK, Assembly set	498967	1	362,10	1	215008
Toolcenter						
	Toolcenter TC 3000/2 Toolcenter, TC 3000/2 mobile sanding station with large working and storage areas; lockable tool cabinet with intermediate shelf for storing Systainers and Sortainers, extractor dock with fastening clamp for the CT, CTL, CTM 22/26/33/36/48, SR 200 and SR 45 with lashing strap (accessory); hose holder (487304), anti-slip mat	583881	1	719,10	1	215006
Accessories for Workcenter, multifunction stool, Universalcenter, Toolcenter						
	Accessories for Workcenter, multifunction stool, Universalcenter, Toolcenter Feather key, WCR 1000 PF 2x for WCR 1000, UCR 1000; The keys enable the attachment of individual accessories to the profiled groove; 2x keys incl. bits	497476	1	13,70	1	215003
	Pegboard hook, LWH HSK-A for WCR 1000, MFH 1000, UCR 1000; for hanging hand sanding blocks HSK-A 80x130, HSK-A 80x200 and HSK-A 115x226; not suitable for hand sanding block HSK-A 80x400; the protective coating prevents damage dimensions length x width 38 x 38,1 mm	498968	1	36,30	1	215003
	Tool hook, WCR 1000 WH for WCR 1000, UCR 1000; for hanging two tools; for use as a hose holder	497474	1	62,70	1	215003
	Hook, WCR 1000 SHQ for WCR 1000, UCR 1000; Standard hooks for mounting on the pegboard	497475	6	23,40	1	215003

* Attention: Festool products with Bluetooth® technology are not available in all countries.
 For more information, please contact the official local Festool import partner.
 You can find the overview regarding our products and our partners worldwide on our website www.festool.com



PU = Packaging Units
 SU = Shipping Units

¹⁾ Manufacturer's recommended retail price.
 Dealer prices may vary.

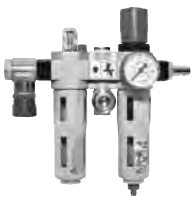

Workplace organisation

Denomination and application	Order no.	PU	Trade price € excl. VAT per PU ¹⁾	SU	DG
 <p>Holder for spray gun, WCR 1000 LPH for WCR 1000; holder for paint gun; for assembly at the profile groove for the WCR 1000 Workcenter; 2x screw, 2x square nut dimensions (L x W x H) 148 x 76 x 60 mm; Product weight 0,5 kg</p>	498361	1	29,00	1	215003
 <p>Storage surface, WCR 1000 AB for WCR 1000, UCR 1000; Large storage surface for placing sundries, boxes of abrasives or screws, etc.</p>	497477	1	47,90	1	215003
 <p>Rear wall, TC 3000 RW for Toolcenters TC 3000, TC 3000/2 incl. 10 hooks dimensions length x width 990 x 340 mm</p>	452986	1	177,10	1	215001
 <p>Tool holder, WHR/D-TC for the TC 2000, TC 3000, TC 3000/2; for safe, ergonomic storage of two electric and air tools at the same time</p>	493415	1	58,90	1	215001
 <p>Hose holder, TC-SH for the TC 2000, TC 3000, TC 3000/2; for retrofitting TC 3000</p>	487304	1	64,00	1	215001
 <p>Service unit, VE-TC 3000 for Toolcenter TC 2000, TC 3000; for compressed air supply to mobile dust extractors CT 22/33 and SR 151, SR 200 series dust extractors in LE design</p>	454808	1	487,20	1	215001

Multifunction table

 <p>Multifunction table MFT 3</p>					
<p>Multifunction table, MFT/3 table with perforated top and foldaway legs, swivel unit, support unit, angle stop, adjustable stop [495542], guide rail FS 1080/2 [491504], deflector FS-AW [489022], additional clamp [495541]</p>	495315	1	743,10	1	205010
 <p>Multifunction table, MFT/3 Basic table with perforated top and foldaway legs</p>	500608	1	583,90	1	205010

Workplace organisation

Denomination and application		Order no.	PU	Trade price € excl. VAT per PU ¹⁾	SU	DG
	Multifunction table, MFT KAPEX used as a base frame for the KAPEX; clamping kit SZ-KS required for fixing; table with perforated top and foldaway legs	495465	1	403,70	1	205010
	Multifunction table, MFT/3 Conturo-AP for KA 65; table with perforated top and foldaway legs; for using the edge bander CONTURO KA 65 as a bench-mounted machine; adapter plate AP-KA 65 (500175), cross brace QT-MFT/3 (495502)	500869	1	950,80	1	205010

Accessories for multifunction table





Accessories						
	Cross brace, MFT 3-QT for additional MFT 3 stability diameter 20 mm; length 675 mm	495502	2	99,30	1	205005
	Additional clamp, MFT/3-ZK for securing the stop rail to the V-groove	495541	1	36,90	1	205005
	Fixed clamps, MFT-SP for MFT; for safe and precise securing of the workpiece (sawing, sanding, routing, drilling, etc.)	488030	2	101,80	1	205005
	Lever clamp, MFT-HZ 80 for MW 1000 mobile workshop and MFT 3; it is possible to secure different materials up to a height of 80 mm dimensions (L x W x H) 130 x 40 x 155 mm; maximum height of workpiece 80 mm	577132	1	41,10	1	205005
	Lever clamp, FS-HZ 160 for FS/2, MFT; solid steel version clamping width 160 mm	491594	1	55,80	1	213002
	Fastening clamp, FSZ 120 for FS/2, MFT; solid steel version clamping width 120 mm	489570	2	40,60	1	213002

* Attention: Festool products with Bluetooth® technology are not available in all countries.
For more information, please contact the official local Festool import partner.
You can find the overview regarding our products and our partners worldwide on our website www.festool.com

PU = Packaging Units
SU = Shipping Units

¹⁾ Manufacturer's recommended retail price.
Dealer prices may vary.



Workplace organisation

Denomination and application		Order no.	PU	Trade price € excl. VAT per PU ¹⁾	SU	DG
	Fastening clamp, FSZ 300 for FS/2, MFT; solid steel version clamping width 300 mm	489571	2	50,00	1	213002
	Base, TSB/1-MW 1000 for MW 1000 mobile workshop and MFT 3; extended work space; aluminium profile and perforated top allow for use of many existing accessories work height 900 mm; dimensions (L x W x H) 1045 x 500 x 74 mm; Product weight 12,2 kg	203457	1	290,00	1	205005
	Connecting piece, VS for attachment of FST660/85 or MFT 800 to Basis Plus; for connecting several MFT 3	484455	1	14,80	1	205002
	Adapter, VAC SYS AD MFT 3 for VAC SYS SE 1, VAC SYS SE 2; for connecting the VAC SYS clamping unit with the MFT 3	494977	1	247,10	1	225001
	Adjustable stop, MFT/3-AR for the MFT 3; for securing workpieces on the angle stop; Can be folded away	495542	1	22,40	1	205005

STM 1800 work bench

	STM 1800 work bench Mobile saw table and work bench, STM 1800 height-adjustable work bench for machining large panels and cutting them to size; contact surface can be extended using extension tubes; castor wheels and wooden supports partially pre-installed (items included); fitted wooden coverings, four extension pipes with wooden coverings	205183	1	1.259,50	1	205014
--	--	--------	---	----------	---	--------

Accessories for STM 1800 work bench

	FS-WA angle stop Angle stop, FS-WA/90° for FS/2; for precise and reproducible 90° cutting of sheet materials without any readjustments; completely self-aligning and precise thanks to milled aluminium stop; easily and quickly connect with the guide rail using the quick-clamping lever	205229	1	141,80	1	213002
	Angle stop, FS-WA for FS/2; can be extended with FS-WA-VL guide extension; positioning bolt angular range -60 - +60 °	577040	1	156,10	1	213002
	Guide extension, FS-WA-VL for the FS-WA angle stop; used to extend the angle stop; cuts made to size with repeat accuracy using the guide extension with a scale and an adjustable stop; stable connection to the angle stop using the connecting pieces; adjustable stop, connecting pieces	577041	1	51,00	1	213002

Workplace organisation

Denomination and application	Order no.	PU	Trade price € excl. VAT per PU ¹⁾	SU	DG
------------------------------	-----------	----	--	----	----



Guide-rails

Guide rails of up to 5000 mm					
	Length mm				
	800	491499	1	65,60	213001
	FS 1080/2	491504	1	82,90	213001
	FS 1400/2	491498	1	98,00	213001
	FS 1900/2	491503	1	168,20	213001
	FS 2400/2	491502	1	241,40	213001
	FS 2700/2	491937	1	280,90	213001
	FS 3000/2	491501	1	301,60	213001
	FS 5000/2	491500	1	496,60	213001

Guide rails with adhesive pads					
	Length mm				
	1400	577043	1	119,60	213001
	FS 1900/2-KP FS-KP/30 adhesive pad [577042]	577044	1	187,20	213001

Guide rails with rows of holes					
	Length mm				
	1400	496939	1	120,30	206003
	FS 2424/2-LR 32	491622	1	293,00	206003

Accessories for guide rails

FS-WA angle stop					
	Angle stop, FS-WA/90° for FS/2; for precise and reproducible 90° cutting of sheet materials without any readjustments; completely self-aligning and precise thanks to milled aluminium stop; easily and quickly connect with the guide rail using the quick-clamping lever	205229	1	141,80	213002
	Angle stop, FS-WA for FS/2; can be extended with FS-WA-VL guide extension; positioning bolt angular range -60 - +60 °	577040	1	156,10	213002
	Guide extension, FS-WA-VL for the FS-WA angle stop; used to extend the angle stop; cuts made to size with repeat accuracy using the guide extension with a scale and an adjustable stop; stable connection to the angle stop using the connecting pieces; adjustable stop, connecting pieces	577041	1	51,00	213002

* Attention: Festool products with Bluetooth® technology are not available in all countries.
For more information, please contact the official local Festool import partner.
You can find the overview regarding our products and our partners worldwide on our website www.festool.com

PU = Packaging Units
SU = Shipping Units

¹⁾ Manufacturer's recommended retail price.
Dealer prices may vary.

Workplace organisation

Denomination and application	Order no.	PU	Trade price € excl. VAT per PU ¹⁾	SU	DG
FS-RAPID					
 <p>Quick-action clamp, FS-RAPID/R for clamping and positioning guide rails FS, FS/2 and GRP/2; Clamping jaws, fixed jaws</p>	489790	1	48,40	1	213002
 <p>Quick-action clamp, FS-RAPID/L for use of SSU 200, IS 330 with guide rail; for clamping and positioning with Festool guide rails; Clamping jaws, fixed jaws</p>	768116	1	48,40	1	213002
Accessories for guide rails					
 <p>Lever clamp, FS-HZ 160 for FS/2, MFT; solid steel version clamping width 160 mm</p>	491594	1	55,80	1	213002
 <p>Fastening clamp, FSZ 120 for FS/2, MFT; solid steel version clamping width 120 mm</p>	489570	2	40,60	1	213002
 <p>Fastening clamp, FSZ 300 for FS/2, MFT; solid steel version clamping width 300 mm</p>	489571	2	50,00	1	213002
 <p>Connecting piece, FSV/2 for FS/2; with a self-aligning function for connecting two guide rails for long workpieces so that the rails are straight; SW 5/SW 3 combination hex key</p>	577039	2	47,90	1	213002
 <p>Connecting piece, FSV to connect guide rails for long workpieces; qty. in pack: 1</p>	482107	1	17,10	1	213002
 <p>Deflector, FS/2-AW for FS/2; prevents the suction hose and the cable getting caught on the end of the guide rail</p>	204787	1	21,30	1	213002
 <p>Deflector, FS-AW prevents the suction hose and the cable getting caught on the end of the guide rail</p>	489022	1	21,10	1	213002

* Attention: Festool products with Bluetooth® technology are not available in all countries.
For more information, please contact the official local Festool import partner.
You can find the overview regarding our products and our partners worldwide on our website www.festool.com

PU = Packaging Units
SU = Shipping Units

¹⁾ Manufacturer's recommended retail price.
Dealer prices may vary.

Workplace organisation

Denomination and application	Order no.	PU	Trade price € excl. VAT per PU ¹⁾	SU	DG
 <p>Kickback stop, FS-RSP for TS 55, TS 55 R, TS 55 F, TSC 55, TSC 55 K, TS 75, HKC 55, HK 55, ATF 55, AP 55, AT 65, AP 65, AP 85; can also be used as guide stop; used as a rear and front stop position on guide rail FS/2</p>	491582	1	17,40	1	202001
 <p>Accessories set, SYS3 M 137 FS/2-Set for FS/2; FS-WA angle stop (577040), 2 FSV/2 connecting pieces (577039), FS/2-AW deflector (204787), FSZ 120 fastening clamps (two units) (489570), set-back stop FS-RSP (491582), SW 5/SW 3 combination hex key, Systainer SYS3 M 137 (204841)</p>	577157	1	223,70	1	213004
 <p>Accessories set, FS-SYS/2 FSZ 120 fastening clamps (two units) (489570), deflector FS-AW (489022), combination angle FS-KS (491588), set-back stop FS-RSP (491582), 2 connecting elements FSV (482107), splinter guard FS-SP 1400 (495207), Systainer SYS 1 T-LOC (497563)</p>	497657	1	177,90	1	213004
 <p>Adhesive pad, FS-KP/30 for FS/2-KP; secure grip for the FS/2-KP on a range of surfaces</p>	577042	30	20,80	1	413001
 <p>Combination bevel, FS-KS for FS/2; for angle cuts on guide rail between 0 and 180</p>	491588	1	98,40	1	213004
 <p>Angle stop, FS-AG-2 for FS/2 and GRP/2; for straight angle cuts for use with the guide rail</p>	768168	1	132,30	1	202001
 <p>Bag, FS-BAG carrying bag with shoulder straps; up to length of FS 1400/2</p>	466357	1	72,80	1	202001
 <p>Dual suction pad, GECKO DOSH-Set for carrying components or to fix the guide rail; for planer surfaces; adapter DOSH-FSAD (492616), dual suction pad GECKO DOSH (492617) load capacity 50 kg</p>	493507	1	90,90	1	297002
 <p>Dual suction pad, GECKO DOSH for carrying components or to fix the guide rail; for planer surfaces load capacity 50 kg</p>	492617	1	68,90	1	297002

* Attention: Festool products with Bluetooth® technology are not available in all countries.
For more information, please contact the official local Festool import partner.
You can find the overview regarding our products and our partners worldwide on our website www.festool.com



PU = Packaging Units
SU = Shipping Units

¹⁾ Manufacturer's recommended retail price.
Dealer prices may vary.

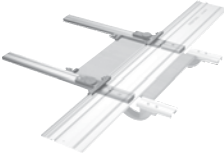
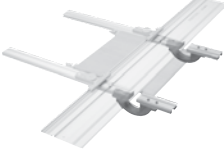
Workplace organisation

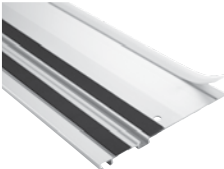
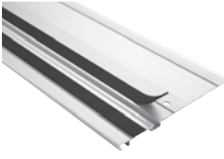
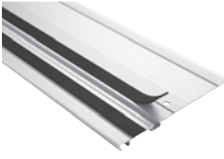
Denomination and application	Order no.	PU	Trade price € excl. VAT per PU ¹⁾	SU	DG
 <p>Adapter, DOSH-FSAD to fix the guide rail at the GECKO</p>	492616	1	22,30	1	297002
 <p>Parallel side fence, FS-PA for FS/2; for sawing along the width; for fixed cuts, can be re-set using the scale and end stop; mounting on the guide rail without the use of tools; stop ruler with additional clamp, adjustable stop max. workpiece width 650 mm</p>	495717	2	227,40	1	213004
 <p>Guide extension, FS-PA-VL for FS/2; only for use with the FS-PA; stop ruler, bridge, scale max. workpiece width 195 mm; max. material strength 70 mm</p>	495718	2	135,30	1	213004

Spare parts for guide rails					
 <p>Slideway lining, FS-GB 10M 10 m length; replacement slideway lining for FS/2 and FSK guide rails</p>	491741	1	36,50	1	413001
 <p>Splinter guard, FS-SP 1400/T replacement splinter guard for FS, FS/2 and FSK guide rails; transparent length 1400 mm</p>	495207	1	12,00	1	413001
 <p>Splinter guard, FS-SP 5000/T replacement splinter guard for FS, FS/2 and FSK guide rails; transparent length 5000 mm</p>	495209	1	28,90	1	413001
 <p>Adhesive cushion strip, FS-HU 10M 10 m roll, replacement adhesive cushion strip for FS, FS/2 and FSK guide rails</p>	485724	1	20,50	1	413001

Guide stops for routers					
 <p>guide rail adapter, FS-OF 1000 complete with support; for use of routers OF 900, OF 1000, OF 1010, OF 1010 R with the FS guidance system; without rods</p>	488752	1	38,60	1	206002
 <p>Guide rail adapter, FS-OF 1400 for OF 1400; with fine adjustment and support for router without guide rods; without rods</p>	492601	1	65,50	1	206002

* Attention: Festool products with Bluetooth® technology are not available in all countries.
For more information, please contact the official local Festool import partner.
You can find the overview regarding our products and our partners worldwide on our website www.festool.com

PU = Packaging Units
SU = Shipping Units

¹⁾ Manufacturer's recommended retail price.
Dealer prices may vary.

Workplace organisation

Denomination and application		Order no.	PU	Trade price € excl. VAT per PU ¹⁾	SU	DG
	Guide rail adapter, FS-OF 2200 for OF 2200; Without guide rods ST-OF 2200/2; With fine adjustment and support plate for router	494681	1	127,80	1	206002
	Hole drilling set, LR 32 Set for routers OF 900, OF 1000, OF 1010, OF 1400 in the FS-LR32 hole drilling system; for use with hole line guide rails; guide plate, centring mandrel, 2 x side stop, 2 x Longitudinal stop	583290	1	241,30	1	206003
	Guide plate, FP-LR 32 for routers OF 900, OF 1000, OF 1010, OF 1400 in the FS-LR32 hole drilling system; centring mandrel	494340	1	136,70	1	206003
	Parallel side fence, SA-LR 32 with adjustable stop; for parallel alignment of guide rails	485758	1	68,80	1	206003
	Stopper, LA-LR 32 FS positions the first hole on the hole series guide rail at a distance of 9.5, 16 or 32 mm from the workpiece edge	496938	2	42,40	1	206003
	Hole drilling set, LR 32-SYS for OF 900, OF 1000, OF 1010, OF 1400; for use with hole line guide rails; guide plate, centring mandrel, hinge location cutter HM Ø 35 mm, dowel drill HW Ø 5 mm (V-shaped tip), dowel drill HM Ø 5 mm (with centring bit and pre-cutter), 2 parallel side fences with adjustable stop, FSZ 120 fastening clamps (two units) [489570], 2 x Longitudinal stop, screwdriver, WAF 5, Systainer SYS 1 T-LOC (497563) Hole spacing 32 mm; Length of series of holes (without guide extension) 1400 / 2424; side stop setting range 0 - 110 mm; Product weight 0,9 kg	584100	1	472,50	1	206003
Guide stops for jigsaws						
	Guide rail adapter, FS-PS/PSB 300 for PS 200, PS 300, PSB 300, PS 2; allows use of jigsaws with FS and FS/2 guide systems	490031	1	15,80	1	203001
	base adapter, ADT-PS 420 for PS(C) 400/420, PSB(C) 400/420; for using the PS on the guide rail; for installation in the Compact Module System CMS; in conjunction with circle cutting attachment KS-PS 400	497303	1	16,00	1	203001

* Attention: Festool products with Bluetooth® technology are not available in all countries.
For more information, please contact the official local Festool import partner.
You can find the overview regarding our products and our partners worldwide on our website www.festool.com

PU = Packaging Units
SU = Shipping Units

¹⁾ Manufacturer's recommended retail price.
Dealer prices may vary.

Workplace organisation

Denomination and application

Order no. PU Trade price
€ excl. VAT SU DG
per PU ¹⁾

Trimming rails

Trimming rails

circular saws can be easily connected to the cross cutting guide rail to form a single unit, by means of a quick fastener; the compound mitre saw system makes work easier with fast, guided and precisely-angled cross cuts; for HKC 55, HK 55, HK 85



	Cutting length mm	Angular range °	Product weight kg					
FSK 250	250	-45 – +60	0,98	769941	1	152,40	1	213001
FSK 420	420	-60 – +60	1,26	769942	1	175,80	1	213001
FSK 670	670	-60 – +60	1,63	769943	1	199,20	1	213001

Accessories for trimming rails

Accessories for trimming rails



Bag, FSK420-BAG for FSK 250, FSK 420; transport bag with shoulder straps	200160	1	57,50	1	202001
Bag, FSK670-BAG for FSK 670; transport bag with shoulder straps	200161	1	69,20	1	202001

Other guide rails

AXT 50 LA saw guide







Saw guide, AUP 1750 special guide rail for AXT 50 LA length 1750 mm	482543	1	292,40	1	202002
Saw guide, AUP 3000 special guide rail for AXT 50 LA length 3000 mm	482544	1	475,40	1	202002

Workplace organisation

Denomination and application	Order no.	PU	Trade price € excl. VAT per PU ¹⁾	SU	DG
------------------------------	-----------	----	--	----	----

Vacuum clamping technology

Vacuum pump and clamping unit					
	Vacuum unit, VAC SYS SE 2 vacuum hose (495293), vacuum pad VAC SYS VT 275 x 100 mm (580066), connector	580062	1	573,00	1 125001
	Vacuum pump, VAC SYS VP	580060	1	700,00	1 125001
	Vacuum set, VAC SYS Set SE1 vacuum pump VAC SYS VP (580060), vacuum clamping unit VAC SYS SE1 (580061), vacuum hose (495293), foot valve (580063)	712223	1	1.273,00	1 125001
	Vacuum unit, VAC SYS SE 1 vacuum pad VAC SYS VT D 215 (580067) in carton	580061	1	573,00	1 125001

Accessories for vacuum pump and clamping unit



Accessories for vacuum pump and clamping unit					
	Foot valve, VAC SYS FV for the VAC SYS SE 1 or in a combination of the VAC SYS SE 1 with the VAC SYS SE 2; for releasing the vacuum pad	580063	1	95,50	1 225001
	Vacuum pad, VAC SYS VT 200 x 60 for VAC SYS SE 1, VAC SYS SE 2 pad dimensions 200 x 60 mm	580064	1	87,30	1 225001
	Vacuum pad, VAC SYS VT 277 x 32 for VAC SYS SE 1, VAC SYS SE 2 pad dimensions 277 x 32 mm	580065	1	130,00	1 225001
	Vacuum pad, VAC SYS VT 275 x 100 for VAC SYS SE 1, VAC SYS SE 2 pad dimensions 275 x 100 mm	580066	1	102,30	1 225001
	Vacuum pad, VAC SYS VT D 215 for VAC SYS SE 1, VAC SYS SE 2 diameter 215 mm	580067	1	102,30	1 225001

* Attention: Festool products with Bluetooth® technology are not available in all countries.
 For more information, please contact the official local Festool import partner.
 You can find the overview regarding our products and our partners worldwide on our website www.festool.com



PU = Packaging Units
 SU = Shipping Units

¹⁾ Manufacturer's recommended retail price.
 Dealer prices may vary.

Workplace organisation

Denomination and application	Order no.	PU	Trade price € excl. VAT per PU ¹⁾	SU	DG
 <p>Accessories Systainer, VAC SYS VT Sort for VAC SYS SE 1, VAC SYS SE 2; also provides space for the VAC SYS VT D 215; vacuum pad VAC SYS VT 200 x 60 mm (580064), vacuum pad VAC SYS VT 277 x 32 mm (580065), vacuum pad VAC SYS VT 275 x 100 mm (580066), SYS 3 TL Systainer (497565)</p>	495294	1	343,20	1	225001
 <p>Adapter, VAC SYS AD MFT 3 for VAC SYS SE 1, VAC SYS SE 2; for connecting the VAC SYS clamping unit with the MFT 3</p>	494977	1	247,10	1	225001
 <p>Vacuum hose, D 16 x 5m VAC SYS for VAC SYS Set SE 1, VAC SYS SE2; for guide extension length 5 m</p>	495293	1	95,50	1	225001

Accessories for exhaust turbines

Accessories for exhaust turbines					
 <p>Main filter, HF-TURBO for TURBO 3091, 4001, 7501</p>	492731	1	204,40	1	210001
 <p>Dust bag, STB-TURBO 10X for TURBO 3091, 4001, 7501; for extraction turbine Turbo 3091, 4001, 7501</p>	492730	1	30,80	1	410001
 <p>Main filter, HF-TURBOII 8WP/14WP for TURBOII-8WP/14WP; approved for dust class M; filtration of dust filter surface area 25000 cm²</p>	499902	1	175,40	1	210001
 <p>Main filter, HF-EX-TURBOII 8WP/14WP for TURBOII-8WP/14WP ATEX; approved for dust class M; filtration of dust; filtering dust in Zone 22 filter surface area 25000 cm²</p>	499903	1	238,40	1	210001
 <p>Disposable bag, ENS-TURBO II /5 for TURBOII-8WP/14WP and TURBOII-8WP/14WP ATEX; for dust-free disposal of hazardous dust filling volume 50 l</p>	499904	5	94,80	1	410001

* Attention: Festool products with Bluetooth® technology are not available in all countries.
For more information, please contact the official local Festool import partner.
You can find the overview regarding our products and our partners worldwide on our website www.festool.com

PU = Packaging Units
SU = Shipping Units

¹⁾ Manufacturer's recommended retail price.
Dealer prices may vary.

Workplace organisation

Denomination and application		Order no.	PU	Trade price € excl. VAT per PU ¹⁾	SU	DG
Boom arms and energy boxes						
	Energy box EAA Energy box, EAA EW/DW CT/SRM/M for CT/SRM; manual slide actuation; automatic energy box without compressed air tools but with pressure reducer; energy box with 3 x 230 V connections, compressed air supply unit with 3 compressed air connections (2 x oiled and 1 x not oiled), 2 x Abrasive paper holder (496044)	583821	1	1.788,00	1	110004
	Boom arm ASA 5000 Boom arm, ASA 5000 CT/SR for CT mobile dust extractors and SRM extractors; with cable duct; double-jointed arm with wall bracket, wall mounting components are not included					
		583867	1	2.893,00	1	110002
Boom arm ASA 6000 Boom arm, ASA 6000 CT/SR for CT mobile dust extractors and SRM extractors; with cable duct; double-jointed arm with wall bracket, wall mounting components are not included						
		583868	1	3.026,00	1	110002
Accessories for boom arms						
   	Wall mounting, EAA-W-EU for energy boxes (models starting in 2009); 4 m cable sets, 4 m compressed air hose, aluminium tube (350 mm) with connecting sleeve, installation set for energy boxes	495889	1	323,00	1	210004
	Energy box module, EAA CT 26/36/48 for CT 26/36/48; for connecting a CT mobile dust extractor with an energy box or boom arm	496143	1	69,40	1	209002
	Adapter, IAS-ZA for central extraction units, boom arms manufactured by Rupes, IVO and Herkules, and Rupes power boxes; rubber bushing for connection of IAS 2/IAS 3 air tools via an IAS 2/IAS 3 connection; exterior Ø 59/75 mm; interior Ø 49/57 mm	489222	1	65,10	1	208008
	IAS adapter, IAS-S-ZA/Herkules for connection of IAS 2/IAS 3 suction hoses to Herkules central suction system; with closing slide	490605	1	134,70	1	208008

* Attention: Festool products with Bluetooth® technology are not available in all countries.
 For more information, please contact the official local Festool import partner.
 You can find the overview regarding our products and our partners worldwide on our website www.festool.com

PU = Packaging Units
 SU = Shipping Units

¹⁾ Manufacturer's recommended retail price.
 Dealer prices may vary.

Workplace organisation

Denomination and application

Order no. PU Trade price
€ excl. VAT SU DG
per PU ¹⁾

plug it-system

plug it



plug it-cable, H05 RN-F-4 rubber insulated cable 240V plug it length 4 m	203914	1	23,10	1	297001
---	--------	---	-------	---	--------

plug it-cable, H05 RN-F-4/3 rubber insulated cable 240V plug it length 4 m	203935	3	44,80	1	297001
---	--------	---	-------	---	--------

plug it-cable, H05 RN-F-5,5 rubber insulated cable 240V plug it length 5,5 m	203899	1	25,30	1	297001
---	--------	---	-------	---	--------

plug it-cable, H05 RN-F-7,5 rubber insulated cable 240V plug it length 7,5 m	203920	1	28,20	1	297001
---	--------	---	-------	---	--------

plug it-cable, H05 RN-F-10 rubber insulated cable 240V plug it length 10 m	203937	1	36,20	1	297001
---	--------	---	-------	---	--------



plug it-cable, H05 RN-F-4 PLANEX for the PLANEX LHS 2 225 EQ(I), PLANEX 225 EQ and PLANEX LHS-E 225 easy long-reach sanders; rubber insulated cable 240V plug it; particularly suitable for use with the PLANEX LHS 225 thanks to extended cable bushing, for example for sanding work in dry construction length 4 m	203929	1	23,90	1	297001
--	--------	---	-------	---	--------



plug it-cable, H05 BQ-F-4 green rubber-insulated cable length 4 m	203921	1	32,40	1	297001
--	--------	---	-------	---	--------

plug it-cable, H05 BQ-F-7,5 green rubber-insulated cable length 7,5 m	203922	1	42,40	1	297001
--	--------	---	-------	---	--------



plug it conversion-kit, UBS-PUR 360 plug it 240 V For RS1, RS 1 C, DX 93, RO 150/RO2, RAS 115, BF 1, PS 200/PS/2, KF 4 length 360 mm	491144	1	22,10	1	297001
---	--------	---	-------	---	--------



plug it conversion-kit, UBS-PUR 420 plug it 240 V For RS 2, RS 3, RS 400/RS 4, DS 400, ES 125, OF 1000, OF 900, ATF 55, AT 65, AP 55, AP 65, EHL 65 length 420 mm	491145	1	22,10	1	297001
--	--------	---	-------	---	--------

* Attention: Festool products with Bluetooth® technology are not available in all countries.
For more information, please contact the official local Festool import partner.
You can find the overview regarding our products and our partners worldwide on our website www.festool.com

PU = Packaging Units
SU = Shipping Units

¹⁾ Manufacturer's recommended retail price.
Dealer prices may vary.

Denomination and application	Order no.	PU	Trade price € excl. VAT per PU ¹⁾	SU	DG
------------------------------	-----------	----	--	----	----

Fan merchandise clothing men



Hoodie

Hoodie, Festool XS Festool hoodie for genuine fans; Material: 80% Cotton, 20% Polyester; Hoodie with drawstring cord in green; Wicking interior and front kangaroo pocket; Knitted cuffs on waist and sleeves; colour: dark blue with Festool printed on the left breast and the back in carton	202849	1	28,70	1	397003
Hoodie, Festool S Festool hoodie for genuine fans; Material: 80% Cotton, 20% Polyester; Hoodie with drawstring cord in green; Wicking interior and front kangaroo pocket; Knitted cuffs on waist and sleeves; colour: dark blue with Festool printed on the left breast and the back in carton	201300	1	28,70	1	397003
Hoodie, Festool M Festool hoodie for genuine fans; Material: 80% Cotton, 20% Polyester; Hoodie with drawstring cord in green; Wicking interior and front kangaroo pocket; Knitted cuffs on waist and sleeves; colour: dark blue with Festool printed on the left breast and the back in carton	201301	1	28,70	1	397003
Hoodie, Festool L Festool hoodie for genuine fans; Material: 80% Cotton, 20% Polyester; Hoodie with drawstring cord in green; Wicking interior and front kangaroo pocket; Knitted cuffs on waist and sleeves; colour: dark blue with Festool printed on the left breast and the back in carton	201302	1	28,70	1	397003
Hoodie, Festool XL Festool hoodie for genuine fans; Material: 80% Cotton, 20% Polyester; Hoodie with drawstring cord in green; Wicking interior and front kangaroo pocket; Knitted cuffs on waist and sleeves; colour: dark blue with Festool printed on the left breast and the back in carton	201303	1	28,70	1	397003
Hoodie, Festool XXL Festool hoodie for genuine fans; Material: 80% Cotton, 20% Polyester; Hoodie with drawstring cord in green; Wicking interior and front kangaroo pocket; Knitted cuffs on waist and sleeves; colour: dark blue with Festool printed on the left breast and the back in carton	201304	1	28,70	1	397003

* Attention: Festool products with Bluetooth® technology are not available in all countries.
 For more information, please contact the official local Festool import partner.
 You can find the overview regarding our products and our partners worldwide on our website www.festool.com

PU = Packaging Units
 SU = Shipping Units

¹⁾ Manufacturer's recommended retail price.
 Dealer prices may vary.



	Denomination and application	Order no.	PU	Trade price		
				€ excl. VAT	SU	DG
				per PU ¹⁾		
	Soft shell jacket, men					
	Soft shell jacket, men, Festool S material: 100% polyester – 300 g/m ² ; watertightness: 5000 mm; breathability: 3000 g/m ² /24 h; ergonomic sleeve shape for optimal freedom of movement; adjustable and removable hood; adjustable cuffs with hook-and-loop fastener; breast pocket and inside pocket, both with zip in carton	204056	1	73,00	1	397003
	Soft shell jacket, men, Festool M material: 100% polyester – 300 g/m ² ; watertightness: 5000 mm; breathability: 3000 g/m ² /24 h; ergonomic sleeve shape for optimal freedom of movement; adjustable and removable hood; adjustable cuffs with hook-and-loop fastener; breast pocket and inside pocket, both with zip in carton	204057	1	73,00	1	397003
	Soft shell jacket, men, Festool L material: 100% polyester – 300 g/m ² ; watertightness: 5000 mm; breathability: 3000 g/m ² /24 h; ergonomic sleeve shape for optimal freedom of movement; adjustable and removable hood; adjustable cuffs with hook-and-loop fastener; breast pocket and inside pocket, both with zip in carton	204058	1	73,00	1	397003
	Soft shell jacket, men, Festool XL material: 100% polyester – 300 g/m ² ; watertightness: 5000 mm; breathability: 3000 g/m ² /24 h; ergonomic sleeve shape for optimal freedom of movement; adjustable and removable hood; adjustable cuffs with hook-and-loop fastener; breast pocket and inside pocket, both with zip in carton	204059	1	73,00	1	397003
	Soft shell jacket, men, Festool XXL material: 100% polyester – 300 g/m ² ; watertightness: 5000 mm; breathability: 3000 g/m ² /24 h; ergonomic sleeve shape for optimal freedom of movement; adjustable and removable hood; adjustable cuffs with hook-and-loop fastener; breast pocket and inside pocket, both with zip in carton	204060	1	73,00	1	397003
	Soft shell jacket, men, Festool XXXL material: 100% polyester – 300 g/m ² ; watertightness: 5000 mm; breathability: 3000 g/m ² /24 h; ergonomic sleeve shape for optimal freedom of movement; adjustable and removable hood; adjustable cuffs with hook-and-loop fastener; breast pocket and inside pocket, both with zip in carton	204061	1	73,00	1	397003
	Sweatshirt, men					
	Sweatshirt, Festool S colour: Blue melange/blue; material: Main material: 100% knitted polyester fleece, knitted exterior, microfleece interior, 260 gr/m ² ; material: Lining: 100% polyester softshell with anti-odour finish, 260 gr/m ² ; two side welt pockets; zip in contrasting green with chin protection in carton	204008	1	53,00	1	397003
	Sweatshirt, Festool M colour: Blue melange/blue; material: Main material: 100% knitted polyester fleece, knitted exterior, microfleece interior, 260 gr/m ² ; material: Lining: 100% polyester softshell with anti-odour finish, 260 gr/m ² ; two side welt pockets; zip in contrasting green with chin protection in carton	204009	1	53,00	1	397003
	Sweatshirt, Festool L colour: Blue melange/blue; material: Main material: 100% knitted polyester fleece, knitted exterior, microfleece interior, 260 gr/m ² ; material: Lining: 100% polyester softshell with anti-odour finish, 260 gr/m ² ; two side welt pockets; zip in contrasting green with chin protection in carton	204010	1	53,00	1	397003
	Sweatshirt, Festool XL colour: Blue melange/blue; material: Main material: 100% knitted polyester fleece, knitted exterior, microfleece interior, 260 gr/m ² ; material: Lining: 100% polyester softshell with anti-odour finish, 260 gr/m ² ; two side welt pockets; zip in contrasting green with chin protection in carton	204012	1	53,00	1	397003
	Sweatshirt, Festool XXL colour: Blue melange/blue; material: Main material: 100% knitted polyester fleece, knitted exterior, microfleece interior, 260 gr/m ² ; material: Lining: 100% polyester softshell with anti-odour finish, 260 gr/m ² ; two side welt pockets; zip in contrasting green with chin protection in carton	204013	1	53,00	1	397003
	Sweatshirt, Festool XXXL colour: Blue melange/blue; material: Main material: 100% knitted polyester fleece, knitted exterior, microfleece interior, 260 gr/m ² ; material: Lining: 100% polyester softshell with anti-odour finish, 260 gr/m ² ; two side welt pockets; zip in contrasting green with chin protection in carton	204014	1	53,00	1	397003

* Attention: Festool products with Bluetooth® technology are not available in all countries.
For more information, please contact the official local Festool import partner.
You can find the overview regarding our products and our partners worldwide on our website www.festool.com

PU = Packaging Units
SU = Shipping Units

¹⁾ Manufacturer's recommended retail price.
Dealer prices may vary.

Fan merchandise





	Denomination and application	Order no.	PU	Trade price		
				€ excl. VAT	SU	DG
				per PU ¹⁾		
	Crew neck T-Shirt men					
	Crew neck T-Shirt men, Festool S light-weight crew neck T-shirt; material: 95% cotton – 5% elastane. 200 g/m ² ; high-quality, fine cotton; ideal dimensional stability thanks to elastane; pleasantly soft carrying sensation; easy-care; Festool logo on the front and rear in carton	204015	1	14,60	1	397003
	Crew neck T-Shirt men, Festool M light-weight crew neck T-shirt; material: 95% cotton – 5% elastane. 200 g/m ² ; high-quality, fine cotton; ideal dimensional stability thanks to elastane; pleasantly soft carrying sensation; easy-care; Festool logo on the front and rear in carton	204016	1	14,60	1	397003
	Crew neck T-Shirt men, Festool L light-weight crew neck T-shirt; material: 95% cotton – 5% elastane. 200 g/m ² ; high-quality, fine cotton; ideal dimensional stability thanks to elastane; pleasantly soft carrying sensation; easy-care; Festool logo on the front and rear in carton	204017	1	14,60	1	397003
	Crew neck T-Shirt men, Festool XL light-weight crew neck T-shirt; material: 95% cotton – 5% elastane. 200 g/m ² ; high-quality, fine cotton; ideal dimensional stability thanks to elastane; pleasantly soft carrying sensation; easy-care; Festool logo on the front and rear in carton	204018	1	14,60	1	397003
	Crew neck T-Shirt men, Festool XXL light-weight crew neck T-shirt; material: 95% cotton – 5% elastane. 200 g/m ² ; high-quality, fine cotton; ideal dimensional stability thanks to elastane; pleasantly soft carrying sensation; easy-care; Festool logo on the front and rear in carton	204019	1	14,60	1	397003
	Crew neck T-Shirt men, Festool XXXL light-weight crew neck T-shirt; material: 95% cotton – 5% elastane. 200 g/m ² ; high-quality, fine cotton; ideal dimensional stability thanks to elastane; pleasantly soft carrying sensation; easy-care; Festool logo on the front and rear in carton	204020	1	14,60	1	397003
	Training shirt men					
	Training shirt men, Festool S ultralight, quick-drying and breathable; material: 100% polyester, 140 gr/m ² ; shirt in blue with green darts; reflective label on back around neck in carton	204002	1	17,70	1	397003
	Training shirt men, Festool M ultralight, quick-drying and breathable; material: 100% polyester, 140 gr/m ² ; shirt in blue with green darts; reflective label on back around neck in carton	204003	1	17,70	1	397003
	Training shirt men, Festool L ultralight, quick-drying and breathable; material: 100% polyester, 140 gr/m ² ; shirt in blue with green darts; reflective label on back around neck in carton	204004	1	17,70	1	397003
	Training shirt men, Festool XL ultralight, quick-drying and breathable; material: 100% polyester, 140 gr/m ² ; shirt in blue with green darts; reflective label on back around neck in carton	204005	1	17,70	1	397003
	Training shirt men, Festool XXL ultralight, quick-drying and breathable; material: 100% polyester, 140 gr/m ² ; shirt in blue with green darts; reflective label on back around neck in carton	204006	1	17,70	1	397003
	Training shirt men, Festool XXXL ultralight, quick-drying and breathable; material: 100% polyester, 140 gr/m ² ; shirt in blue with green darts; reflective label on back around neck in carton	204007	1	17,70	1	397003
	Polo-Shirt dark blue men					
	Polo-Shirt dark blue men, Festool S Colour: Dark blue; 100% Cotton, combed; straight cut; green stripes on ribbed neck and cuffs; high-quality 3D Festool logo print on left sleeve; side slits on lower hem in carton	498452	1	35,00	1	397003
	Polo-Shirt dark blue men, Festool M Colour: Dark blue; 100% Cotton, combed; straight cut; green stripes on ribbed neck and cuffs; high-quality 3D Festool logo print on left sleeve; side slits on lower hem in carton	498453	1	36,20	1	397003
	Polo-Shirt dark blue men, Festool L Colour: Dark blue; 100% Cotton, combed; straight cut; green stripes on ribbed neck and cuffs; high-quality 3D Festool logo print on left sleeve; side slits on lower hem in carton	498454	1	36,20	1	397003

* Attention: Festool products with Bluetooth® technology are not available in all countries.
For more information, please contact the official local Festool import partner.
You can find the overview regarding our products and our partners worldwide on our website www.festool.com

PU = Packaging Units
SU = Shipping Units

¹⁾ Manufacturer's recommended retail price.
Dealer prices may vary.

Fan merchandise





Denomination and application		Order no.	PU	Trade price € excl. VAT per PU ¹⁾	SU	DG
	Polo-Shirt dark blue men, Festool XL Colour: Dark blue; 100% Cotton, combed; straight cut; green stripes on ribbed neck and cuffs; high-quality 3D Festool logo print on left sleeve; side slits on lower hem in carton	498455	1	36,20	1	397003
	Polo-Shirt dark blue men, Festool XXL Colour: Dark blue; 100% Cotton, combed; straight cut; green stripes on ribbed neck and cuffs; high-quality 3D Festool logo print on left sleeve; side slits on lower hem in carton	498456	1	36,20	1	397003
Snickers winter jacket men						
	Snickers winter jacket men, Festool S men's winter jacket from Original Snickers Workwear, with specially tailored sleeves to support the natural working position; 100% Polyester; water- and oil-repellent with robust outer fabric; soft quilted lining for optimal insulation and comfortable to wear; total of 3 inner pockets, two of which can be closed (1x snap fastener, 1x with zip); with embroidered Festool logo on the front and back; Colour: Dark blue in carton	497902	1	91,30	1	397003
	Snickers winter jacket men, Festool M men's winter jacket from Original Snickers Workwear, with specially tailored sleeves to support the natural working position; 100% Polyester; water- and oil-repellent with robust outer fabric; soft quilted lining for optimal insulation and comfortable to wear; total of 3 inner pockets, two of which can be closed (1x snap fastener, 1x with zip); with embroidered Festool logo on the front and back; Colour: Dark blue in carton	497903	1	94,50	1	397003
Fan merchandise for leisure time and sports						
Golf cap						
	Golf cap, Festool Sporty cap with embroidered Festool writing and www.festool.com; bent front cover with green stripe; width adjustment at back for optimal fit; Colour: Dark blue in carton	497899	1	9,90	1	397003
Pocket knife						
	Victorinox penknife, Festool original Victorinox penknife with 12 functions, including two blades, a wood saw and screwdriver; large blade, small blade, corkscrew; can opener with small screwdriver; bottle opener with screwdriver and wire stripper; reamer, keyring, tweezers, toothpick, wood saw; Colour: Dark blue with embossed cross, Festool logo in green and www.festool.com	497898	1	24,70	1	397003
Backpack						
	Backpack, Festool outer material: 840D two-tone polyester, laminated with PUR; inner material: Polyester 400D; main compartment dimensions: 50 cm x 28 cm; capacity: Approx. 25 l; opening for the drinking system and additional bottle holder; padded laptop compartment; inside compartments for storage; net pockets on both sides; tarpaulin base provides protection from dirt and moisture; ergonomic carrying system with adjustable straps and padding; height adjustable chest strap and additional waist strap; padded lid to better protect the contents; long zips enable the compartments to be opened widely; light-coloured inner material ensures a consistently good overview in carton	203993	1	54,80	1	397003
Sports bag						
	Sports bag, Festool Robust sports bag with green decorative stitching and embossed logo on side pockets; large main compartment, inner compartment with Velcro fastening and separate compartment for wet items; extra-reinforced base and sewn-on plastic pyramid feet on bottom for even more stability; adjustable carrier straps; 50 x 30 x 30 cm; Colour: Dark blue with green decorative stitching; black side pockets with embossed logo; volume: approx. 45 l in carton	498494	1	41,30	1	397003

* Attention: Festool products with Bluetooth® technology are not available in all countries.
 For more information, please contact the official local Festool import partner.
 You can find the overview regarding our products and our partners worldwide on our website www.festool.com

PU = Packaging Units
 SU = Shipping Units

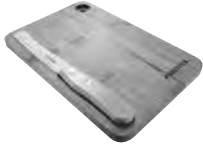
¹⁾ Manufacturer's recommended retail price.
 Dealer prices may vary.

Fan merchandise



Denomination and application		Order no.	PU	Trade price € excl. VAT per PU ¹⁾	SU	DG
Festool Fan babygrow						
	"Festool Fan" babygrow, Festool Size 68; Babygrow in blue; Festool Fan logo on the breast; short sleeves; American collar; three green snap fasteners in the crotch; Material: 100% cotton; Production in accordance with the Oeko-Tex standard	202307	1	12,30	1	397003
Knitted hat						
	Knitted hat, Festool knitted hat in blue; breathable with very good insulating properties; material: 100% acrylic; Production in accordance with the Oeko-Tex standard	202308	1	11,60	1	397003
Snack Set						
	Snack Set, Festool blade material: Stainless steel, plastic; cutting board material: Bamboo; dimensions: 240 x 160 x 12 mm; all-purpose serrated blade; wooden cutting board with magnetic holder for blades in carton	203992	1	14,10	1	397003
Insulated bag						
	Insulated bag, ISOT-FT1 suitable for Systainer ³ M 187; storage in a Systainer ³ ; can be stacked in the system and good protection for the bag; made of heavy-duty and water-resistant 480D polyester fabric, PU-coated, with high tear resistance; large opening with YKK zip fastener; two inner net pockets for cooling batteries; two shoulder straps can be individually attached in six suspension lugs for flexible carrying options; not washable, wipe out with a damp cloth volume 11 l; dimensions (L x W x H) 340 x 250 x 130 mm; in carton	576978	1	26,60	1	397003
Cutlery						
	Cutlery, BST-LCH FT1 well-designed To-Go cutlery for the construction site or for picnics, in the usual size, robust and can be connected in a compact way; the koziol ORGANIC Collection consists of natural cellulose: Environmentally friendly, 100% recyclable, without formaldehyde or BPA, suitable for use with foodstuffs, tasteless, dishwasher-safe and extremely durable in carton	576979	1	8,30	1	397003
Lunch box						
	Lunch box, BOX-LCH FT1 S compact "S" lunch box by koziol, high-quality lunch box with practical clip closure, fits two in the "L" lunch box; the koziol ORGANIC Collection consists of natural cellulose: Environmentally friendly, 100% recyclable, without formaldehyde or BPA, suitable for use with foodstuffs, tasteless, dishwasher-safe and extremely durable dimensions (L x W x H) 151 x 108 x 60 mm; in carton	576980	1	5,20	1	397003
	Lunch box, BOX-LCH FT1 L "L" lunch box by koziol, voluminous, high-quality lunch box with practical clip closure with plenty of storage space for bread, fruit, vegetables and much more; the koziol ORGANIC Collection consists of natural cellulose: Environmentally friendly, 100% recyclable, without formaldehyde or BPA, suitable for use with foodstuffs, tasteless, dishwasher-safe and extremely durable dimensions (L x W x H) 232 x 166 x 62 mm; in carton	576981	1	13,50	1	397003

* Attention: Festool products with Bluetooth® technology are not available in all countries.
 For more information, please contact the official local Festool import partner.
 You can find the overview regarding our products and our partners worldwide on our website www.festool.com

PU = Packaging Units
 SU = Shipping Units



¹⁾ Manufacturer's recommended retail price.
 Dealer prices may vary.

Fan merchandise

Denomination and application		Order no.	PU	Trade price € excl. VAT per PU ¹⁾	SU	DG
Drinks bottle						
	Drinks bottle, TFL-FT1 1L 720°DGREE 1000 ml water bottle with strainer and spare seal set; also leak-proof for fizzy drinks, innovative anti-glug drink opening; housing material: BPA-free tritan, lid: BPA-free polypropylene/silicone; perfect to use with only one hand – thanks to the 1-CLICK drinks cap height 285 mm; Product weight 0.225 kg; diameter 78 mm; in carton	576982	1	18,60	1	397003
	Drinks bottle, TFL-FT1 1,5L 720°DGREE 1500 ml water bottle with strainer and spare seal set; also leak-proof for fizzy drinks, innovative anti-glug drink opening; housing material: BPA-free tritan, lid: BPA-free polypropylene/silicone; perfect to use with only one hand – thanks to the 1-CLICK drinks cap height 287 mm; Product weight 0.265 kg; diameter 98 mm; in carton	576983	1	20,70	1	397003

Key tool						
	Key tool, KT-TPC-FT1 compact key tool in the shape of the Festool TPC; made from high-quality, sandblasted stainless steel; an essential accessory for every set of keys and combines eight functions in the smallest of spaces	577221	1	6,10	1	397003

Fan merchandise office









Pencil set						
	Pencil set, Festool Set of four pens in a cardboard case; HB pencils for writing, drawing and sketching; clever design with blue paint and green Festool logo; with printing Festool and www.festool.com; made in Germany	497892	1	4,10	1	397003
Notebook						
	Notebook, Festool Large hardback notebook with 200 pages; The dimensionally stable hardback notebook offers lots of space for notes, thoughts and ideas; DIN A4; 200 pages, chequered; incl. bookmark; Colour: Dark blue with printed Festool logo in carton	498866	1	14,90	1	397003

Thermal cup						
	Insulated mug, Festool capacity: 450 ml; folding lid protects the drinking opening from dirt and insulates; snap fastener with safety seal enables one-handed operation; bottle material: Stainless steel, double-walled; drinking opening material: PP; cap material: TPE and silicon; free from BPA; do not clean in the dishwasher in self-service display pack	203065	1	14,50	1	397003

Fan merchandise workshop

Working knife						
	Working knife, Festool Blade length: 8.5 cm; Total length (open): 20 cm; Handle material: Olive wood; Blade material: 3Cr13 stainless steel; with safety lock	203994	1	12,40	1	397003



Fan merchandise

Denomination and application		Order no.	PU	Trade price € excl. VAT per PU ¹⁾	SU	DG
Safety cutter knife						
	Safety cutter knife, Festool Safety cutting knife with automatic retraction of blade when not used; suitable for left and right handers in equal measure; soft grip with pimples on surface for optimal handling and secure grip; blade width: 18 mm; blade length: 60 mm; Colour: Dark blue with black handle and green Festool logo; metal housing	498183	1	9,90	1	397003
Tape measure						
	Tape measure, MB 5m robust 5 m tape measure with sturdy belt clip and automatic roller system; flexible operation using the stop button on the underside of the tape measure; the rubberised plastic housing fits perfectly in your hand, the strap can be used to hold it and to hang it up; horizontal stability; adjustable end hook for more precision; Colour: Dark blue with printed Festool logo; plastic housing, metal tape measure; printed on both sides	205182	1	13,70	1	397003
Yardstick						
	Yardstick, Festool Quality standard with closely arranged links and joints made from hardened sheet steel with integrated precision springs; Manufacturer: STABILA, Germany; Colour: Dark blue protective coating, unsurpassed weather- and abrasion-resistance with printed Festool logo and www.festool.com; 2-metre wooden folding yardstick, 10 links; wood material, joints with hardened inner steel spring in carton	201464	1	4,30	1	397003
Toolie multi function tool						
	Toolie multi function tool, Festool Practical hexagon spherical head tool for almost every screwing situation; stable, ergonomic housing with button for simple selection of desired blade; includes 9 hexagon socket wrenches with MagicRing SW 2.5/4.0/5.0/7.0 - TX T10/T15/T20 - PZ2 - slot 4.5; 12 cm long; Colour: Dark blue with green buttons and printed Festool logo	498863	1	25,70	1	397003
Safety glasses						
	UVEX Safety glasses, Festool Original UVEX safety goggles uvex i-vo; Duo-Component Technology for outstanding working comfort: soft components around sensitive areas (nose, forehead, ear) prevent pressure marks; Quattroflex side pieces with inclination and length adjustment option; lenses with scratch-proof exterior and anti-fog interior, colourless/UV 2-1.2, supravision HC-AF coating. Easy lens replacement; Colour: Frame blue/green with Festool logo in carton	500119	1	18,30	1	397003
Pin						
	Pica pencil, L the refillable Zimmermann mechanical pencil – extremely sturdy and durable; with lead sharpener for marking with millimetre precision; automatic lead feed at the push of a button; can be refilled with different replacement lead (2 x 5 mm cross section), for a wide range of applications; NEW: Hexagonal bit holder in the quiver cap	205278	1	18,00	1	397003
	Pica pencil, MAR-S PICA the "FOR ALL" 2B graphite lead enables you to make markings on the surface of almost any material. No matter whether it is dry or wet, smooth or rough, dusty or oily; can be wiped from smooth surfaces with a damp cloth; for light or dark surfaces; integrated sharpener in the quiver cap ; pressure mechanism for automatic lead feed in the stainless steel tube; lead diameter: 2.8 mm in carton	204147	1	14,60	1	397003
Contour gauge						
	Contour gauge, KTL-FZ FT1 duplicator for copying and transferring shapes and contours; ideal template for every tradesperson, simple handling; material: ABS plastic (Acrylonitrile butadien styrene) dimensions (L x W x H) 145 x 105 x 20 mm; in carton	576984	1	10,40	1	397003

* Attention: Festool products with Bluetooth® technology are not available in all countries.
 For more information, please contact the official local Festool import partner.
 You can find the overview regarding our products and our partners worldwide on our website www.festool.com

PU = Packaging Units
 SU = Shipping Units

¹⁾ Manufacturer's recommended retail price.
 Dealer prices may vary.

Denomination and application	Order no.	PU	Trade price € excl. VAT per PU ¹⁾	SU	DG
Shoe covers					
 <p>Shoe covers, SHOE-FT1 shoe covers for clean working (e.g. kitchen assembly, ...) ; reusable, washable by hand, conveniently packed in a zipping cord bag for further storage; universal size - one size fits all, with anti-slip sole; material: waterproof polyester (bag: microfibre); size: 35 x 22 x 3 cm (bag: 20 x 22 cm)</p>	577003	1	7,20	1	397003
Tool belt					
 <p>Tool belt, TB-FT1 heavy-duty tool belt for availability of tools easy to reach; belt and shoulder strap adjustable for high comfort while working; tool bag with many pockets and storage options; hammer and cordless screwdriver holder for best possible fit; material: polyester, metal- & plastic parts</p>	577154	1	88,40	1	397003